

---

# Turbo V Ion Source

## Operator Guide



---

This document is provided to customers who have purchased SCIEX equipment to use in the operation of such SCIEX equipment. This document is copyright protected and any reproduction of this document or any part of this document is strictly prohibited, except as SCIEX may authorize in writing.

Software that may be described in this document is furnished under a license agreement. It is against the law to copy, modify, or distribute the software on any medium, except as specifically allowed in the license agreement. Furthermore, the license agreement may prohibit the software from being disassembled, reverse engineered, or decompiled for any purpose. Warranties are as stated therein.

Portions of this document may make reference to other manufacturers and/or their products, which may contain parts whose names are registered as trademarks and/or function as trademarks of their respective owners. Any such use is intended only to designate those manufacturers' products as supplied by SCIEX for incorporation into its equipment and does not imply any right and/or license to use or permit others to use such manufacturers' and/or their product names as trademarks.

SCIEX warranties are limited to those express warranties provided at the time of sale or license of its products and are the sole and exclusive representations, warranties, and obligations of SCIEX. SCIEX makes no other warranty of any kind whatsoever, expressed or implied, including without limitation, warranties of merchantability or fitness for a particular purpose, whether arising from a statute or otherwise in law or from a course of dealing or usage of trade, all of which are expressly disclaimed, and assumes no responsibility or contingent liability, including indirect or consequential damages, for any use by the purchaser or for any adverse circumstances arising therefrom.

(GEN-IDV-09-10816-D)

For Research Use Only. Not for use in Diagnostic Procedures.

Trademarks and/or registered trademarks mentioned herein, including associated logos, are the property of AB Sciex Pte. Ltd., or their respective owners, in the United States and/or certain other countries (see [sciex.com/trademarks](http://sciex.com/trademarks)).

AB Sciex™ is being used under license.

© 2022 DH Tech. Dev. Pte. Ltd.



AB Sciex Pte. Ltd.  
Blk33, #04-06 Marsiling Industrial Estate Road 3  
Woodlands Central Industrial Estate, Singapore 739256

# Contents

---

<b>1 Operational Precautions and Limitations</b> .....	<b>6</b>
Operational Precautions and Hazards.....	6
Chemical Precautions.....	7
System Safe Fluids.....	8
Laboratory Conditions.....	9
Safe Environmental Conditions.....	9
Performance Specifications.....	9
Equipment Use and Modification.....	9
<b>2 Ion Source Overview</b> .....	<b>11</b>
Ionization Modes.....	11
ESI Mode.....	11
APCI Mode.....	12
Ion Source Components.....	13
Probes.....	14
TurbolonSpray Probe.....	14
APCI Probe.....	15
Gas and Electrical Connections.....	16
Ion Source Sense Circuit.....	16
Source Exhaust System.....	17
<b>3 Ion Source Installation</b> .....	<b>19</b>
Prepare for Installation.....	19
Install the Probe.....	20
Connect the Ion Source Tubing.....	21
Install the Ion Source on the Mass Spectrometer.....	21
Sample Inlet Requirements.....	23
Inspect for Leaks.....	23
<b>4 Ion Source Optimization</b> .....	<b>24</b>
Sample Introduction.....	24
Method.....	24
Flow Rate.....	25
TurbolonSpray Probe Optimization.....	25
Flow Rate and Ion Source Temperature.....	26
Set Up the System for Tee Infusion.....	26

## Contents

---

Optimize the TurbolonSpray Probe Position.....	27
Optimize Source and Gas Parameters and Voltage.....	29
Source Optimization Procedures (SCIEX OS).....	30
Optimize the Turbo Heater Temperature.....	32
Optimization Tips.....	32
<b>5 Ion Source Maintenance.....</b>	<b>34</b>
Recommended Maintenance Schedule.....	35
Ion Source Handling.....	36
Remove the Ion Source.....	37
Clean the Ion Source Surfaces.....	38
Clean the Probe.....	38
Remove the Probe.....	39
Replace the Electrode.....	39
Replace the Corona Discharge Needle.....	41
Replace the Sample Tubing.....	43
Storage and Handling.....	43
<b>6 Ion Source Troubleshooting.....</b>	<b>44</b>
<b>A Principles of Operation — Ion Source.....</b>	<b>48</b>
Electrospray Ionization Mode.....	48
APCI Mode.....	49
APCI Ionization Region.....	52
<b>B Source Parameters and Voltages.....</b>	<b>54</b>
TurbolonSpray Probe Parameters.....	54
APCI Probe Parameters.....	55
Parameter Descriptions.....	56
Probe Position.....	58
Solvent Composition.....	58
<b>C Ion Source Optimization (Analyst/Analyst TF Software).....</b>	<b>60</b>
TurbolonSpray Probe Optimization.....	60
Set Up the System.....	61
Prepare the System.....	61
Set the Starting Conditions.....	61
APCI Probe Optimization.....	62
Set Up the System.....	63
Prepare the System.....	63
Set the Starting Conditions.....	64
Optimize Source and Gas Parameters.....	64

Adjust the Position of the Corona Discharge Needle .....	65
Optimize the APCI Probe Position .....	65
Optimize the Nebulizer Current .....	67
Optimize the APCI Probe Temperature .....	68
<b>D Glossary of Symbols .....</b>	<b>69</b>
<b>Contact Us .....</b>	<b>75</b>
Customer Training .....	75
Online Learning Center .....	75
SCIEX Support .....	75
CyberSecurity .....	75
Documentation .....	75

# Operational Precautions and Limitations

# 1

---

**Note:** Before operating the system, carefully read all of the sections of this guide.

---

This section contains general safety-related information. It also describes potential hazards and associated warnings for the system and the precautions that should be taken to minimize the hazards.

For information about the symbols and conventions used in the laboratory environment, on the system, and in this documentation, refer to the section: [Glossary of Symbols](#).

## Operational Precautions and Hazards

For regulatory and safety information for the mass spectrometer, refer to the document: *System User Guide* or *Safety Practices Guide*.



---

**WARNING! Ionizing Radiation Hazard, Biohazard, or Toxic Chemical Hazard.** Do not use the ion source without knowledge of and training in the proper use, containment, and evacuation of toxic or injurious materials used with the ion source.

---



---

**WARNING! Hot Surface Hazard.** Let the Turbo V ion source cool for at least 30 minutes before starting any maintenance procedures. Some surfaces of the ion source and vacuum interface become hot during operation.

---



---

**WARNING! Puncture Hazard, Ionizing Radiation Hazard, Biohazard, or Toxic Chemical Hazard.** Discontinue use of the ion source if the ion source window is cracked or broken, and then contact a SCIEX Field Service Employee (FSE). Any toxic or injurious materials introduced in the equipment will be present in the source exhaust output. Exhaust from equipment should be vented from the room. Dispose of sharps following established laboratory safety procedures.

---



---

**WARNING! Toxic Chemical Hazard.** Wear personal protective equipment, including a laboratory coat, gloves, and safety glasses, to avoid skin or eye exposure.

---



**WARNING!** Ionizing Radiation Hazard, Biohazard, or Toxic Chemical Hazard. In the event of a chemical spill, review product safety data sheets for specific instructions. Make sure that the system is in Standby state before cleaning a spill near the ion source. Use appropriate personal protective equipment and absorbent wipes to contain the spill and dispose of it following local regulations.

---



**WARNING!** Environmental Hazard. Do not dispose of system components in municipal waste. Follow local regulations when disposing of components.

---



**WARNING!** Electrical Shock Hazard. Avoid contact with the high voltages applied to the ion source during operation. Put the system in Standby state before adjusting the sample tubing or other equipment near the ion source.

---

## Chemical Precautions



**WARNING!** Ionizing Radiation Hazard, Biohazard, or Toxic Chemical Hazard. Determine whether decontamination is required before cleaning or maintenance. If radioactive materials, biological agents, or toxic chemicals have been used with the system, then the customer must decontaminate the system before cleaning or maintenance.

---



**WARNING!** Environmental Hazard. Do not dispose of system components in municipal waste. Follow local regulations when disposing of components.

---



**WARNING!** Biohazard or Toxic Chemical Hazard. Connect the drain tubing to the mass spectrometer and the source exhaust drain bottle properly, to prevent leaks.

---

- Determine which chemicals have been used in the system prior to service and regular maintenance. For the health and safety precautions that must be followed for a chemical, refer to the document: *Safety Data Sheet*. For storage information, refer to the document: *Certificate of Analysis*. To find a *SCIEX Safety Data Sheet* or *Certificate of Analysis*, go to [sciex.com/tech-regulatory](http://sciex.com/tech-regulatory).
- Always wear assigned personal protective equipment, including powder-free gloves, safety glasses, and a laboratory coat.

---

**Note:** Nitrile or neoprene gloves are recommended.

---

- Work in a well-ventilated area or fume hood.
- Avoid ignition sources when working with flammable materials, such as isopropanol, methanol, and other flammable solvents.

## Operational Precautions and Limitations

---

- Take care in the use and disposal of any chemicals. There is a potential risk of personal injury if proper procedures for handling and disposal of chemicals are not followed.
- Avoid skin contact with chemicals during cleaning, and wash hands after use.
- Make sure that all exhaust hoses are connected properly and that all connections are functioning as designed.
- Collect all spent liquids and dispose of them as hazardous waste.
- Comply with all of the local regulations for the storage, handling, and disposal of biohazardous, toxic, and radioactive materials.

## System Safe Fluids

The following fluids can safely be used with the system.

---

**CAUTION: Potential System Damage. Do not use any other fluid until confirmation is received from SCIEX that it does not present a hazard. This is not an exhaustive list.**

---

- **Organic Solvents**
  - LC-MS-grade acetonitrile; up to 100%
  - LC-MS-grade methanol; up to 100%
  - LC-MS-grade isopropanol; up to 100%
  - LC-MS-grade or higher water; up to 100%
  - Tetrahydrofuran; up to 100%
  - Toluene and other aromatic solvents; up to 100%
  - Hexanes; up to 100%
- **Buffers**
  - Ammonium acetate; less than 100 mM
  - Ammonium formate; less than 100 mM
  - Phosphate; less than 1%
- **Acids and Bases**
  - Formic acid; less than 1%
  - Acetic acid; less than 1%
  - Trifluoroacetic acid (TFA); less than 1%
  - Heptafluorobutyric acid (HFBA); less than 1%
  - Ammonia/ammonium hydroxide; less than 1%



- Phosphoric acid; less than 1%
- Trimethylamine; less than 1%
- Triethylamine; less than 1%

## Laboratory Conditions

### Safe Environmental Conditions

The system is designed to operate safely under these conditions:

- Indoors
- Altitude: Up to 2,000 m (6,560 ft) above sea level
- Ambient temperature: 5 °C (41 °F) to 40 °C (104 °F)
- Relative humidity: 20% to 80%, non-condensing
- Mains supply voltage fluctuations:  $\pm 10\%$  of the nominal voltage
- Transient overvoltages: Up to the levels of Overvoltage Category II
- Temporary overvoltages on the mains supply
- Pollution Degree 2

### Performance Specifications

The system is designed to meet specifications under these conditions:

- An ambient temperature of 15 °C to 30 °C (59 °F to 86 °F)

Over time, the temperature must remain within a range of 4 °C (7.2 °F), with the rate of the change in temperature not exceeding 2 °C (3.6 °F) per hour. Ambient temperature fluctuations exceeding the limits might result in mass shifts in spectra.

- Relative humidity from 20% to 80%, non-condensing

## Equipment Use and Modification



---

**WARNING! Electrical Shock Hazard. Do not remove the covers. Removing the covers might cause injury or malfunctioning of the system. The covers need not be removed for routine maintenance, inspection, or adjustment. Contact a SCIEX Field Service Employee (FSE) for repairs that require the covers to be removed.**

---

## Operational Precautions and Limitations

---



**WARNING! Personal Injury Hazard. Use SCIEX-recommended parts only. Use of parts not recommended by SCIEX or use of parts for any purpose other than their intended purpose can put the user at risk of harm or negatively impact system performance.**

---

Use the system indoors in a laboratory that complies with the environmental conditions recommended in the mass spectrometer document: *Site Planning Guide*.

If the system is used in an environment or in a manner not prescribed by the manufacturer, then the performance and protection provided by the equipment might be impaired.

Unauthorized modification or operation of the system might cause personal injury and equipment damage, and might void the warranty. Erroneous data might be generated if the system is operated outside the recommended environmental conditions or with unauthorized modifications. Contact an FSE for information on servicing the system.

# Ion Source Overview

# 2

The Turbo V ion source can be used for either electrospray ionization (ESI) or atmospheric pressure chemical ionization (APCI).

The TurbolonSpray probe is used for ESI mode operation. The APCI probe is used for APCI mode operation.

Applications for the ion source include qualitative method development and qualitative and quantitative analysis.

The installation procedures can be performed on the following systems:

- TripleTOF systems
- QTRAP and SCIEX Triple Quad systems

In this guide, the software that controls the mass spectrometer is referred to as the control software. The control software varies depending on the mass spectrometer used. Refer to the following table.

**Table 2-1 Mass Spectrometers and Control Software**

Mass Spectrometer	Software
SCIEX Triple Quad 3500, API 4000, 4000 QTRAP, and API 5000 systems	Analyst software
SCIEX 4500, 5500, 5500+, 6500, and 6500+ systems	Analyst software or SCIEX OS software
TripleTOF 5600, 5600+, 6600, and 6600+ systems	Analyst TF software

## Ionization Modes

### ESI Mode

ESI produces gas phase ions of analytes in a sample by applying a high voltage to the sample effluent flowing through a needle. With the aid of heated gas flow, ESI produces singly and multiply charged ions in a relatively mild condition so that it is suitable for a wide range of compounds including small molecules, such as drugs or pesticides, and larger molecules, such as peptides, proteins, and other biopolymers. The sensitivity depends on the chemical properties of the analyte, the gas flow rate, the temperature, the voltage, and the mobile phase composition.

## Ion Source Overview

---

The ESI technique is mild enough to be used with labile compounds, such as peptides, proteins, and thermally labile pharmaceuticals. It functions with flow rates from 5  $\mu\text{L}/\text{min}$  to 3,000  $\mu\text{L}/\text{min}$  and it vaporizes 100% aqueous to 100% organic solvents.

Refer to the section: [Electrospray Ionization Mode](#).

## APCI Mode

The APCI mode is suitable for:

- Ionization of compounds that do not readily form ions in solution. These are usually non-polar compounds.
- Creation of simple APCI spectra for LC-MS/MS experiments.
- High-throughput analyses of complex and dirty samples. It is less sensitive to ion suppression effects.
- Rapid sample introduction by flow injection with or without an LC column.

The APCI technique can be used for volatile and thermally labile compounds with minimal thermal decomposition. The rapid desolvation and vaporization of the droplets and entrained analyte minimizes thermal decomposition and preserves molecular identity for ionization by the corona discharge needle. Buffers are readily tolerated by the ion source without significant contamination and the flash vaporization of the sprayed effluent allows up to 100% water to be used. The probe can accept the entire effluent, without splitting, at flow rates from 200  $\mu\text{L}/\text{min}$  to 3,000  $\mu\text{L}/\text{min}$ , through a wide-bore column.

Refer to the section: [APCI Mode](#).

# Ion Source Components

Figure 2-1 Ion Source Components

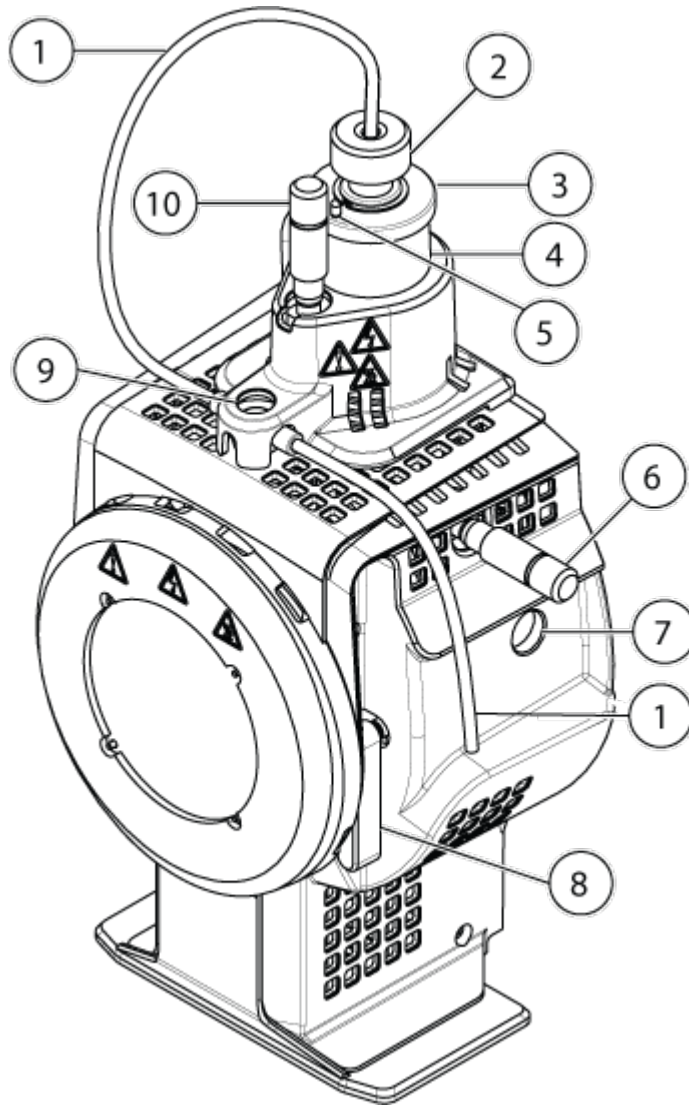

Item	Description	Primary Materials
1	Sample tubing from a sample supply device	Red PEEK
2	Electrode adjustment nut	Polyoxymethylene
3	Retaining ring	PEEK
4	Probe tower	Stainless steel

## Ion Source Overview

---

Item	Description	Primary Materials
5	Corona discharge needle adjustment screw	PEEK
6	Micrometer used to position the probe on the horizontal axis for ion source sensitivity adjustments	Glass
7	Window port	Stainless steel
8	One of two source latches that secure the ion source to the mass spectrometer	Stainless steel
9	Grounding union, located under the ion source cover.	Stainless steel
10	Micrometer used to position the probe on the vertical axis for ion source sensitivity adjustments	Polyoxymethylene

## Probes

The TurbolonSpray and APCI probes provide a range of capability for testing samples. Select the probe and method most suitable for the compounds in the sample.

**Table 2-2 Ion Source Specifications**

Specification	TurbolonSpray Probe	APCI Probe
Temperature range	From ambient temperature to 750 °C, depending on liquid flow	From ambient temperature to 750 °C, depending on liquid flow
Liquid flow inlet	5 µL/min to 3,000 µL/min	200 µL/min to 3,000 µL/min
Ion source gas 1 / ion source gas 2	Refer to the mass spectrometer document: <i>Site Planning Guide</i>	

The software for the mass spectrometer identifies the installed probe and enables the corresponding user controls. All of the data acquired using the ion source is identified with an abbreviation representing the probe used to acquire the data (TIS for the TurbolonSpray probe and HN for the APCI probe).

## TurbolonSpray Probe

The TurbolonSpray probe consists of 300 µm outer diameter (o.d.) (0.012 inch) stainless steel tubing. It is located centrally with the two turbo heaters placed at a 45 degree angle to each side. Samples introduced through the TurbolonSpray probe are ionized within the tubing, by the application of high voltage (**IonSpray Voltage** in the Analyst software, **IonSpray Voltage Floating** in the Analyst TF software, or **Spray voltage** in SCIEX OS). Then they are nebulized

by a jet of hot, dry, Zero-grade air from the turbo heaters, creating a mist of small, highly-charged droplets. The combination of the ion source effluent and the heated dry gas from the turbo sprayer is projected at a 90 degree angle to the ion path. Refer to the section: [Principles of Operation — Ion Source](#).



**WARNING! Puncture Hazard. Be careful when handling the electrode. The tips of the electrodes are extremely sharp.**

Figure 2-2 Parts of the TurbolonSpray Probe

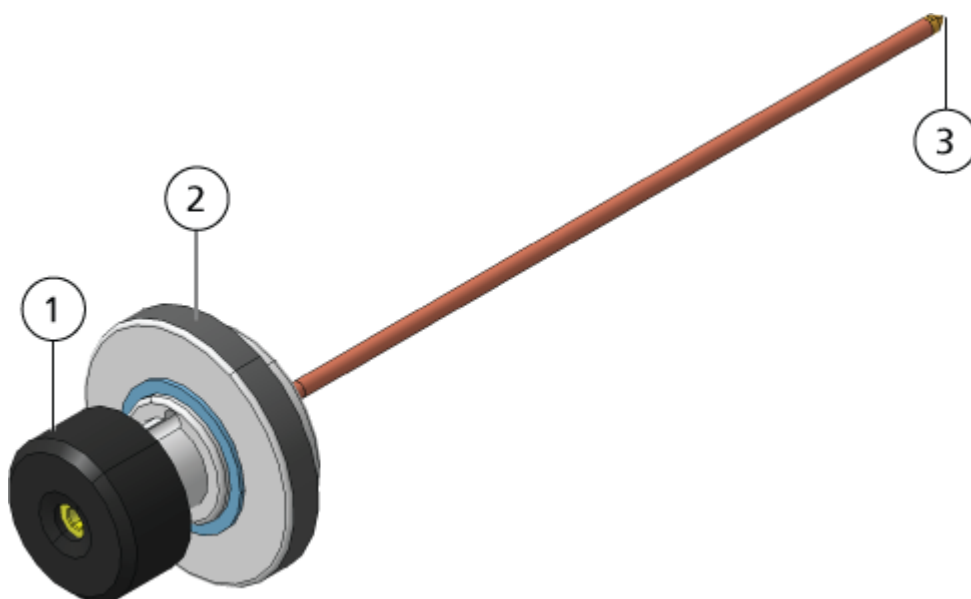

Item	Description
1	Electrode adjustment nut (black collar) that adjusts the extension of the electrode tip
2	Retaining ring that fastens the probe to the probe tower on the ion source housing
3	Electrode tip through which samples are sprayed in the sample inlet area of the ion source

## APCI Probe

The APCI probe consists of 100 µm inner diameter (i.d.) (0.004 inch) stainless steel tubing surrounded by a flow of nebulizer gas (Gas 1). The liquid sample stream is pumped through the sprayer, where it is nebulized in a ceramic tube containing a heater. The inner wall of the ceramic tube can be maintained at a temperature range of 100 °C to 750 °C and is monitored by the sensor embedded in the heater.

## Ion Source Overview

---

A high-velocity jet of nebulizer gas flows around the electrode tip to disperse the sample as a mist of fine particles. It moves through the ceramic vaporization heater to the reaction region of the ion source and then past the corona discharge needle where the sample molecules are ionized as they pass through the ion source housing. Refer to the section: [Principles of Operation — Ion Source](#).



**WARNING! Puncture Hazard. Be careful when handling the electrode. The tips of the electrodes are extremely sharp.**

---

Figure 2-3 Parts of the APCI Probe

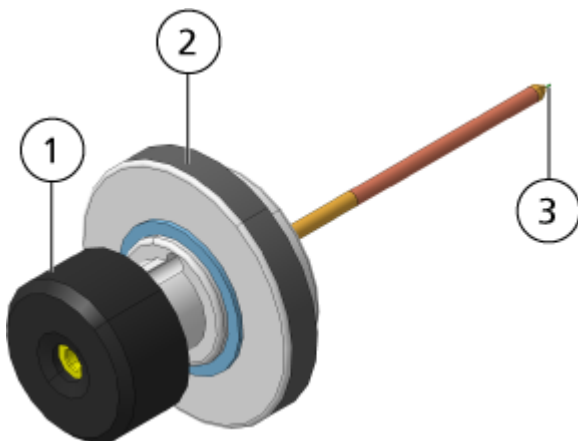

Item	Description
1	Electrode adjustment nut (black collar) that adjusts the extension of the electrode tip
2	Retaining ring that secures the probe in the probe tower
3	Electrode tip through which samples are sprayed in the sample inlet area of the ion source

## Gas and Electrical Connections

Gas and low- and high-voltage electrical connections are provided on the front plate of the vacuum interface and they connect internally through the ion source housing. When the ion source is installed on the mass spectrometer, all of the electrical and gas connections are complete.

## Ion Source Sense Circuit

An ion source sense circuit disables the high-voltage power supply for the mass spectrometer and the source exhaust system under these conditions:



- The ion source is not installed or is improperly installed.
- A probe is not installed.
- The mass spectrometer senses a gas fault.
- A turbo heater has failed.
- The ion source has overheated.

## Source Exhaust System



**WARNING! Ionizing Radiation Hazard, Biohazard, or Toxic Chemical Hazard.** Make sure that the source exhaust system is connected and functioning, to safely remove sample vapor exhaust from the laboratory environment. Emissions from the equipment must be exhausted in the general building exhaust and not allowed to exhaust in the workspace of the laboratory. For requirements for the source exhaust system, refer to the document: *Site Planning Guide*.



**WARNING! Ionizing Radiation Hazard, Biohazard, or Toxic Chemical Hazard.** Vent the source exhaust system to either a dedicated laboratory fume hood or an external ventilation system to prevent hazardous vapors from being released in the laboratory environment.



**WARNING! Ionizing Radiation Hazard, Biohazard, or Toxic Chemical Hazard.** If an LC system is used with the mass spectrometer, and if the source exhaust system is not functioning properly, then shut down the LC system until functionality of the source exhaust system has been restored.



**WARNING! Fire Hazard.** Do not direct more than 3 mL/min of flammable solvent in the ion source. Exceeding the maximum flow rate can cause solvent to accumulate in the ion source. Do not use the ion source if the source exhaust system is not enabled and functioning when the ion source and the probe are properly installed.

**Note:** Make sure that all of the exhaust tubing is securely connected to reduce the chance of equipment exhaust entering the room.

An ion source produces both sample and solvent vapors. These vapors are a potential hazard to the laboratory environment. The source exhaust system is designed to safely remove and allow for the appropriate handling of the sample and solvent vapors. When the ion source is installed, the mass spectrometer does not operate unless the source exhaust system is operating.

## Ion Source Overview

---

A vacuum switch installed in the source exhaust sense circuit measures the vacuum in the source. If the vacuum in the source rises above the set point while the probe is installed, then the system enters an exhaust fault, that is, Not Ready, state.

An active exhaust system removes ion source exhaust, including gases, solvent, and sample vapor, through a drain port, without introducing chemical noise. The drain port connects through a drain chamber and a source exhaust pump to a drain bottle, and from there to a customer-supplied exhaust ventilation system. For information about the ventilation requirements for the source exhaust system, refer to the document: *Site Planning Guide*.

---

**Note:** Examine the source exhaust system periodically to make sure that the exhaust tubing is intact and that exhaust is not leaking in the room.

---

# Ion Source Installation

# 3



**WARNING! Electrical Shock Hazard.** Install the ion source on the mass spectrometer as the last step in this procedure. High voltage is present when the ion source is installed.

**CAUTION: Potential System Damage.** Do not lift or carry the ion source with one hand. The ion source is designed to be lifted or carried using two hands, one on each side of the ion source.

The ion source is connected to the vacuum interface and is held in position by two source latches. The interior of the ion source is visible through the windows on the side and front of the ion source.

When the ion source is installed, the software recognizes the ion source and shows the ion source identification.

## Required Materials

- Ion source
- TurbolonSpray probe
- (Optional) APCI probe
- Red PEEK tubing (0.005 inch bore)

## Prepare for Installation



**WARNING! Puncture Hazard.** Be careful when handling the electrode. The tip of the electrode is extremely sharp.

**Tip!** Do not discard the empty package. Use it to store the ion source when it is not in use.

Adjust the electrode adjustment nut on the probe to move the electrode tip inside the electrode tube. Refer to the figures: [Figure 2-2](#) and [Figure 2-3](#).

For optimum stability and performance, the electrode tip should extend between 0.5 mm and 1.0 mm from the end of the probe. Refer to the section: [Optimize the TurbolonSpray Probe Position](#) or [Optimize the APCI Probe Position](#).

## Install the Probe



**WARNING! Electrical Shock Hazard.** Make sure that the ion source is completely disconnected from the mass spectrometer before proceeding.

---



**WARNING! Puncture Hazard.** Be careful when handling the electrode. The tip of the electrode is extremely sharp.

---

**CAUTION: Potential System Damage.** Do not let the protruding electrode tip or the corona discharge needle touch any part of the ion source housing, to avoid damaging the probe.

---

**CAUTION: Potential System Damage.** Make sure that the corona discharge needle tip is turned away from the aperture if the TurbolonSpray probe is in use.

---

Prerequisite Procedures
<ul style="list-style-type: none"><li>• <a href="#">Remove the Ion Source.</a></li></ul>



The probe is not pre-installed in the ion source. Always remove the ion source from the mass spectrometer before exchanging probes.

---

**Note:** If the probe is not properly installed in the ion source, then the high-voltage power for the mass spectrometer and source exhaust system is turned off.

---

1. Make sure that the corona discharge needle tip is pointed away from the curtain plate aperture. Refer to the section: [Adjust the Position of the Corona Discharge Needle.](#)
2. Insert the probe in the tower. Align the hole on the probe with the corona discharge needle adjustment screw at the top of the ion source. Refer to the section: [Ion Source Components.](#)
3. Gently push the probe down until the contacts engage with those in the tower.
4. Turn the retaining ring over the probe, push it down to engage the threads on the probe with the threads on the tower, and then tighten it until it is finger-tight.
5. For the APCI probe only, make sure that the corona discharge needle tip is pointed toward the curtain plate aperture. Refer to the section: [Adjust the Position of the Corona Discharge Needle.](#)

## Connect the Ion Source Tubing



**WARNING! Electrical Shock Hazard.** Do not bypass the grounding union connection. The grounding union provides grounding between the mass spectrometer and the sample introduction device.

---



**WARNING! Ionizing Radiation Hazard, Biohazard, or Toxic Chemical Hazard.** Make sure that the sample tubing nut is tightened properly before operating this equipment, to prevent leakage.

---

Refer to the section: [Ion Source Components](#).

1. Insert a 30 cm piece of red PEEK tubing in the sample tubing nut.
2. Install the sample tubing nut in the port at the top of the probe, and then tighten the sample tubing nut until it is finger-tight.
3. Connect the other end of the tubing to the grounding union on the ion source.

## Install the Ion Source on the Mass Spectrometer



**WARNING! Electrical Shock Hazard.** Install the probe in the ion source before installing the ion source on the mass spectrometer.

---



**WARNING! Pinching Hazard.** When installing the ion source, be careful not to pinch fingers between the ion source and the vacuum interface.

---

**CAUTION: Potential System Damage.** Do not let the protruding electrode tip or the corona discharge needle touch any part of the ion source housing, to avoid damaging the probe.

---

**Note:** If the probe is not properly installed in the ion source, then the high-voltage power for the mass spectrometer and source exhaust system is turned off.

---

## Ion Source Installation

---

### Prerequisites

- Make sure that all of the O-rings are present on the vacuum interface.

**Figure 3-1 O-rings on the Vacuum Interface**

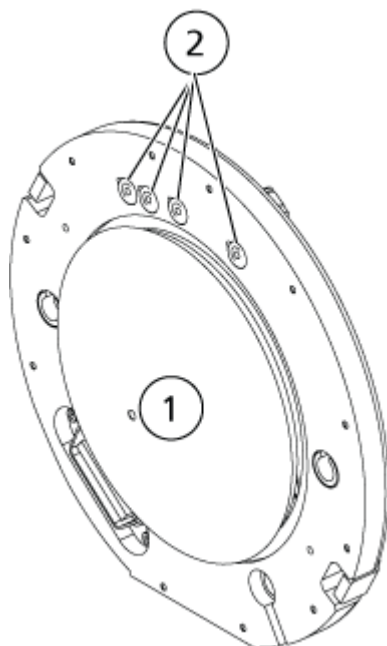

Item	Description
1	Curtain plate
2	O-rings

1. Make sure that the ion source latches on either side of the ion source are pointing up in the 12 o'clock position. Refer to the section: [Ion Source Components](#).
2. Align the ion source with the vacuum interface, making sure that the guide pins on the ion source are aligned with the sockets in the vacuum interface.
3. Push the ion source gently against the vacuum interface and then rotate the ion source latches down to lock the ion source in place.  
The mass spectrometer recognizes the ion source and then shows the ion source identification in the control software.
4. Connect the red PEEK tubing from the sample supply device to the other side of the grounding union on the ion source.

## Sample Inlet Requirements

- Use appropriate analytical procedures and practices to minimize external dead volumes. The sample inlet transfers the liquid sample to the ion source inlet without loss and with minimal dead volume.
- Prefilter samples so that the capillary tubing in the sample inlets is not blocked by particles, precipitated samples, or salts.
- Make sure that all of the connections are tight enough to prevent leaks. Do not over-tighten.

## Inspect for Leaks



---

**WARNING! Toxic Chemical Hazard. Wear personal protective equipment, including a laboratory coat, gloves, and safety glasses, to avoid skin or eye exposure.**

---

Inspect fittings and tubing to make sure that there are no leaks.



---

**WARNING! Ionizing Radiation Hazard, Biohazard, or Toxic Chemical Hazard. Do not use the ion source without knowledge of and training in the proper use, containment, and evacuation of toxic or injurious materials used with the ion source.**

---



---

**WARNING! Fire Hazard. Do not direct more than 3 mL/min of flammable solvent in the ion source. Exceeding the maximum flow rate can cause solvent to accumulate in the ion source. Do not use the ion source if the source exhaust system is not enabled and functioning when the ion source and the probe are properly installed.**

---



---

**WARNING! Puncture Hazard, Ionizing Radiation Hazard, Biohazard, or Toxic Chemical Hazard. Discontinue use of the ion source if the ion source window is cracked or broken, and then contact a SCIEX Field Service Employee (FSE). Any toxic or injurious materials introduced in the equipment will be present in the source exhaust output. Exhaust from equipment should be vented from the room. Dispose of sharps following established laboratory safety procedures.**

---

Optimize the ion source whenever the analyte, flow rate, or mobile phase composition changes.

When optimizing ion source-dependent parameters, introduce the sample at a flow rate that will be used during sample analysis, using either flow injection analysis (FIA) or tee infusion as the method of sample introduction. Optimize the position of the ion source before optimizing the ion source-dependent parameters.

Several parameters affect the performance of the source. Optimize the performance while injecting a known compound and monitoring the signal of the known ion. Adjust the micrometer and gas and voltage parameters to maximize the signal-to-noise ratio and signal stability.

Refer to the section: [TurbolonSpray Probe Optimization](#) or [APCI Probe Optimization](#).

## Sample Introduction

### Method

The liquid sample stream is delivered to the ion source by an LC pump or by a syringe pump. If it is delivered by an LC pump, then the sample can be injected directly in the mobile phase using flow injection analysis (FIA) or tee infusion, through a syringe pump, or through a separation column using a loop injector or autosampler. If it is introduced by a syringe pump, then the



sample is injected directly in the ion source. Infusion optimization can only be used for ion path optimization and MS/MS fragment selection.

The liquid sample stream is delivered to the ion source by an LC pump. The sample can be injected directly in the mobile phase using flow injection analysis (FIA) or tee infusion, through a syringe pump (not supplied), or through a separation column using a loop injector or autosampler.

### Flow Rate

Sample flow rates are determined by the LC system or syringe pump. The TurbolonSpray probe supports flow rates from 5  $\mu\text{L}/\text{min}$  to 3,000  $\mu\text{L}/\text{min}$ . The APCI probe supports flow rates from 200  $\mu\text{L}/\text{min}$  to 3,000  $\mu\text{L}/\text{min}$ .

## TurbolonSpray Probe Optimization



---

**WARNING! Ionizing Radiation Hazard, Biohazard, or Toxic Chemical Hazard. Make sure that the source exhaust system is connected and functioning, and that good general laboratory ventilation is provided. Adequate laboratory ventilation is required to control solvent and sample emissions, and to provide for the safe operation of the system.**

---



---

**WARNING! Fire Hazard. Do not direct more than 3 mL/min of flammable solvent in the ion source. Exceeding the maximum flow rate can cause solvent to accumulate in the ion source. Do not use the ion source if the source exhaust system is not enabled and functioning when the ion source and the probe are properly installed.**

---



---

**WARNING! Ionizing Radiation Hazard, Biohazard, or Toxic Chemical Hazard. Make sure that the electrode protrudes beyond the tip of the probe, to prevent hazardous vapors from escaping from the source. The electrode must not be recessed within the probe.**

---

---

**CAUTION: Potential System Damage. If the LC system connected to the mass spectrometer is not controlled by the software, then do not leave the mass spectrometer unattended while in operation. The liquid stream from the LC system can flood the ion source when the mass spectrometer goes in Standby state.**

---

**Note:** To keep the system clean and at optimum performance, adjust the probe position when changing the flow rate.

---

**Tip!** It is easier to optimize signal and signal-to-noise with flow injection analysis than with on-column injections.

---

## Ion Source Optimization

---

**Note:** If the ion source voltage is too high, then a corona discharge can occur. In the Analyst software, this is the **IonSpray Voltage** field. In the Analyst TF software, this is the **IonSpray Voltage Floating** field. In SCIEX OS, this is the **Spray voltage** field. A corona discharge is visible as a blue glow at the tip of the probe. It results in decreased sensitivity and stability of the signal.

---

## Flow Rate and Ion Source Temperature

The sample introduction flow rate and the sample solvent composition affect the optimal TurbolonSpray probe temperature. A higher flow rate or a higher aqueous content requires a higher optimal temperature.

The TurbolonSpray probe is often used with sample flow rates of 5  $\mu\text{L}/\text{min}$  to 1,000  $\mu\text{L}/\text{min}$ . The heat is used to increase the rate of evaporation which improves ionization efficiency, resulting in increased sensitivity. Extremely low flow rates of high organic solvent usually do not require increased temperatures. Refer to the section: [Source Parameters and Voltages](#).

## Set Up the System for Tee Infusion

---

**Note:** This process uses triazine infusion as an example. To optimize a different compound, use that compound in the optimization process.

---

**Note:** This process is for both Analyst software and SCIEX OS. For more specific instructions on optimization, refer to the section: [Set Up the System](#).

---

1. Make sure that an analytical column is not installed in the LC system.
2. Connect the autosampler outlet tubing to a union, and connect another piece of tubing to the other end of the union. Connect this tubing to the Tee piece.
3. Connect the output of the Tee to the mass spectrometer grounding union using PEEK tubing.
4. Connect the needle to the 1 mL syringe.
5. Fill the syringe with the appropriate volume of triazine infusion dilution. Refer to the document: *Customer Familiarization Checklist*.  
Make sure that air bubbles are removed from the syringe.
6. Remove the needle and connect the syringe to the infusion PEEK tubing line.
7. Install the syringe in the syringe pump, and then connect the infusion line to the Tee piece.

Figure 4-1 Tee Infusion Setup



Item	Description
1	Syringe filled with the compound solution sits in the MS integrated syringe pump
2	Mobile phase through LC pump outlet
3	To mass spectrometer inlet

## Optimize the TurbolonSpray Probe Position



**WARNING! Ionizing Radiation Hazard, Biohazard, or Toxic Chemical Hazard.** Make sure that the electrode protrudes beyond the tip of the probe, to prevent hazardous vapors from escaping from the source. The electrode must not be recessed within the probe.



**WARNING! Puncture Hazard.** Be careful when handling the electrode. The tip of the electrode is extremely sharp.

## Ion Source Optimization

---

After the probe is optimized, it needs only minor adjustment. If the probe is removed, or if the analyte, flow rate, or solvent composition change, then repeat the optimizing procedure.

Refer to the section: [Ion Source Components](#).

1. Look through the window of the ion source to view the position of the probe.
2. Use the previous horizontal and vertical micrometer settings or set them to **5** as a starting position.
3. Monitor the signal or signal-to-noise of the analytes in the control software.
4. Use the horizontal micrometer to adjust the probe position in small increments to achieve the best signal or signal-to-noise ratio.

The probe can optimize slightly to either side of the aperture.

---

**Tip!** Adjust the horizontal micrometer setting to direct the liquid spray from the TurbolonSpray probe away from the aperture to prevent contamination of the aperture; to prevent piercing of the flow of the gas for the Curtain Gas interface, which can create an unstable signal; and to prevent electrical shorting due to the presence of the liquid.

---

5. Use the vertical micrometer to adjust the probe position in small increments to achieve the best signal or signal-to-noise ratio.

---

**Note:** The vertical position of the probe depends on the flow rate. At lower flow rates, the probe should be closer to the aperture. At higher flow rates, the probe should be farther from the aperture.

---

6. Adjust the black electrode adjustment nut on the probe to move the electrode tube in or out of the probe (to adjust the protrusion).

---

**Note:** The electrode tip should protrude between 0.5 mm and 1.0 mm from the end of the probe.

---

The optimal setting for the electrode tip is compound-dependent. The distance that the electrode tip protrudes affects the shape of the spray cone, and the shape of the spray cone affects mass spectrometer sensitivity.

**Figure 4-2 Electrode Tip Extension Adjustment**

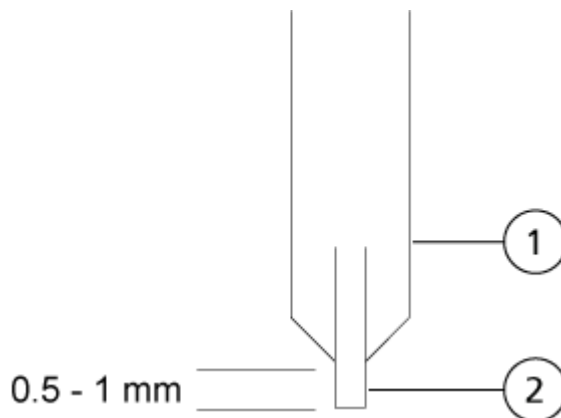

Item	Description
1	Probe
2	Electrode

## Optimize Source and Gas Parameters and Voltage

Optimize ion source gas 1 (nebulizer gas) for the best signal stability and sensitivity. Ion source gas 2 (heater gas) aids in the evaporation of solvent, which helps to increase the ionization of the sample.

Too high a temperature can cause premature vaporization of the solvent at the tip of the TurbolonSpray probe, especially if the probe protrudes too far, which results in signal instability and a high chemical background noise. Similarly, a high heater gas flow can produce a noisy or unstable signal.

Use the lowest ion source voltage possible without losing signal.

**Note:** If the ion source voltage is too high, then a corona discharge can occur. In the Analyst software, this is the **IonSpray Voltage** field. In the Analyst TF software, this is the **IonSpray Voltage Floating** field. In SCIEX OS, this is the **Spray voltage** field. A corona discharge is visible as a blue glow at the tip of the probe. It results in decreased sensitivity and stability of the signal.

1. Adjust ion source gas 1 and ion source gas 2 in increments of 5 to achieve the best signal or signal-to-noise ratio.
2. Increase the flow rate of the gas for the Curtain Gas interface until the signal begins to decrease.

## Ion Source Optimization

---

**Note:** To prevent contamination, use the highest possible value for the flow rate of the gas for the Curtain Gas interface that does not sacrifice sensitivity. Do not set the flow rate lower than the values in the table: [Table 4-1](#). This helps to prevent penetration of the flow of the gas for the Curtain Gas interface, which can produce a noisy signal; prevent contamination of the aperture; and increase the overall signal-to-noise ratio.

**Table 4-1 CUR Parameter Values**

Mass Spectrometer	Starting Value
SCIEX 3500, 4000, and 4500 systems	20
SCIEX 5000, 5500, and 5500+ systems	25
SCIEX 6500 and 6500+ systems	30
TripleTOF 5600, 5600+, 6600, and 6600+ systems	20 to 25, depending on the flow rate

---

3. Adjust the ion source voltage in increments of 500 V to maximize signal-to-noise.

## Source Optimization Procedures (SCIEX OS)

Prerequisites
<ul style="list-style-type: none"><li>• Set up the Tee infusion tubing, connector, mass spectrometer, and LC pump. Refer to the section: <a href="#">Set Up the System for Tee Infusion</a></li><li>• Create a new LC Method using the appropriate values for the optimization. Refer to the document: <i>Software User Guide</i>.</li><li>• Create a new MRM Method using the appropriate values for the optimization. Refer to the document: <i>Software User Guide</i>.</li></ul>

1. In the Configuration Workspace on the Queue page, type an **Instrument idle time** between 30 to 60 minutes.
2. On the status panel, click **Direct Device Control** for the syringe and type the appropriate values.

Figure 4-3 Syringe Device Control dialog

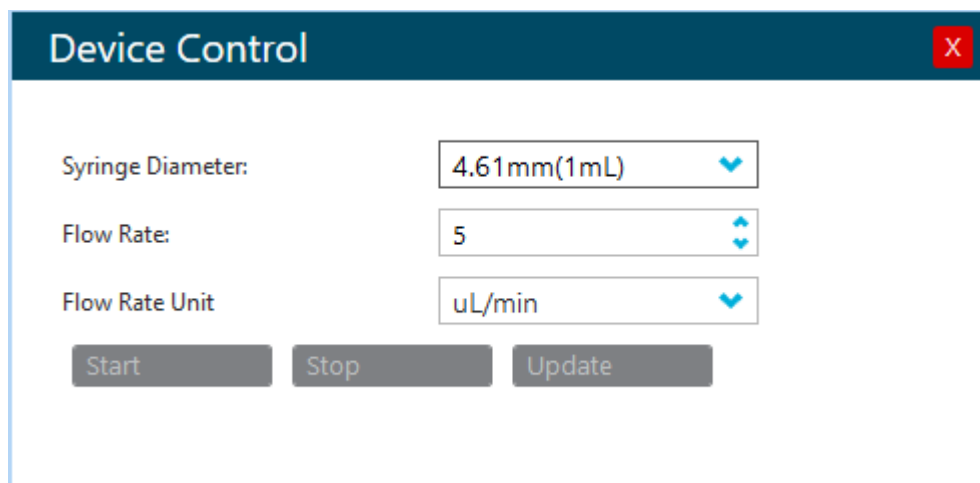

3. Click **Equilibrate** and then set the equilibration time, MS methods, and LC methods.

---

**Note:** Choose an equilibration time that allows the instrument to reach the set points in the selected MS and LC methods.

---

4. Click **Start**.  
Make sure that the syringe is moving freely and that there are no leaks.
5. Click **Start** to begin data collection when the instrument state is *Ready*.
6. Optimize source and gas parameters after a stable MRM baseline is acquired in the XIC section of the Data Acquisition panel.  
Needle protrusion and needle position can be changed after the source and gas parameters have been optimized. Adjustment results can be seen on the Data Acquisition panel.
7. To test source conditions and other gradient compositions, click **Device Direct Control** beside the LC system in the status panel.  
The Device Control dialog opens.
8. Adjust the **Flow** and **Concentration** parameters and click **OK**.
9. Click **Stop** on the Data Acquisition pane and **Save** the data file.
10. From the MS Method window, **Save** the optimized source and gas parameters.

---

**Tip!** The optimized parameters are usually applicable to a wide range of compounds. For more complex mixtures, certain compounds can require a different source temperature or **Spray voltage**.

---

11. After optimization is complete, click **Stop** on the syring Device Control dialog and set the system to Standby.

## Ion Source Optimization

---

The MS method and LC flow stops. The source and gas parameters stay active.

### Optimize the Turbo Heater Temperature

The optimal heater temperature is dependent on the compound, flow rate, and mobile phase composition. The higher the flow rate and the higher the aqueous composition, the higher the optimized temperature.

When optimizing the source temperature, make sure that the ion source equilibrates to the new temperature setting.

Adjust the ion source temperature in increments of 50 °C to 100 °C to achieve the best signal or signal-to-noise ratio.

### Optimization Tips

Optimization of the ion source minimizes the need for cleaning of the ion source and vacuum interface components.

- Use the highest ion source temperature possible when optimizing compounds. A temperature of 700 °C is common for many compounds. High temperatures help keep the ion source clean and reduce background noise.
- Use the highest possible value for the flow rate of the gas for the Curtain Gas interface that does not sacrifice sensitivity. This helps to:
  - Prevent penetration of the flow of gas for the Curtain Gas interface, which can produce a noisy signal.
  - Prevent contamination of the aperture.
  - Increase the overall signal-to-noise ratio.
- Adjust the horizontal micrometer setting to direct the liquid spray from the probe away from the aperture to:
  - Prevent contamination of the aperture.
  - Prevent piercing of the flow of gas for the Curtain Gas interface, which can create an unstable signal.
  - Prevent electrical shorting due to the presence of the liquid.

To do so, use the vertical micrometer to move the probe up.

- Use the lowest ion source voltage possible without losing signal. In the Analyst software, this is the **IonSpray Voltage** field. In the Analyst TF software, this is the **IonSpray Voltage Floating** field. In SCIEX OS, this is the **Spray Voltage** field. Focus on signal-to-noise and not just signal.



- For flow rates greater than 2 mL/min in APCI mode, equilibrate the mass spectrometer before starting the liquid flow, to make sure that the nebulization temperature is reached.

# Ion Source Maintenance

# 5

The following warnings apply to all of the maintenance procedures in this section.



**WARNING! Hot Surface Hazard.** Let the Turbo V ion source cool for at least 30 minutes before starting any maintenance procedures. Some surfaces of the ion source and vacuum interface become hot during operation.



**WARNING! Fire and Toxic Chemical Hazard.** Keep flammable liquids away from flame and sparks and use them only in vented chemical fume hoods or safety cabinets.



**WARNING! Toxic Chemical Hazard.** Wear personal protective equipment, including a laboratory coat, gloves, and safety glasses, to avoid skin or eye exposure.



**WARNING! Ionizing Radiation Hazard, Biohazard, or Toxic Chemical Hazard.** In the event of a chemical spill, review product safety data sheets for specific instructions. Make sure that the system is in Standby state before cleaning a spill near the ion source. Use appropriate personal protective equipment and absorbent wipes to contain the spill and dispose of it following local regulations.



**WARNING! Electrical Shock Hazard.** Avoid contact with the high voltages applied to the ion source during operation. Put the system in Standby state before adjusting the sample tubing or other equipment near the ion source.



**WARNING! Puncture Hazard, Ionizing Radiation Hazard, Biohazard, or Toxic Chemical Hazard.** Discontinue use of the ion source if the ion source window is cracked or broken, and then contact a SCIEX Field Service Employee (FSE). Any toxic or injurious materials introduced in the equipment will be present in the source exhaust output. Exhaust from equipment should be vented from the room. Dispose of sharps following established laboratory safety procedures.

**CAUTION: Potential System Damage.** Do not lift or carry the ion source with one hand. The ion source is designed to be lifted or carried using two hands, one on each side of the ion source.

This section contains general maintenance procedures for the ion source. To determine how often to clean or perform maintenance on the ion source, consider the following:

- Compounds tested
- Cleanliness of the samples and sample preparation techniques
- Amount of time an idle probe contains a sample
- Overall system run time

These factors can cause changes in ion source performance, indicating that maintenance is required.

Make sure that the installed ion source is fully sealed to the mass spectrometer with no evidence of gas leaks. Regularly inspect the ion source and its fittings for leaks. Clean the ion source components regularly to keep the ion source in good working condition.

---

**CAUTION: Potential System Damage. Use only the recommended cleaning methods and materials to avoid damaging the equipment.**

---

### Required Materials

- 1/4 inch open-ended wrench
- Flat-bladed screwdriver
- LC-MS-grade methanol
- LC-MS-grade deionized water
- Safety glasses
- Breathing mask and filter
- Powder-free gloves, nitrile or neoprene recommended
- Lab coat

## Recommended Maintenance Schedule

The following table provides a recommended schedule for cleaning and maintaining the ion source. For a list of consumable and spare parts, refer to the document: *Parts and Equipment Guide*.

---

**Tip!** Perform maintenance tasks regularly to make sure that the system is performing optimally.

---

Contact a Qualified Maintenance Person (QMP) to order consumable parts and for basic service and maintenance requirements. Contact a SCIEX Field Service Employee (FSE) for all other service and maintenance requirements.

---

**Note:** For part numbers, refer to the document: *Parts and Equipment Guide*.

---

## Ion Source Maintenance

---

**Table 5-1 Ion Source Maintenance Tasks**

Component	Frequency	Task	For More Information
TurbolonSpray and APCI probes	As needed	Examine and replace	Refer to the section: <a href="#">Remove the Probe</a> and <a href="#">Install the Probe</a> .
Electrodes for the TurbolonSpray and APCI probes	As needed	Examine and replace	Refer to the section: <a href="#">Replace the Electrode</a> .
Corona discharge needle	As needed	Replace	Refer to the section: <a href="#">Replace the Corona Discharge Needle</a> .
Turbo heater	As needed	Replace	Contact the local QMP or FSE.
Sample tubing	As needed	Replace	Refer to the section: <a href="#">Connect the Ion Source Tubing</a> .

## Ion Source Handling

Surfaces of the ion source become hot during operation. The following figure shows surfaces that are cooler (blue and gray) and surfaces that remain hot for an extended period of time (red). Do not touch the surfaces shown in red while using or removing the ion source.

Figure 5-1 Ion Source Hot Surfaces (Red=Hot, Gray=Warm, Blue=Handle with Care)

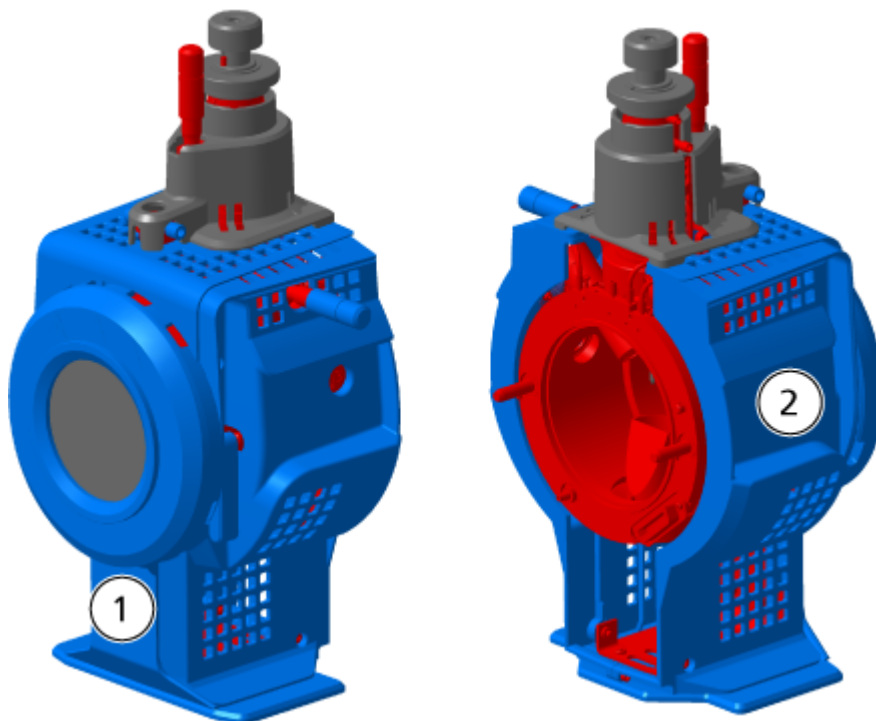

Item	Description
1	Front
2	Back

## Remove the Ion Source

**Note:** (SCIEX 3500, 4500, 5500, 5500+, 6500, 6500+, and TripleTOF systems) Nitrogen continues to flow at a rate of 5.3 L/min when the mass spectrometer is off or when the ion source is removed from the system. To minimize nitrogen gas consumption and to keep the mass spectrometer clean when it is not in use, leave the ion source installed on the mass spectrometer and leave the system on.

The ion source can be removed quickly and easily, without tools. Always remove the ion source from the mass spectrometer before performing any maintenance on the ion source or exchanging the probes.

1. Stop any ongoing scans.
2. Turn off the sample stream.
3. Set the ion source **Temperature** to 0, if the heaters are in use.

## Ion Source Maintenance

---

4. (SCIEX OS) Click **Standby** (  ) on the status panel.
5. Wait at least 30 minutes for the ion source to cool.
6. Disconnect the sample tubing from the grounding union.
7. Turn the two source latches up to the 12 o'clock position to release the ion source.
8. Pull the ion source gently away from the vacuum interface.

---

**Note:** Be careful not to lose the O-rings that are installed on the vacuum interface.

---

9. Put the ion source on a clean, secure surface.

## Clean the Ion Source Surfaces



**WARNING! Electrical Shock Hazard. Remove the ion source from the mass spectrometer before starting this procedure. Follow all electrical safe work practices.**

---

<b>Prerequisite Procedures</b>
--------------------------------

- [Remove the Ion Source.](#)

Clean the surfaces of the ion source after a spill or when they become dirty.

Wipe the surfaces of the ion source with a soft, damp, cloth.

## Clean the Probe

Flush the ion source periodically, regardless of the type of compounds sampled. Do this by setting up a method in the control software specifically for performing a flushing operation.

1. Change to a mobile phase that is 1:1 water:acetonitrile or 1:1 water:methanol.
2. Adjust the position of the probe so that it is as far from the orifice as possible.
3. In the control software, do the following:
  - a. Create an MS method.
  - b. Set the ion source temperature between 500 °C and 600 °C.
  - c. Set ion source gas 1 and ion source gas 2 to at least 40.
  - d. Set the flow rate of the gas for the Curtain Gas interface to the highest setting possible.

4. Wait until the temperature setpoint is reached.
5. Make sure that the probe and sample tubing are flushed thoroughly.

## Remove the Probe



**WARNING! Electrical Shock Hazard.** Remove the ion source from the mass spectrometer before starting this procedure. Follow all electrical safe work practices.

**CAUTION: Potential System Damage.** Do not let the protruding electrode tip or the corona discharge needle touch any part of the ion source housing, to avoid damaging the probe.

### Prerequisite Procedures

- [Remove the Ion Source.](#)

The probe can be removed quickly and easily, without tools. Always remove the ion source from the mass spectrometer before changing probes or performing maintenance on the probe.

1. Loosen the sample tubing nut and then disconnect the sample tubing from the probe.
2. Loosen the retaining ring that secures the probe on the ion source housing.
3. Gently pull the probe straight up out of the tower.
4. Put the probe on a secure, clean surface.

## Replace the Electrode



**WARNING! Electrical Shock Hazard.** Remove the ion source from the mass spectrometer before starting this procedure. Follow all electrical safe work practices.



**WARNING! Puncture Hazard.** Be careful when handling the electrode. The tip of the electrode is extremely sharp.

### Prerequisite Procedures

- [Remove the Ion Source.](#)
- [Remove the Probe.](#)

## Ion Source Maintenance

---

The probe contains an electrode. Replace the electrode when there is a decrease in performance.

**Note:** After replacing the electrode, evaluate the effect of the change on system performance.

---

This procedure applies to both probes.

1. Remove the electrode adjustment nut and then remove the electrode.
2. Holding the probe with the tip pointing down, so that the spring remains inside the probe, install a sample fitting in the PEEK union, tightening until it is finger-tight.

**Figure 5-2 Probe, Expanded View**

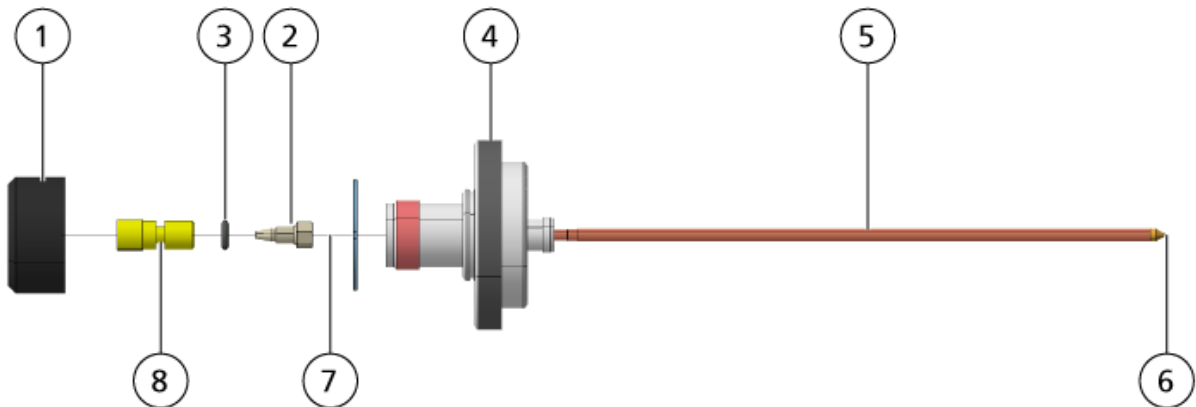

Item	Description
1	Electrode adjustment nut
2	1/4 inch retaining nut
3	Spring
4	Retaining ring
5	Sprayer tube
6	Electrode tip
7	Electrode tube
8	PEEK union

3. Pull the PEEK union and the attached electrode tube from the probe.
4. Remove the sample fitting from the PEEK union.



5. Use the 1/4 inch open-ended wrench to remove the retaining nut that holds the electrode tube in the PEEK union.
6. Remove the electrode tube from the retaining nut.
7. Insert the new electrode tube in the retaining nut and then in the PEEK union.  
Make sure that the electrode tube is inserted as far as possible in the PEEK union. If there is a gap between the electrode tube and its seat inside the union, a dead volume may occur.
8. Tighten the retaining nut.  
Do not cross-thread or over-tighten the retaining nut or the tubing might leak.
9. Make sure that the spring is still inside the probe and then tighten the electrode adjustment nut.
10. Align the electrode tube with the narrow opening in the sprayer tube and then insert the PEEK union and attached electrode tube in the probe. Be careful not to bend the electrode tube.
11. Install and then tighten the electrode adjustment nut.
12. Install the probe. Refer to the section: [Install the Probe](#).
13. Install the ion source on the mass spectrometer. Refer to the section: [Ion Source Installation](#).
14. Connect the sample tubing. Refer to the section: [Connect the Ion Source Tubing](#).
15. Adjust the electrode tip extension. Refer to the section: [Optimize the TurbolonSpray Probe Position](#) or [Optimize the APCI Probe Position](#).

## Replace the Corona Discharge Needle



---

**WARNING! Electrical Shock Hazard.** Remove the ion source from the mass spectrometer before starting this procedure. Follow all electrical safe work practices.

---



---

**WARNING! Puncture Hazard.** Handle the needle with care. The tip of the needle is extremely sharp.

---

Prerequisite Procedures
<ul style="list-style-type: none"><li>• <a href="#">Remove the Ion Source</a>.</li><li>• <a href="#">Remove the Probe</a>.</li></ul>

## Ion Source Maintenance

---

If the corona discharge needle tip becomes corroded, then it might not be removable by hand. If it cannot be removed, then cut off the needle tip to remove it and replace the entire corona discharge needle.

1. Rotate the ion source so that the open side is accessible.

**Figure 5-3 Corona Discharge Needle**

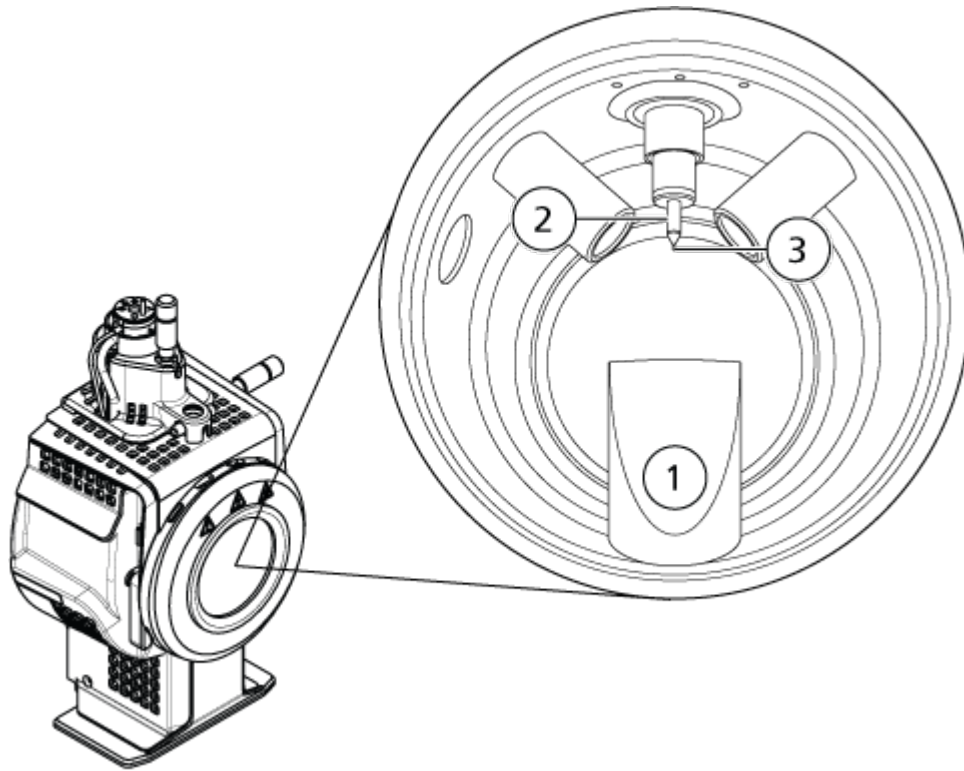

Item	Description
1	Exhaust chimney
2	Ceramic sleeve
3	Corona discharge needle tip

2. While holding the corona discharge needle adjustment screw between the thumb and forefinger of one hand and the corona discharge needle with the other hand, rotate the corona discharge needle tip counter-clockwise to loosen and then gently remove the tip. Refer to the section: [Ion Source Components](#).
3. Gently pull the corona discharge needle down through the exhaust chimney to remove it.

4. Insert the new needle through the exhaust chimney in the ceramic sleeve as far as possible.
5. Holding a new tip between the thumb and forefinger of one hand and the corona discharge needle adjustment screw with the other hand, rotate the corona discharge needle tip clockwise to install the tip.
6. Insert the probe and then install the ion source on the mass spectrometer. Refer to the section: [Ion Source Installation](#).

## Replace the Sample Tubing



**WARNING! Electrical Shock Hazard. Remove the ion source from the mass spectrometer before starting this procedure. Follow all electrical safe work practices.**

---

### Prerequisite Procedures

- Stop the sample flow and make sure that any remaining gas has been removed through the source exhaust system.
- Remove the ion source. Refer to the section: [Remove the Ion Source](#).

Use the following procedure to replace the sample tubing if it has a blockage.

1. Disconnect the sample tubing from the probe and the grounding union.
2. Replace the sample tubing with an appropriate length of tubing, cut with a proper tubing cutter. Refer to the section: [Connect the Ion Source Tubing](#).
3. Install the ion source. Refer to the section: [Ion Source Installation](#).
4. Start the sample flow.

## Storage and Handling



**WARNING! Environmental Hazard. Do not dispose of system components in municipal waste. Follow local regulations when disposing of components.**

---

The environmental requirements for the storage and transport of the ion source:

- Ambient temperature between  $-30\text{ }^{\circ}\text{C}$  and  $+60\text{ }^{\circ}\text{C}$  ( $-22\text{ }^{\circ}\text{F}$  and  $140\text{ }^{\circ}\text{F}$ )
- Atmospheric pressure between 75 kPa to 101 kPa
- Relative humidity not exceeding 99%, non-condensing

# Ion Source Troubleshooting

# 6

Symptom	Possible Cause	Corrective Action
The control software reports that the mass spectrometer has gone to a Fault state.	<ol style="list-style-type: none"><li>1. The probe is not installed.</li><li>2. The probe is not connected securely.</li></ol>	<ol style="list-style-type: none"><li>1. Install the probe. Refer to the section: <a href="#">Install the Probe</a>.</li><li>2. Reinstall the probe:<ol style="list-style-type: none"><li>a. Remove the probe. Refer to the section: <a href="#">Remove the Probe</a>.</li><li>b. Install the probe, making sure to tighten the retaining ring securely. Refer to the section: <a href="#">Install the Probe</a>.</li></ol></li></ol>
The control software indicates that a specific probe is in use, but a different probe is installed.	The F3 fuse is blown.	Contact an FSE.
The spray is not uniform.	The electrode is blocked.	Replace the electrode. Refer to the section: <a href="#">Replace the Electrode</a> .
The ion source temperature is not reached or temperature is too high or unstable.	The turbo heater is faulty.	Contact the local QMP or FSE.
Sensitivity is poor.	<ol style="list-style-type: none"><li>1. The interface components (front end) are dirty.</li><li>2. Solvent vapor or other unknown compounds are present in the analyzer region.</li></ol>	<ol style="list-style-type: none"><li>1. Clean the interface components and then install the ion source.</li><li>2. Optimize the flow rate of the gas for the Curtain Gas interface. Refer to the section: <a href="#">Ion Source Optimization</a>.</li></ol>

<b>Symptom</b>	<b>Possible Cause</b>	<b>Corrective Action</b>
During testing, the ion source fails to meet specifications.	<ol style="list-style-type: none"><li>1. The test solution was not prepared correctly.</li><li>2. The mass spectrometer has not passed the installation tests.</li></ol>	<ol style="list-style-type: none"><li>1. Confirm that the test solution was prepared correctly.</li><li>2. If the problem cannot be resolved, then contact the FSE to perform the installation tests.</li></ol>

## Ion Source Troubleshooting

---

Symptom	Possible Cause	Corrective Action
Background noise is high.	<ol style="list-style-type: none"><li>1. The ion source temperature is too high.</li><li>2. The heater gas (ion source gas 2) flow rate is too high.</li><li>3. The ion source is contaminated.</li></ol>	<ol style="list-style-type: none"><li>1. Optimize the ion source temperature.</li><li>2. Optimize the heater gas flow.</li><li>3. Clean or replace the ion source components, and then condition the ion source and front end:<ol style="list-style-type: none"><li>a. Move the probe to the furthest position from the aperture (vertically and horizontally).</li><li>b. Make sure that the interface heater is on.</li><li>c. Infuse or inject 50:50 methanol:water with a pump flow rate of 1 mL/min.</li><li>d. In the control software, set the ion source temperature to 650, ion source gas 1 to 60, and ion source gas 2 to 60.</li><li>e. Set the flow rate of the gas for the Curtain Gas interface to 45 or 50.</li><li>f. Acquire data for a minimum of 2 hours, or preferably overnight, for best results.</li></ol></li></ol>

Symptom	Possible Cause	Corrective Action
<p>Ion source performance has degraded.</p>	<ol style="list-style-type: none"> <li>1. The probe is not optimized.</li> <li>2. The sample was not prepared correctly or the sample has degraded.</li> <li>3. The sample inlet fittings are leaking.</li> </ol>	<ol style="list-style-type: none"> <li>1. Optimize the probe. Refer to the section: <a href="#">TurbolonSpray Probe Optimization</a> or <a href="#">APCI Probe Optimization</a>.</li> <li>2. Make sure that the sample was prepared correctly.</li> <li>3. Make sure that the fittings are tight and replace the fittings if leaks continue. Do not overtighten the fittings.</li> <li>4. Install and optimize an alternate ion source. If the issue persists, then contact an FSE</li> </ol>
<p>Arcing or sparks occur.</p>	<p>The position of the corona discharge needle is incorrect or the electrode tip is damaged.</p>	<p>Turn the corona discharge needle toward the curtain plate, and away from the stream of heater gas. Refer to the section: <a href="#">Adjust the Position of the Corona Discharge Needle</a>.</p>

# Principles of Operation — Ion Source

---

# A

## Electrospray Ionization Mode

The probe is located centrally between the two turbo heaters, which are located at a 45-degree angle on either side of the probe. The combination of the spray and the heated dry gas from the turbo heaters is projected at a 90-degree angle to the aperture in the curtain plate.

Only compounds that ionize in the liquid solvent can be generated as gas phase ions in the source. The efficiency and rate of ion generation depends on the solvation energies of the specific ions. Ions with lower solvation energies are more likely to evaporate than ions with higher solvation energies.

The interaction of the **IonSpray Voltage** (Analyst software), **IonSpray Voltage Floating** (Analyst TF software), or the **Spray voltage** (SCIEX OS) and the turbo heaters helps focus the stream and increases the rate of droplet evaporation, resulting in an increased ion signal. The heated gas increases the efficiency of ion evaporation, resulting in increased sensitivity and the ability to handle higher liquid sample flow rates.

A high-velocity flow of nebulizer gas shears droplets from the liquid sample stream in the **IonSpray Voltage**, **IonSpray Voltage Floating**, or **Spray voltage** inlet. Using the variable high voltage applied to the sprayer, the ion source applies a net charge to each droplet. This charge aids in the droplet dispersion. Ions of a single polarity are preferentially drawn in the droplets by the high voltage as they are separated from the liquid stream. However, this separation is incomplete and each droplet contains many ions of both polarities. Ions of one polarity are predominant in each droplet, and the difference between the number of positively or negatively charged ions results in the net charge. Only the excess ions of the predominant polarity are available for ion evaporation, and only a fraction of these actually evaporate.

The probe can generate multiply-charged ions from compounds that have multiple charge sites, such as peptides and oligonucleotides. This is useful during analysis of high-molecular-weight species where the multiple charges produce ions of a mass-to-charge ratio ( $m/z$ ) within the mass range of the mass spectrometer. This allows routine molecular-weight determinations of compounds in the kiloDalton (kDa) range.

Each charged droplet contains solvent and both positive and negative ions, but with ions of one predominant polarity. Refer to the figure: [Figure A-1](#). As a conducting medium, excess charges reside at the surface of the droplet. As the solvent evaporates, the electrical field at the surface of the droplet increases due to the decreasing radius of the droplet.



Figure A-1 Ion Evaporation

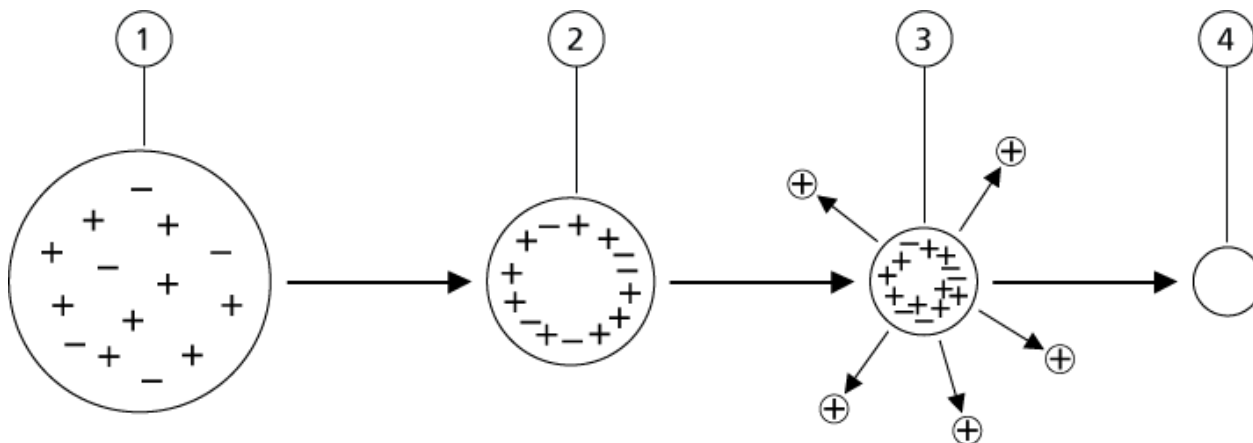

Item	Description
1	Droplet contains ions of both polarities with one polarity being predominant.
2	As the solvent evaporates, the electrical field increases and the ions move to the surface.
3	At some critical field value, ions are emitted from the droplets.
4	Nonvolatile residue remains as a dry particle.

If the droplet contains excess ions and enough solvent evaporates from the droplet, a critical field is reached at which ions are emitted from the surface. Eventually, all of the solvent will evaporate from the droplet, leaving a dry particle consisting of the nonvolatile components of the sample solution.

Because the solvation energies for most organic molecules are unknown, the sensitivities of any given organic ion to ion evaporation are difficult to predict. The importance of solvation energy is evident because surfactants that concentrate at the surface of a liquid can be detected very sensitively.

## APCI Mode

The basis for past incompatibilities in linking liquid chromatography with mass spectrometry arose from difficulties converting relatively nonvolatile molecules in solution in a liquid into a molecular gas without inducing excessive decomposition. The APCI probe process of gently nebulizing the sample to finely dispersed small droplets in a heated ceramic tube results in the rapid vaporization of the sample so that the sample molecules are not decomposed.

The following figure shows the reaction flow of the APCI process for reactant positive ions, the proton hydrates,  $\text{H}_3\text{O}^+[\text{H}_2\text{O}]_n$ .

Figure A-2 APCI Reaction Flow Diagram

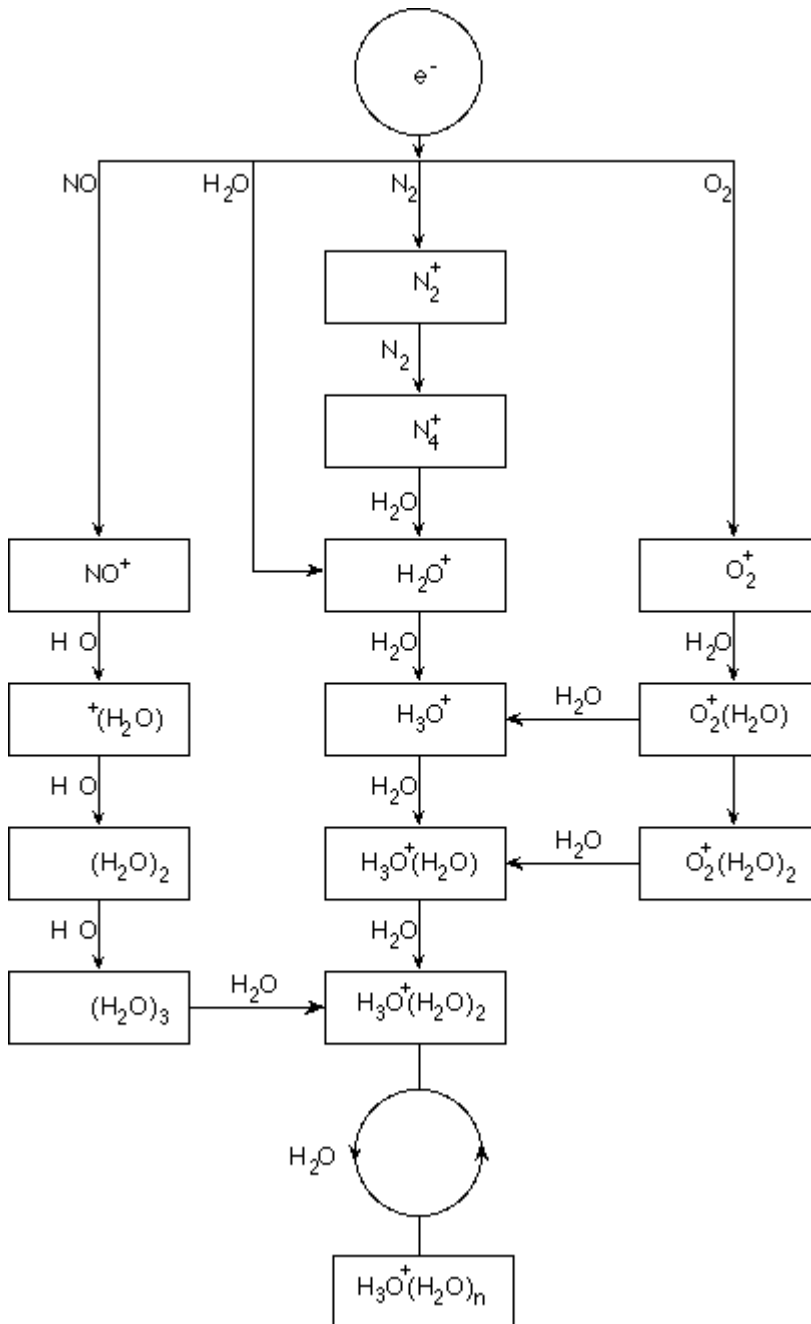

The major primary ions  $N_2^+$ ,  $O_2^+$ ,  $H_2O^+$ , and  $NO^+$  are formed by the electron impact of corona-created electrons on the major neutral components of air. Although  $NO^+$  is normally not a major constituent of clean air, the concentration of this species in the ion source is enhanced due to neutral reactions initiated by the corona discharge.

Samples that are introduced through the APCI probe are sprayed, with the aid of a nebulizer gas, in the heated ceramic tube. Within the tube, the finely dispersed droplets of sample and solvent undergo a rapid vaporization with minimal thermal decomposition. The gentle vaporization preserves the molecular identity of the sample.

The gaseous sample and solvent molecules pass to the ion source housing where the ionization by APCI is induced by a corona discharge needle connected to the end of the ceramic tube. The sample molecules are ionized by colliding with the reagent ions that are created by the ionization of mobile phase solvent molecules. The vaporized solvent molecules ionize to produce the reagent ions  $[X+H]^+$  in Positive polarity and  $[X-H]^-$  in Negative polarity. Refer to the figure: [Figure A-3](#). It is these reagent ions that produce stable sample ions when they collide with the sample molecules.

**Figure A-3 Atmospheric Pressure Chemical Ionization**

Item	Description
1	Sample
2	Primary ions are created in the vicinity of the corona discharge needle
3	Ionization produces predominantly solvent ions
4	Reagent ions react with sample molecules, forming clusters
5	Curtain plate
6	Interface

x = solvent molecules; M=sample molecules

The sample molecules are ionized through a process of proton transfer in Positive polarity and by either electron transfer or proton transfer in Negative polarity. The energy for the APCI ionization process is collision-dominated because of the relatively high atmospheric pressure of the ion source.

For reverse phase applications, the reagent ions consist of protonated solvent molecules in Positive polarity and solvated oxygen ions in Negative polarity. With favorable thermodynamics, the addition of modifiers changes the reagent ion composition. For example, the addition of acetate buffers or modifiers can make the acetate ion  $[CH_3COO]^-$  the primary reagent in Negative polarity. Ammonium modifiers might make protonated ammonia  $[NH_4]^+$  the primary reagent in Positive polarity.

Through collisions, an equilibrium distribution of certain ions, such as protonated water cluster ions, is maintained. The likelihood of premature fragmentation of the sample ions in the ion source is reduced because of the moderating influence of solvent clusters on the reagent ions

and the relatively high gas pressure in the ion source. As a result, the ionization process yields primarily molecular product ions for mass analysis in the mass spectrometer.

### APCI Ionization Region

The following figure shows the general location of the ion-molecule reactor of the APCI probe. The slanted lines indicate a wall-less reactor. A self-starting corona discharge ion current in the microampere range is created as a result of the electric field between the discharge needle and the curtain plate. Primary ions, for example,  $N_2^+$  and  $O_2^+$ , are created by the loss of electrons that originate in the plasma in the immediate vicinity of the discharge needle tip. The energy of these electrons is moderated by a number of collisions with gas molecules before attaining an energy where their effective ionization cross-section allows them to ionize neutral molecules efficiently.

**Figure A-4 APCI Ionization Region**

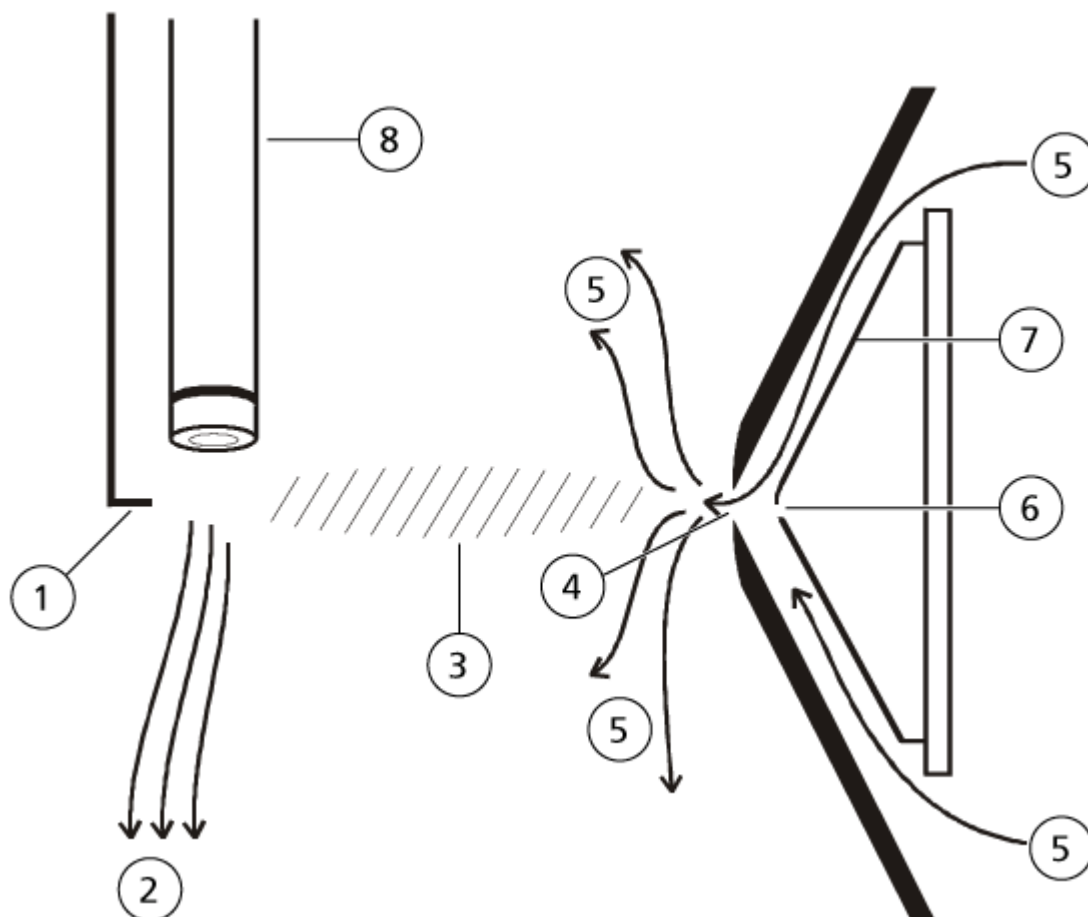

---

Item	Description
1	Discharge needle tip
2	Sample flow
3	Wall-less reactor
4	Curtain plate aperture
5	Gas for the Curtain Gas interface
6	Orifice
7	Orifice plate
8	Ceramic tube

The primary ions, in turn, generate intermediate ions that lead to the formation of sample ions. Ions of the chosen polarity drift under the influence of the electric field in the direction of the curtain plate and through the gas curtain to the mass analyzer. The whole ion formation process is collision-dominated because of the relatively high atmospheric pressure of the APCI probe. Except in the immediate vicinity of the discharge needle tip, where the strength of the electric field is greatest, the energy imparted to an ion by the electric field is small in comparison with the thermal energy of the ion.

Through collisions, an equal distribution of certain ions (for example, protonated water cluster ions) is maintained. Any excess energy that an ion might acquire in the ion-molecule reaction process is thermalized. Through collisional stabilization, many of the product ions are fixed, even though many subsequent collisions occur. The formation of both product ions and reactant ions is governed by equilibrium conditions at 760 torr (atmospheric) operating pressure.

The APCI probe functions as a wall-less reactor because the ions that pass from the ion source to the vacuum chamber and eventually to the detector never experience collisions with a wall—only collisions with other molecules. Ions are also formed outside the designated ion source, but are not detected and are eventually neutralized by interacting with a wall surface.

The temperature of the probe is an important factor for APCI probe operation. To preserve the molecular identity, the temperature must be set high enough to ensure a rapid evaporation. At a sufficiently high operating temperature, the droplets are vaporized quickly so that organic molecules are desorbed from the droplets with minimal thermal degradation. If, however, the temperature is set too low, the evaporation process is slower and pyrolysis, or decomposition, might occur before vaporization is complete. Operating the APCI probe at temperatures above the optimal temperature might cause thermal decomposition of the sample.

## TurbolonSpray Probe Parameters

The following table shows the recommended operating conditions for the TurbolonSpray probe at three different flow rates. For each flow rate, the flow rate of the gas for the Curtain Gas interface should be as high as possible. The solvent composition used for optimization was 1:1 water:acetonitrile. These conditions represent a starting point from which to optimize the probe. Using an iterative process, optimize the parameters using flow injection analysis to achieve the best signal or signal-to-noise for the compound of interest.

**Table B-1 Parameter Optimization for the TurbolonSpray Probe**

Parameters	Typical Values			Operational Range
	Low	Medium	High	
LC flow rate	5 $\mu\text{L}/\text{min}$ to 50 $\mu\text{L}/\text{min}$	200 $\mu\text{L}/\text{min}$	1,000 $\mu\text{L}/\text{min}$	5 $\mu\text{L}/\text{min}$ to 3,000 $\mu\text{L}/\text{min}$
Ion source gas 1 (nebulizer gas)	20 psi to 40 psi	40 psi to 60 psi	40 psi to 60 psi	0 psi to 90 psi
Ion source gas 2 (heater gas)	0 psi	50 psi	50 psi	0 psi to 90 psi
<b>IonSpray Voltage</b> <b>IonSpray Voltage</b> <b>Floating Spray voltage</b>	5500 V	5500 V	5500 V	5500 V
Gas for the Curtain Gas interface	20 psi	20 psi	20 psi	20 psi to 50 psi
Ion source temperature <sup>1</sup>	Ambient to 200 °C	200 °C to 650 °C	400 °C to 750 °C	Up to 750 °C

<sup>1</sup> Optimum temperature values depend on the compound and mobile phase composition. Higher aqueous content requires a higher temperature. Zero (0) means no temperature is applied.

Table B-1 Parameter Optimization for the TurbolonSpray Probe (continued)

Parameters	Typical Values			Operational Range
	Low	Medium	High	
Declustering potential (DP) <sup>2</sup>	Positive: 70 V Negative: -70 V	Positive: 70 V Negative: -70 V	Positive: 100 V Negative: -100 V	Positive: 0 V to 400 V Negative: -400 V to 0 V
Probe vertical micrometer setting	7 to 10	2 to 5	0 to 2	0 to 13
Probe horizontal micrometer setting	4 to 6	4 to 6	4 to 6	0 to 10

## APCI Probe Parameters

Table B-2 Parameter Optimization for the APCI Probe

Parameter	Typical Value	Operational Range
LC flow rate	1,000 $\mu\text{L}/\text{min}$	200 $\mu\text{L}/\text{min}$ to 3,000 $\mu\text{L}/\text{min}$
Ion source gas 1 (nebulizer gas)	30 psi	0 psi to 90 psi
Gas for the Curtain Gas interface	20 psi	20 psi to 50 psi
Ion source temperature <sup>3</sup>	400 $^{\circ}\text{C}$	100 $^{\circ}\text{C}$ to 750 $^{\circ}\text{C}$
Nebulizer current	Positive: 3 $\mu\text{A}$ Negative: -3 $\mu\text{A}$	Positive: 0 mA to 5 $\mu\text{A}$ Negative: -5 mA to 0 $\mu\text{A}$
Declustering potential (DP)	Positive: 60 V Negative: -60 V	Positive: 0 V to 300 V Negative: -300 V to 0 V
Probe vertical micrometer setting	4	Scale 0 to 13

<sup>2</sup> DP values depend on the compound.

<sup>3</sup> Temperature values depend on the compound.

## Parameter Descriptions

Table B-3 Source-Dependent Parameters

Parameter	Description
Ion source gas 1	Controls the nebulizer gas for the TurbolonSpray and APCI probes. Refer to the section: <a href="#">Principles of Operation — Ion Source</a> .
Ion source gas 2	Controls the heater gas for the TurbolonSpray probe. The best sensitivity is achieved when the combination of temperature and heater gas flow rate causes the LC solvent to reach a point at which it is nearly all vaporized. To optimize the ion source gas 2, increase the flow to obtain the best signal or signal-to-noise ratio if there is a significant increase in background noise. Too high a gas flow can produce a noisy or unstable signal. Refer to the section: <a href="#">Principles of Operation — Ion Source</a> .
Curtain gas	Controls the flow rate of the gas for the Curtain Gas interface. The Curtain Gas interface is located between the curtain plate and the orifice. It prevents ambient air and solvent droplets from entering and contaminating the ion optics, while permitting direction of sample ions in the vacuum chamber by the electrical fields generated between the vacuum interface and the spray needle. Contamination of the ion entrance optics reduces Q0 transmission, stability, and sensitivity, and increases background noise.  Maintain the flow rate of the gas for the Curtain Gas interface as high as possible without losing sensitivity.
Ion source temperature	Controls the heat applied to the sample to vaporize it. The optimal ion source temperature is the lowest temperature at which the sample is vaporized completely.  Optimize in increments of 50 °C.



Table B-3 Source-Dependent Parameters (continued)

Parameter	Description
Ion source temperature (TurboIonSpray probe)	<p>Controls the temperature of the heater gas in the TurboIonSpray probe.</p> <p>The best sensitivity is achieved when the combination of temperature and ion source gas 2 flow rate causes the LC solvent to reach a point at which it is nearly all vaporized.</p> <p>As the organic content of the solvent increases, the optimal probe temperature decreases. With solvents consisting of 100% methanol or acetonitrile, the probe performance might optimize as low as 300 °C. Aqueous solvents consisting of 100% water at flows of approximately 1,000 µL/min require a maximum probe temperature of 750 °C.</p> <p>If the ion source temperature is set too low, then vaporization is incomplete, and large, and visible droplets are expelled into the ion source housing.</p> <p>If the ion source temperature is set too high, then solvent might vaporize prematurely at the probe tip, especially if the probe is set too low (5 to 13).</p>
Ion source temperature (APCI probe)	<p>Controls the temperature of the APCI probe.</p> <p>As the organic content of the solvent increases, the optimal probe temperature should decrease. With solvents consisting of 100% methanol or acetonitrile the probe performance might optimize at temperatures as low as 400 °C at flow rates of 1,000 µL/min. Aqueous solvents consisting of 100% water set at flows of approximately 2,000 µL/min require a minimum probe temperature of 700 °C.</p> <p>If the ion source temperature is set too low, then vaporization is incomplete, and large, and visible droplets are expelled into the ion source housing.</p> <p>If the ion source temperature is set too high, then thermal degradation of the sample occurs.</p>

## Source Parameters and Voltages

---

**Table B-3 Source-Dependent Parameters (continued)**

Parameter	Description
Nebulizer current	Controls the current applied to the corona discharge needle in the APCI probe. The discharge ionizes solvent molecules, which in turn ionize the sample molecules. For the APCI probe, the current applied to the corona discharge needle usually optimizes over a broad range of about 1 $\mu$ A to 5 $\mu$ A, in Positive polarity. To optimize, start at a value of 1 and then increase to achieve the best signal or signal-to-noise ratio. If, when the current is increased, no changes in signal are observed, then leave the current at the lowest setting that provides the best sensitivity, for example, 2 $\mu$ A.
Ion source voltage	Controls the voltage applied to the sprayer in the TurbolonSpray probe, which ionizes the sample in the ion source. The parameter value depends on the polarity, and affects the stability of the spray and the sensitivity.  In the Analyst software, this is the <b>IonSpray Voltage</b> field, in Analyst TF, it is the <b>IonSpray Voltage Floating</b> field, and in SCIEX OS it is the <b>Spray voltage</b> field.
Interface heater	This parameter is always on for SCIEX 3500, 4500, 5500, 5500+, 6500, 6500+, and TripleTOF systems.  Turns the interface heater on and off. Heating the interface helps maximize the ion signal and prevents contamination of the ion optics. Unless the compound the user is analyzing is extremely fragile, we recommend that the user heat the interface.

## Probe Position

The position of the probe can affect the sensitivity of the analysis. For more information on how to optimize the position of the probe, refer to the section: [Ion Source Optimization](#).

## Solvent Composition

The standard concentration of ammonium formate or ammonium acetate is from 2 mmol/L to 10 mmol/L for positive ions and 2 mmol/L to 50 mmol/L for negative ions. The concentration of organic acids is 0.1% to 0.5% by volume for the TurbolonSpray probe and 0.1% to 1.0% by volume for the APCI probe.

Commonly used solvents are:

- Acetonitrile

- Methanol
- Propanol
- Water

Commonly used modifiers are:

- Acetic acid
- Formic acid
- Ammonium formate
- Ammonium acetate

The following modifiers are not commonly used because they complicate the spectrum with their ion mixtures and cluster combinations. They might also suppress the strength of the target compound ion signal.

- Triethyl amine (TEA)
- Sodium phosphate
- Trifluoroacetic acid (TFA)
- Sodium dodecyl sulfate

# Ion Source Optimization (Analyst/ Analyst TF Software)

# C

The procedures in this section are for optimizing using the Analyst and Analyst TF software only. For optimization using SCIEX OS, refer to the section: [Source Optimization Procedures \(SCIEX OS\)](#).

## TurbolonSpray Probe Optimization



**WARNING!** Ionizing Radiation Hazard, Biohazard, or Toxic Chemical Hazard. Make sure that the source exhaust system is connected and functioning, and that good general laboratory ventilation is provided. Adequate laboratory ventilation is required to control solvent and sample emissions, and to provide for the safe operation of the system.



**WARNING!** Fire Hazard. Do not direct more than 3 mL/min of flammable solvent in the ion source. Exceeding the maximum flow rate can cause solvent to accumulate in the ion source. Do not use the ion source if the source exhaust system is not enabled and functioning when the ion source and the probe are properly installed.



**WARNING!** Ionizing Radiation Hazard, Biohazard, or Toxic Chemical Hazard. Make sure that the electrode protrudes beyond the tip of the probe, to prevent hazardous vapors from escaping from the source. The electrode must not be recessed within the probe.

**CAUTION:** Potential System Damage. If the LC system connected to the mass spectrometer is not controlled by the software, then do not leave the mass spectrometer unattended while in operation. The liquid stream from the LC system can flood the ion source when the mass spectrometer goes in Standby state.

**Note:** To keep the system clean and at optimum performance, adjust the probe position when changing the flow rate.

**Tip!** It is easier to optimize signal and signal-to-noise with flow injection analysis than with on-column injections.

**Note:** If the ion source voltage is too high, then a corona discharge can occur. In the Analyst software, this is the **IonSpray Voltage** field. In the Analyst TF software, this is the **IonSpray Voltage Floating** field. In SCIEX OS, this is the **Spray voltage** field. A corona discharge is visible as a blue glow at the tip of the probe. It results in decreased sensitivity and stability of the signal.

---

### Set Up the System

1. Configure the LC pump to deliver the mobile phase at the required flow rate. Refer to the section: [Source Parameters and Voltages](#).
2. Connect the grounding union on the ion source to an LC pump, through an injector equipped with a loop, or to an autosampler.
3. If an autosampler is being used, then configure the autosampler to perform multiple injections.

### Prepare the System

1. Open the control software.
2. On the Navigation bar, under **Tune and Calibrate** mode, double-click **Manual Tuning**.
3. Open a previously optimized method or create a method based on the compounds.
4. If the ion source has been allowed to cool, then do the following.
  - a. Set the ion source temperature to 450.
  - b. Let the ion source warm up for 30 minutes.

The 30-minute warm-up stage prevents solvent vapors from condensing in the cold probe.
5. Start the solvent flow and sample injection.

### Set the Starting Conditions

1. In the Tune Method Editor, make sure that the correct **Scan Type** and appropriate compound parameters are selected.
2. Type a starting value for **Ion Source Gas 1**.

For LC pumps, use a value between 40 and 60 for Gas 1.
3. Type a starting value for **Ion Source Gas 2 (GS2)**.

For LC pumps, use a value between 30 and 50 for Gas 2.

---

**Note:** Gas 2 is used with higher flow rates typical with an LC system and in conjunction with increased temperature.

---

## Ion Source Optimization (Analyst/Analyst TF Software)

---

4. In the **IonSpray Voltage (IS)** or **IonSpray Voltage Floating (ISVF)** field, type the value appropriate to the mass spectrometer.

**Table C-1 IS or ISVF Parameter Values**

Mass Spectrometer	Starting Value
SCIEX 3500, 4000, 4500, 5000, 5500, 5500+, 6500, and 6500+ systems	4500
TripleTOF 5600, 5600+, 6600, and 6600+ systems	5500

5. In the **Curtain Gas (CUR)** field, type the value appropriate to the mass spectrometer.

**Table C-2 CUR Parameter Values**

Mass Spectrometer	Starting Value
SCIEX 3500, 4000, and 4500 systems	20
SCIEX 5000, 5500, and 5500+ systems	25
SCIEX 6500 and 6500+ systems	30
TripleTOF 5600, 5600+, 6600, and 6600+ systems	20 to 25, depending on the flow rate

6. Type 45 in the **Collision Energy** field.
7. Start acquisition.

## APCI Probe Optimization



---

**WARNING! Ionizing Radiation Hazard, Biohazard, or Toxic Chemical Hazard. Make sure that the source exhaust system is connected and functioning, and that good general laboratory ventilation is provided. Adequate laboratory ventilation is required to control solvent and sample emissions, and to provide for the safe operation of the system.**

---



---

**WARNING! Fire Hazard. Do not direct more than 3 mL/min of flammable solvent in the ion source. Exceeding the maximum flow rate can cause solvent to accumulate in the ion source. Do not use the ion source if the source exhaust system is not enabled and functioning when the ion source and the probe are properly installed.**

---



**WARNING!** Ionizing Radiation Hazard, Biohazard, or Toxic Chemical Hazard. Make sure that the electrode protrudes beyond the tip of the probe, to prevent hazardous vapors from escaping from the source. The electrode must not be recessed within the probe.

---

**CAUTION: Potential System Damage.** If the LC system connected to the mass spectrometer is not controlled by the software, then do not leave the mass spectrometer unattended while in operation. The liquid stream from the LC system can flood the ion source when the mass spectrometer goes in Standby state.

---

**Note:** The minimum flow rate supported by the APCI probe is 200  $\mu\text{L}/\text{min}$ . For a complete list of APCI probe parameters, refer to the section: [APCI Probe Parameters](#).

---

**Tip!** It is easier to optimize signal and signal-to-noise with flow injection analysis than with on-column injections.

---

**Note:** When using the APCI probe, make sure that the corona discharge needle is pointing toward the aperture.

---

## Set Up the System

1. Configure the LC pump to deliver the mobile phase at the required flow rate. Refer to the section: [Source Parameters and Voltages](#).
2. Connect the grounding union on the ion source to an LC pump, through an injector equipped with a loop, or to an autosampler.
3. If an autosampler is being used, then configure the autosampler to perform multiple injections.

## Prepare the System

1. Open the control software.
2. On the Navigation bar, under **Tune and Calibrate** mode, double-click **Manual Tuning**.
3. Open a previously optimized method or create a method based on the compounds.
4. If the ion source has been allowed to cool, then do the following.
  - a. Set the ion source temperature to 450.
  - b. Let the ion source warm up for 30 minutes.

The 30-minute warm-up stage prevents solvent vapors from condensing in the cold probe.
5. Start the solvent flow and sample injection.

### Set the Starting Conditions

1. In the Tune Method Editor, make sure that the correct **Scan Type** and appropriate compound parameters are selected.
2. Type 30 in the **Ion Source Gas 1 (GS1)** field. Type 30 in the **Ion Source Gas 1** field.
3. In the Curtian Gas (CUR) field, type the value appropriate to the mass spectrometer.

**Table C-3 CUR Parameter Values**

Mass Spectrometer	Starting Value
SCIEX 3500, 4000, and 4500 systems	20
SCIEX 5000, 5500, and 5500+ systems	25
SCIEX 6500 and 6500+ systems	30
TripleTOF 5600, 5600+, 6600, 6600+ systems	20 to 25, depending on the flow rate

4. Type 1 in the **Nebulizer Current (NC)** field.
5. On the Compound tab, in the **Declustering potential (DP)** field, type 100.
6. Type 45 in the **Collision Energy** field.
7. Start acquisition.

### Optimize Source and Gas Parameters

1. Adjust ion source gas 1 in increments of five to achieve the best signal or signal-to-noise ratio.
2. Increase the flow rate of the gas for the Curtian Gas interface until the signal starts to decrease.



**Note:** To prevent contamination, use the highest possible value for the flow rate of the gas for the Curtain Gas interface that does not sacrifice sensitivity. Do not set the flow rate lower than the values in the table: [Table C-4](#). This helps to prevent penetration of the flow of the gas for the Curtain Gas interface, which can produce a noisy signal; prevent contamination of the aperture; and increase the overall signal-to-noise ratio.

**Table C-4 CUR Parameter Values**

Mass Spectrometer	Starting Value
SCIEX 3500, 4000, and 4500 systems	20
SCIEX 5000, 5500, and 5500+ systems	25
SCIEX 6500 and 6500+ systems	30
TripleTOF 5600, 5600+, 6600, and 6600+ systems	20 to 25, depending on the flow rate

## Adjust the Position of the Corona Discharge Needle



**WARNING! Electrical Shock Hazard.** Follow this procedure to avoid contact with the high voltages applied to the corona discharge needle, curtain plate, and turbo heaters.

### Required Materials

- Insulated flat-bladed screwdriver

When using the APCI probe, make sure that the corona discharge needle is pointing toward the aperture. When using the TurbolonSpray probe, make sure that the corona discharge needle is pointed away from the aperture.

1. Use an insulated flat-bladed screwdriver to rotate the corona discharge needle adjustment screw on the top of the needle.
2. Look through the glass window to make sure that the needle is aligned with the tip facing the aperture.

## Optimize the APCI Probe Position



**WARNING! Ionizing Radiation Hazard, Biohazard, or Toxic Chemical Hazard.** Make sure that the electrode protrudes beyond the tip of the probe, to prevent hazardous vapors from escaping from the source. The electrode must not be recessed within the probe.

## Ion Source Optimization (Analyst/Analyst TF Software)



**WARNING! Puncture Hazard. Be careful when handling the electrode. The tip of the electrode is extremely sharp.**

Make sure that the curtain plate aperture remains clear of solvent or solvent droplets at all times.

The position of the sprayer nozzle affects sensitivity and signal stability. Adjust the probe position in small increments only. At lower flow rates, move the probe closer to the aperture. For higher flow rates, move the probe farther away from the aperture. After the probe is optimized, it needs only minor adjustment. If the probe is removed, or if the analyte, flow rate, or solvent composition changes, then repeat the optimization procedure.

**Figure C-1 Sprayer Nozzle Position**

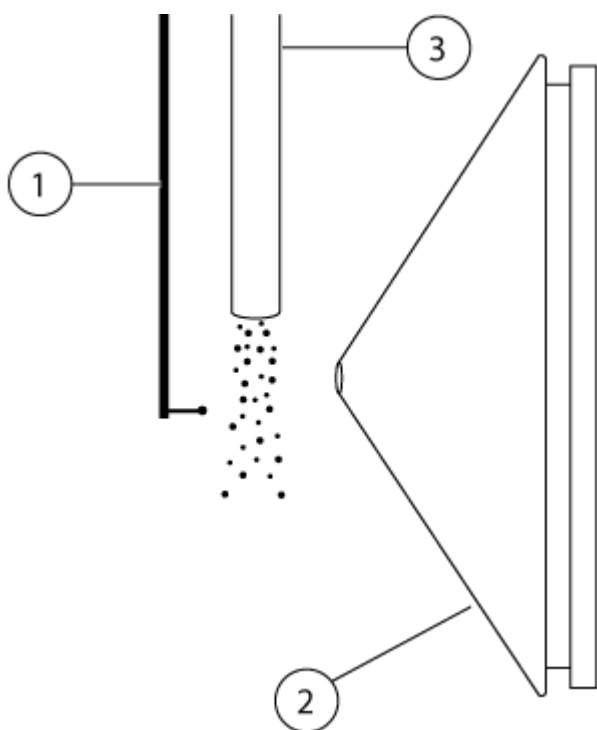

Item	Description
1	Corona discharge needle
2	Curtain plate
3	APCI probe

1. Use the previous horizontal and vertical micrometer settings or set them to 5 as a starting position.

**Note:** To avoid reducing the performance of the mass spectrometer, do not spray directly in the aperture.

---

2. In the control software, monitor the signal or signal-to-noise of the analytes.
  3. Use the horizontal micrometer to adjust the probe in small increments to achieve the best signal or signal-to-noise ratio.
  4. Use the vertical micrometer to adjust the probe in small increments to achieve the best signal or signal-to-noise ratio.
  5. Adjust the black electrode adjustment nut on the probe to move the electrode tube in or out of the probe (to adjust the protrusion).
- 

**Note:** The electrode tip should protrude between 0.5 mm and 1.0 mm from the end of the probe.

---

The optimal setting for the electrode tip is compound-dependent. The distance that the electrode tip protrudes affects the shape of the spray cone, and the shape of the spray cone affects mass spectrometer sensitivity.

**Figure C-2 Electrode Tip Extension Adjustment**

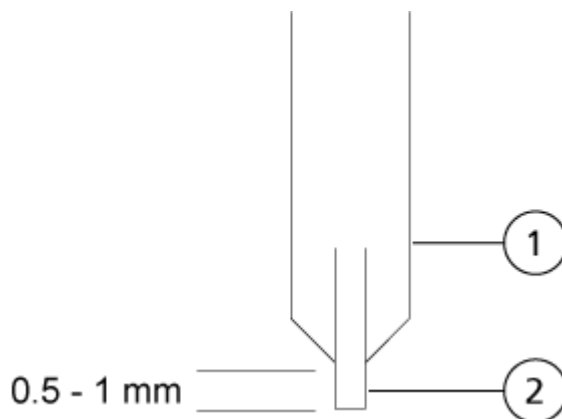

Item	Description
1	Probe
2	Electrode

## Optimize the Nebulizer Current

The ion source is controlled by current and not by voltage. Select the appropriate current for the acquisition method, regardless of the ion source selection position.

## **Ion Source Optimization (Analyst/Analyst TF Software)**

---

Start with a nebulizer current value of 3 and then increase or decrease it to achieve the best signal or signal-to-noise ratio.

The nebulizer current applied to the corona discharge needle usually optimizes between 1  $\mu\text{A}$  and 5  $\mu\text{A}$  in either polarity. If no changes in signal are observed when the current is increased, then leave the current at the lowest value that provides the best signal or signal-to-noise ratio.

## **Optimize the APCI Probe Temperature**









The quantity and type of solvent affects the optimal APCI probe temperature. At higher flow rates, the optimal temperature increases.

Adjust the ion source temperature in increments of 50 °C to 100 °C to achieve the best signal or signal-to-noise ratio.









# Glossary of Symbols

# D











**Note:** Not all of the symbols in the following table are applicable to every instrument.

Symbol	Description
	Australian Regulatory Compliance Mark. Indicates that the product complies with Australian Communications Media Authority (ACMA) EMC Requirements.
	Alternating current
A	Amperes (current)
	Asphyxiation Hazard
	Authorized representative in the European community
	Biohazard
	CE Marking of Conformity
	cCSAus mark. Indicates electrical safety certification for Canada and USA.
	Catalog number

## Glossary of Symbols

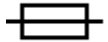









Symbol	Description
	<p>Caution. Consult the instructions for information about a possible hazard.</p> <hr/> <p><b>Note:</b> In SCIEX documentation, this symbol identifies a personal injury hazard.</p> <hr/>
	<p>China RoHS Caution Label. The electronic information product contains certain toxic or hazardous substances. The center number is the Environmentally Friendly Use Period (EFUP) date, and indicates the number of calendar years the product can be in operation. Upon the expiration of the EFUP, the product must be immediately recycled. The circling arrows indicate the product is recyclable. The date code on the label or product indicates the date of manufacture.</p>
	<p>China RoHS logo. The device does not contain toxic and hazardous substances or elements above the maximum concentration values and it is an environmentally-friendly product that can be recycled and reused.</p>
	<p>Consult instructions for use.</p>
	<p>Crushing Hazard</p>
	<p>cTUVus mark for TUV Rheinland of North America</p>
	<p>Data Matrix symbol that can be scanned by a barcode reader to obtain a unique device identifier (UDI)</p>
	<p>Environmental Hazard</p>

## Glossary of Symbols











Symbol	Description
	Ethernet connection
	Explosion Hazard
	Eye Injury Hazard
	Fire Hazard
	Flammable Chemical Hazard
	Fragile
	Fuse
Hz	Hertz
	International safety symbol "Caution, risk of electric shock" (ISO 3864), also known as High Voltage symbol If the main cover must be removed, then contact a SCIEX representative to prevent electric shock.
	Hot Surface Hazard
	In Vitro Diagnostic Device

## Glossary of Symbols



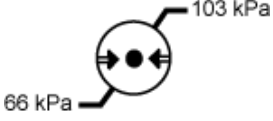

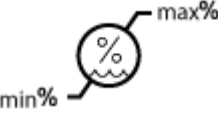

---

Symbol	Description
	Ionizing Radiation Hazard
	Keep dry. Do not expose to rain. Relative humidity must not exceed 99%.
	Keep upright.
	Lacerate/Sever Hazard
	Laser Radiation Hazard
	Lifting Hazard
	Magnetic Hazard
	Manufacturer
	Moving Parts Hazard
	Pacemaker Hazard. No access to people with pacemakers.

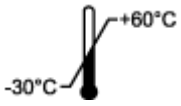

Symbol	Description
	Pinching Hazard
	Pressurized Gas Hazard
	Protective Earth (ground)
	Puncture Hazard
	Reactive Chemical Hazard
	Serial number
	Toxic Chemical Hazard
	Transport and store the system within 66 kPa to 103 kPa.
	Transport and store the system within 75 kPa to 101 kPa.
	Transport and store the system within the specified minimum ( <b>min</b> ) and maximum ( <b>max</b> ) levels of relative humidity, noncondensing.
	Transport and store the system within $-30\text{ }^{\circ}\text{C}$ to $+45\text{ }^{\circ}\text{C}$ .

## Glossary of Symbols

Symbol	Description
	Transport and store the system within $-30\text{ }^{\circ}\text{C}$ to $+60\text{ }^{\circ}\text{C}$ .
	USB 2.0 connection
	USB 3.0 connection
	Ultraviolet Radiation Hazard
	United Kingdom Conformity Assessment Mark
VA	Volt Ampere (power)
V	Volts (voltage)
	WEEE. Do not dispose of equipment as unsorted municipal waste. Environmental Hazard
W	Watts
	<i>yyyy-mm-dd</i> Date of manufacture

# Contact Us

---

## Customer Training

- In North America: [NA.CustomerTraining@sciex.com](mailto:NA.CustomerTraining@sciex.com)
- In Europe: [Europe.CustomerTraining@sciex.com](mailto:Europe.CustomerTraining@sciex.com)
- Outside the EU and North America, visit [sciex.com/education](http://sciex.com/education) for contact information.

## Online Learning Center

- [SCIEX Now Learning Hub](#)

## SCIEX Support

SCIEX and its representatives maintain a staff of fully-trained service and technical specialists located throughout the world. They can answer questions about the system or any technical issues that might arise. For more information, visit the SCIEX website at [sciex.com](http://sciex.com) or contact us in one of the following ways:

- [sciex.com/contact-us](http://sciex.com/contact-us)
- [sciex.com/request-support](http://sciex.com/request-support)

## CyberSecurity

For the latest guidance on cybersecurity for SCIEX products, visit [sciex.com/productsecurity](http://sciex.com/productsecurity).

## Documentation

This version of the document supersedes all previous versions of this document.

To view this document electronically, Adobe Acrobat Reader is required. To download the latest version, go to <https://get.adobe.com/reader>.

To find software product documentation, refer to the release notes or software installation guide that comes with the software.

To find hardware product documentation, refer to the documentation DVD for the system or component.

## Contact Us

---

The latest versions of the documentation are available on the SCIEX website, at [sciex.com/customer-documents](https://sciex.com/customer-documents).

---

**Note:** To request a free, printed version of this document, contact [sciex.com/contact-us](https://sciex.com/contact-us).

---