

# TripleTOF 6600+ System

## System User Guide



---

This document is provided to customers who have purchased SCIEX equipment to use in the operation of such SCIEX equipment. This document is copyright protected and any reproduction of this document or any part of this document is strictly prohibited, except as SCIEX may authorize in writing.

Software that may be described in this document is furnished under a license agreement. It is against the law to copy, modify, or distribute the software on any medium, except as specifically allowed in the license agreement. Furthermore, the license agreement may prohibit the software from being disassembled, reverse engineered, or decompiled for any purpose. Warranties are as stated therein.

Portions of this document may make reference to other manufacturers and/or their products, which may contain parts whose names are registered as trademarks and/or function as trademarks of their respective owners. Any such use is intended only to designate those manufacturers' products as supplied by SCIEX for incorporation into its equipment and does not imply any right and/or license to use or permit others to use such manufacturers' and/or their product names as trademarks.

SCIEX warranties are limited to those express warranties provided at the time of sale or license of its products and are the sole and exclusive representations, warranties, and obligations of SCIEX. SCIEX makes no other warranty of any kind whatsoever, expressed or implied, including without limitation, warranties of merchantability or fitness for a particular purpose, whether arising from a statute or otherwise in law or from a course of dealing or usage of trade, all of which are expressly disclaimed, and assumes no responsibility or contingent liability, including indirect or consequential damages, for any use by the purchaser or for any adverse circumstances arising therefrom.

(GEN-IDV-09-10816-D)

For Research Use Only. Not for use in Diagnostic Procedures.

Trademarks and/or registered trademarks mentioned herein, including associated logos, are the property of AB Sciex Pte. Ltd., or their respective owners, in the United States and/or certain other countries (see [sciex.com/trademarks](http://sciex.com/trademarks)).

AB Sciex™ is being used under license.

© 2022 DH Tech. Dev. Pte. Ltd.



AB Sciex Pte. Ltd.  
Blk33, #04-06 Marsiling Industrial Estate Road 3  
Woodlands Central Industrial Estate, Singapore 739256

# Contents

---

<b>1 Operational Precautions and Limitations</b> .....	<b>7</b>
General Safety Information.....	7
Documentation Symbols and Conventions.....	7
Regulatory Compliance.....	8
Australia and New Zealand.....	8
Canada.....	8
Europe.....	8
United States.....	9
International.....	9
Electrical Precautions.....	10
Mains Supply.....	10
Protective Earth Conductor.....	10
Chemical Precautions.....	11
System Safe Fluids.....	12
Ventilation Precautions.....	13
Physical Precautions.....	14
Environmental Precautions.....	14
Electromagnetic Environment.....	15
Decommissioning and Disposal.....	16
Qualified Personnel.....	16
Laboratory Conditions.....	17
Safe Environmental Conditions.....	17
Performance Specifications.....	17
Equipment Use and Modification.....	17
<b>2 Principles of Operation</b> .....	<b>19</b>
System Overview.....	19
Hardware Overview.....	19
Panel Symbols.....	23
Theory of Operation.....	24
Data Handling.....	25
<b>3 Operating Instructions</b> .....	<b>26</b>
Start Up the System.....	26
Shut Down the System.....	27
Adjust the Integrated Syringe Pump Position.....	28

## Contents

---

Reset the Syringe Pump.....	31
<b>4 Operating Instructions — Sample Workflows.....</b>	<b>33</b>
<b>5 Operating Instructions — Hardware Profiles and Projects.....</b>	<b>37</b>
Hardware Profiles.....	37
Create a Hardware Profile.....	37
Add Devices to a Hardware Profile.....	42
Troubleshoot Hardware Profile Activation.....	44
Projects and Subprojects.....	45
Create Projects and Subprojects.....	45
Create Subprojects.....	47
Copy Subprojects.....	47
Change Between Projects and Subprojects.....	47
Installed Project Folders.....	48
Back Up the API Instrument Folder.....	49
Recover the API Instrument Folder.....	49
<b>6 Operating Instructions — Tune and Calibrate.....</b>	<b>50</b>
Optimize the Mass Spectrometer.....	51
Verifying or Adjusting Performance Dialog.....	52
Results Summary.....	52
<b>7 Operating Instructions — Acquisition Methods.....</b>	<b>54</b>
Create an Acquisition Method Using the Acquisition Method Editor.....	54
Add an Experiment.....	55
Add a Period.....	56
Copy an Experiment into a Period.....	56
Copy an Experiment within a Period.....	56
Create an Acquisition Method using the Method Wizard.....	56
Scan Techniques.....	57
Single Mass Spectrometry.....	57
Quadrupole-Based Single Mass Spectrometry.....	57
Time-of-Flight Single Mass Spectrometry.....	58
Tandem Mass Spectrometry.....	58
Product Ion Mass Spectrometry.....	58
Precursor Ion Mass Spectrometry.....	58
About Spectral Data Acquisition.....	58
MS Parameters.....	59
<b>8 Operating Instructions — Batches.....</b>	<b>64</b>
Set Queue Options.....	64

---

Add Sets and Samples to a Batch .....	66
Submit a Sample or Set of Samples .....	69
Set Up Sample Calibration .....	69
Change Sample Order .....	70
Acquire Data .....	70
Set Sample Locations in the Batch Editor .....	71
Select Vial Positions Using the Locations Tab (Optional) .....	71
Stop Sample Acquisition .....	72
Queue States and Device Status .....	73
Queue States .....	73
View Instrument and Device Status Icons .....	74
<b>9 Operating Instructions — Analyze and Explore Data .....</b>	<b>76</b>
Open Data Files .....	76
Navigate Between Samples in a Data File .....	77
View Experimental Conditions .....	77
Show Data in Tables .....	77
Show ADC Data .....	79
Show Basic Quantitative Data .....	79
Chromatograms .....	80
Show TICs from a Spectrum .....	81
Show a Spectrum from a TIC .....	82
Generate XICs .....	83
Generate an XIC Using a Selected Range .....	83
Generate an XIC Using the Maximum Peak .....	84
Generate an XIC Using Base Peak Masses .....	84
Extract Ion by Selecting Masses .....	84
Generate BPCs .....	85
Generate XWCs .....	87
Show DAD Data .....	87
Generate TWCs .....	88
Adjust the Threshold .....	88
Graphical Data Processing .....	89
Graphs .....	89
Manage Data .....	89
Zoom In on the Y-axis .....	91
Zoom In on the X-axis .....	91
<b>10 Service and Maintenance Information .....</b>	<b>92</b>
Recommended Maintenance Schedule .....	92
Clean the Surfaces .....	94
Clean the Front-End .....	95
Symptoms of Contamination .....	95

## Contents

---

Required Materials .....	96
Cleaning Best Practices .....	97
Prepare the Mass Spectrometer .....	98
Clean the Curtain Plate .....	99
Clean the Front of the Orifice Plate .....	101
Put the Mass Spectrometer Back in Service .....	101
Empty the Source Exhaust Drain Bottle .....	101
Inspect the Roughing Pump Oil Level .....	104
Replace the Mass Spectrometer Cooling Fans Filter .....	105
Storage and Handling .....	107
<b>11 Mass Spectrometer Troubleshooting .....</b>	<b>109</b>
<b>A Recommended Calibration Ions .....</b>	<b>114</b>
<b>B Exact Masses and Chemical Formulas .....</b>	<b>117</b>
<b>C Toolbar Icons .....</b>	<b>121</b>
<b>D Right-Click Menus .....</b>	<b>132</b>
Batch Editor .....	132
Queue .....	133
Show File Information Pane Right-click Menu .....	134
Chromatogram Panes .....	134
Spectra Panes .....	135
Results Table .....	136
Peak Review .....	137
Calibration Curve .....	138
<b>E Glossary of Symbols .....</b>	<b>140</b>
<b>F Glossary of Warnings .....</b>	<b>146</b>
<b>Contact Us .....</b>	<b>148</b>
Customer Training .....	148
Online Learning Center .....	148
SCIEX Support .....	148
CyberSecurity .....	148
Documentation .....	148

# Operational Precautions and Limitations

# 1

---

**Note:** Before operating the system, carefully read all of the sections of this guide.

---

This section contains general safety-related information and provides regulatory compliance information. It also describes potential hazards and associated warnings for the system and the precautions that should be taken to minimize the hazards.

In addition to this section, for information about the symbols and conventions used in the laboratory environment, on the system, and in this documentation, refer to the section: [Glossary of Symbols](#). For site requirements, including mains supply, source exhaust, ventilation, compressed air, nitrogen, and roughing pump requirements, refer to the document: *Site Planning Guide*.

## General Safety Information

To prevent personal injury or system damage, read, understand, and obey all of the safety precautions and warnings in this document, the manufacturer chemical safety data sheets (SDSs), and product label information. Labels are shown with internationally recognized symbols. Failure to heed these warnings could result in serious injury.

This safety information is intended to supplement federal, state, provincial, and local environmental health and safety (EHS) regulations. The information provided covers system-related safety information applicable to the operation of the system. It does not cover every safety procedure that should be practiced. Ultimately, the user and the organization are responsible for compliance with federal, state, provincial, and local EHS regulations and for maintaining a safe laboratory environment.

Refer to the appropriate laboratory reference material and standard operating procedures.

## Documentation Symbols and Conventions

The following symbols and conventions are used throughout the guide.



---

**DANGER!** Danger signifies an action that leads to severe injury or death.

---



---

**WARNING!** Warning signifies an action that could cause personal injury if precautions are not followed.

---

## Operational Precautions and Limitations

---

**CAUTION:** Caution signifies an operation that could cause damage to the system or corruption or loss of data if precautions are not followed.

---

**Note:** Note emphasizes significant information in a procedure or description.

---

**Tip!** Tip provides useful information that helps apply the techniques and procedures in the text for a specific need and provides shortcuts, but is not essential to the completion of a procedure.

---

## Regulatory Compliance

This system complies with the regulations and standards listed in this section. For dated references, refer to the *Declaration of Conformity* included with the system and the individual system components. Applicable labels have been affixed to the system.

### Australia and New Zealand

- **Electromagnetic Compatibility (EMC):** Radio Communications Act 1992 as implemented in these standards:
  - Electromagnetic Interference—AS/NZS CISPR 11/ EN 55011/ CISPR 11 (Class A). Refer to the section: [Electromagnetic Interference](#).
- **Safety:** AS/NZ 61010-1 and IEC 61010-2-061

### Canada

- **Electromagnetic Interference (EMI):** CAN/CSA CISPR11. This ISM device complies with Canadian ICES-001. Refer to the section: [Electromagnetic Interference](#).
- **Safety:**
  - CAN/CSA C22.2 No. 61010-1
  - CAN/CSA C22.2 No 61010-2-061

### Europe

- **Electromagnetic Compatibility (EMC):** Electromagnetic Compatibility Directive 2014/30/EU as implemented in these standards:
  - EN 61326-1
  - EN 55011 (Class A)Refer to the section: [Electromagnetic Compatibility](#).
- **Safety:** Low Voltage Directives 2014/35/EU as implemented in these standards:



- EN 61010-1
- EN 61010-2-061
- **Waste Electrical and Electronic Equipment (WEEE):** Waste Electrical and Electronic Equipment Directive 2012/96/EEC, as implemented in EN 40519. Refer to the section: [Waste Electrical and Electronic Equipment](#).
- **Packaging and Packaging Waste (PPW):** Packaging and Packaging Waste Directive 94/62/EC
- **RoHS Restriction of Hazardous Substances:** RoHS Directive 2011/65/EU

### United States

- **Radio Emissions Interference Regulations:** 47 CFR 15, as implemented in FCC Part 15 (Class A)
- **Safety:** Occupational Safety and Health Regulations, 29 CFR 1910, as implemented in these standards:
  - UL 61010-1
  - IEC 61010-2-061

### International

- **Electromagnetic Compatibility (EMC):**
  - IEC 61326-1
  - IEC CISPR 11 (Class A)
  - IEC 61000-3-2
  - IEC 61000-3-3Refer to the section: [Electromagnetic Compatibility](#).
- **Safety:**
  - IEC 61010-1
  - IEC 61010-2-061

## Electrical Precautions



**WARNING! Electrical Shock Hazard. Do not remove the covers. Removing the covers might cause injury or malfunctioning of the system. The covers need not be removed for routine maintenance, inspection, or adjustment. Contact a SCIEX Field Service Employee (FSE) for repairs that require the covers to be removed.**

---

- Follow required electrical safe work practices.
- Use cable management practices to control electrical cables. This will decrease the chance of a tripping hazard.

For information about system electrical specifications, refer to the document: *Site Planning Guide*.

## Mains Supply

Connect the system to a compatible mains supply as instructed in this guide.



**WARNING! Electrical Shock Hazard. Use only qualified personnel for the installation of all of the electrical supplies and fixtures, and make sure that all of the installations adhere to local regulations and safety standards.**

---



**WARNING! Electrical Shock Hazard. Make sure that the system can be disconnected from the mains supply outlet in an emergency. Do not block the mains supply outlet.**

---



**WARNING! Electrical Shock Hazard. Use only the mains supply cables supplied with the system. Do not use mains supply cables that are not properly rated for the operation of this system.**

---

An external line transformer is not needed for the mass spectrometer or roughing pump.

## Protective Earth Conductor

The mains supply must include a correctly installed protective earth conductor. The protective earth conductor must be installed or examined by a qualified electrician before the system is connected.



**WARNING! Electrical Shock Hazard. Do not intentionally interrupt the protective earth conductor. Any interruption of the protective earth conductor creates an electrical shock hazard.**

---



**WARNING! Electrical Shock Hazard.** Make sure that a protective earth conductor (grounding cable) is connected between the sample loop and an appropriate grounding point at the ion source. This supplementary grounding reinforces the safety configuration specified by SCIEX.

---

## Chemical Precautions



**WARNING! Ionizing Radiation Hazard, Biohazard, or Toxic Chemical Hazard.** Determine whether decontamination is required before cleaning or maintenance. If radioactive materials, biological agents, or toxic chemicals have been used with the system, then the customer must decontaminate the system before cleaning or maintenance.

---



**WARNING! Puncture Hazard, Ionizing Radiation Hazard, Biohazard, or Toxic Chemical Hazard.** Discontinue use of the ion source if the ion source window is cracked or broken, and then contact a SCIEX Field Service Employee (FSE). Any toxic or injurious materials introduced in the equipment will be present in the source exhaust output. Exhaust from equipment should be vented from the room. Dispose of sharps following established laboratory safety procedures.

---



**WARNING! Environmental Hazard.** Do not dispose of system components in municipal waste. Follow local regulations when disposing of components.

---



**WARNING! Biohazard or Toxic Chemical Hazard.** Connect the drain tubing to the mass spectrometer and the source exhaust drain bottle properly, to prevent leaks.

---

- Determine which chemicals have been used in the system prior to service and regular maintenance. For the health and safety precautions that must be followed for a chemical, refer to the document: *Safety Data Sheet*. For storage information, refer to the document: *Certificate of Analysis*. To find a SCIEX *Safety Data Sheet* or *Certificate of Analysis*, go to [sciex.com/tech-regulatory](http://sciex.com/tech-regulatory).
- Always wear assigned personal protective equipment, including powder-free gloves, safety glasses, and a laboratory coat.

**Note:** Nitrile or neoprene gloves are recommended.

---

- Work in a well-ventilated area or fume hood.
- Avoid ignition sources when working with flammable materials, such as isopropanol, methanol, and other flammable solvents.

## Operational Precautions and Limitations

---

- Take care in the use and disposal of any chemicals. There is a potential risk of personal injury if proper procedures for handling and disposal of chemicals are not followed.
- Avoid skin contact with chemicals during cleaning, and wash hands after use.
- Make sure that all exhaust hoses are connected properly and that all connections are functioning as designed.
- Collect all spent liquids and dispose of them as hazardous waste.
- Comply with all of the local regulations for the storage, handling, and disposal of biohazardous, toxic, and radioactive materials.
- (Recommended) Use secondary containment trays beneath the roughing pump, the solvent bottles, and the waste container to capture potential chemical spills.

## System Safe Fluids

The following fluids can safely be used with the system. For information about safe cleaning solutions, refer to the section: [Required Materials](#).



**CAUTION:** Potential System Damage. Do not use any other fluid until confirmation is received from SCIEX that it does not present a hazard. This is not an exhaustive list.

---

**Note:** Use only new, freshly prepared LC-MS-grade or better solvents for the LC mobile phases.

---

- **Organic Solvents**
  - LC-MS-grade acetonitrile; up to 100%
  - LC-MS-grade methanol; up to 100%
  - LC-MS-grade isopropanol; up to 100%
  - LC-MS-grade or higher water; up to 100%
  - Acetonitrile; up to 100%
  - Methanol; up to 100%
  - Isopropanol; up to 100%
  - DDI water water; up to 100%
  - Tetrahydrofuran; up to 100%
  - Toluene and other aromatic solvents; up to 100%
  - Hexanes; up to 100%
- **Buffers**
  - Ammonium acetate; less than 100 mM

- Ammonium formate; less than 100 mM
- Phosphate; less than 1%
- **Acids and Bases**
  - Formic acid; less than 1%
  - Acetic acid; less than 1%
  - Trifluoroacetic acid (TFA); less than 1%
  - Heptafluorobutyric acid (HFBA); less than 1%
  - Ammonia/ammonium hydroxide; less than 1%
  - Phosphoric acid; less than 1%
  - Trimethylamine; less than 1%
  - Triethylamine; less than 1%

## Ventilation Precautions

The venting of fumes and disposal of waste must comply with all of the federal, state, provincial, and local health and safety regulations. It is the responsibility of the customer to make sure that the air quality is maintained in compliance with local health and safety regulations.

The source exhaust system and roughing pump must be vented to a dedicated laboratory fume hood or an external exhaust system.



**WARNING! Fire Hazard. Make sure that the source exhaust system is connected and functioning, to prevent flammable vapor from accumulating in the ion source.**

---



**WARNING! Ionizing Radiation Hazard, Biohazard, or Toxic Chemical Hazard. Take care to vent exhaust gases to a dedicated laboratory fume hood or exhaust system and make sure that the ventilation tubing is secured with clamps. Make sure that the laboratory has appropriate air exchange for the work performed.**

---



**WARNING! Ionizing Radiation Hazard, Biohazard, or Toxic Chemical Hazard. Do not operate the mass spectrometer if the source exhaust drain and roughing pump exhaust hoses are not properly connected to the laboratory ventilation system. Examine the exhaust tubing regularly to make sure that there are no leaks. The use of mass spectrometers without proper system ventilation might constitute a health hazard and might result in serious injury.**

---

## Operational Precautions and Limitations

---



**WARNING!** Ionizing Radiation Hazard, Biohazard, or Toxic Chemical Hazard. Do not use the ion source without knowledge of and training in the proper use, containment, and evacuation of toxic or injurious materials used with the ion source.

---



**WARNING!** Puncture Hazard, Ionizing Radiation Hazard, Biohazard, or Toxic Chemical Hazard. Discontinue use of the ion source if the ion source window is cracked or broken, and then contact a SCIEX Field Service Employee (FSE). Any toxic or injurious materials introduced in the equipment will be present in the source exhaust output. Exhaust from equipment should be vented from the room. Dispose of sharps following established laboratory safety procedures.

---

## Physical Precautions

---



**WARNING!** Lifting Hazard. Use a mechanical lifting device to lift and move the mass spectrometer. Follow established safe lifting procedures. We recommend the use of a professional moving service. For the weights of system components, refer to the document: *Site Planning Guide*.

---

## Environmental Precautions

Use qualified personnel for the installation of electrical mains, heating, ventilation, and plumbing supplies and fixtures. Make sure that all of the installations comply with local bylaws and biohazard regulations. For information about the required environmental conditions for the system, refer to the document: *Site Planning Guide*.

Allow access space around the equipment when setting up the system.



**DANGER!** Explosion Hazard. Do not operate the system in an environment containing explosive gases. The system is not designed for operation in an explosive environment.

---



**WARNING!** Biohazard. For biohazardous material use, always comply with local regulations for hazard assessment, control, and handling. This system or any part is not intended to act as a biological containment.

---



**WARNING!** Environmental Hazard. Follow established procedures for disposal of biohazardous, toxic, radioactive, and electronic waste. The customer is responsible for disposal of hazardous substances, including chemicals, waste oils, and electrical components, in accordance with local laws and regulations.

---

**CAUTION: Potential Mass Shift. Maintain a stable ambient temperature. If the temperature changes by more than 2 °C per hour, then the resolution and mass calibration might be affected.**

---

## Electromagnetic Environment

### Electromagnetic Compatibility

**Basic Electromagnetic Environment:** Environment existing at locations characterized by being supplied directly at low voltage from the public mains network.

**Performance Criteria A (Criteria A):** Equipment shall operate as intended with no degradation of performance and no loss of function during or after test.

**Performance Criteria B (Criteria B):** Equipment may experience loss of function (one or more) during test but shall operate as intended with some degradation of performance and functions self-recoverable after test.

**Performance Criteria C (Criteria C):** Equipment may experience loss of function (one or more) during test but shall operate as intended with some degradation of performance and functions recoverable by operator after test.

The equipment is intended for use in a basic electromagnetic environment.

The expected performance loss under the electromagnetic immunity conditions is less than 20% change in total ion count (TIC).

Make sure that a compatible electromagnetic environment for the equipment can be maintained so that the device will operate as intended. If the power supply line is subject to high electrical noise, then install a surge protector.

### Electromagnetic Interference

**Group 1 Equipment:** This equipment is classified as industrial, scientific, and medical (ISM) equipment that might use RF energy for internal operation.

**Class A Equipment:** Equipment which is suitable for use in all establishments other than domestic and those directly connected to a low voltage power supply network which supplies buildings used for domestic purposes. [Derived from CISPR 11:2009, 5.3] Class A equipment shall meet Class A limits.

---

**CAUTION: Potential Radio Interference. This equipment is not intended for use in residential environments and may not provide adequate protection to radio reception in such environments.**

---

This equipment has been tested and found to comply with the limits for a Class A digital device, pursuant to Part 15 of the FCC (Federal Communications Commission) Compliance Rules.

## Operational Precautions and Limitations

---

These limits are designed to provide reasonable protection against harmful interference when the equipment is operated in a commercial environment. This equipment generates, uses, and can radiate radio frequency energy and, if not installed and used in accordance with the operator's manual, can cause harmful interference to radio communications.

Operation of this equipment in a residential area is likely to cause harmful interference in which case you will be required to correct the interference, at your own expense. Changes or modifications not expressly approved by the manufacturer could void your authority to operate the equipment.

## Decommissioning and Disposal

---



**WARNING! Environmental Hazard. Follow established procedures for disposal of biohazardous, toxic, radioactive, and electronic waste. The customer is responsible for disposal of hazardous substances, including chemicals, waste oils, and electrical components, in accordance with local laws and regulations.**

---

Before decommissioning, decontaminate the entire system following local regulations.

When removing the system from service, separate and recycle different materials according to national and local environmental regulations. Refer to the section: [Storage and Handling](#).

---

**Note:** SCIEX will not accept any system returns without a completed Decontamination Form. Contact an FSE to obtain a copy of the form.

---

Do not dispose of system components or subassemblies, including computer parts, as unsorted municipal waste.

## Waste Electrical and Electronic Equipment

Follow local municipal waste ordinances for proper disposal provisions to reduce the environmental impact of waste, electrical, and electronic equipment (WEEE). To safely dispose of this equipment, contact a local Customer Service office for complimentary equipment pick-up and recycling.

## Qualified Personnel

Only qualified SCIEX personnel shall install, inspect, and service the equipment. After installing the system, the Field Service Employee (FSE) uses the *Customer Familiarization Checklist* to orient the customer on system operation, cleaning, and basic maintenance. SCIEX might not cover the damage to a system under warranty if it is serviced by personnel not authorized by SCIEX.

Only personnel qualified by the manufacturer shall maintain the equipment. A laboratory designate can be familiarized with the Qualified Maintenance Person (QMP) procedures during



the installation. A QMP is a person who is suitably aware of the electrical and chemical risks associated with servicing laboratory equipment.

## Laboratory Conditions

### Safe Environmental Conditions

The system is designed to operate safely under these conditions:

- Indoors
- Altitude: Up to 2,000 m (6,560 ft) above sea level
- Ambient temperature: 5 °C (41 °F) to 40 °C (104 °F)
- Relative humidity: 20% to 80%, non-condensing
- Mains supply voltage fluctuations:  $\pm 10\%$  of the nominal voltage
- Transient overvoltages: Up to the levels of Overvoltage Category II
- Temporary overvoltages on the mains supply
- Pollution Degree 2

### Performance Specifications

The system is designed to meet specifications under these conditions:

- An ambient temperature of 15 °C to 26 °C (59 °F to 78.8 °F)

Over time, the temperature must remain within a range of 4 °C (7.2 °F), with the rate of the change in temperature not exceeding 2 °C (3.6 °F) per hour. Ambient temperature fluctuations exceeding the limits might result in mass shifts in spectra.

- Relative humidity from 20% to 80%, non-condensing

## Equipment Use and Modification



**WARNING! Personal Injury Hazard. Contact the SCIEX representative if product installation, adjustment, or relocation is required.**

---



**WARNING! Electrical Shock Hazard. Do not remove the covers. Removing the covers might cause injury or malfunctioning of the system. The covers need not be removed for routine maintenance, inspection, or adjustment. Contact a SCIEX Field Service Employee (FSE) for repairs that require the covers to be removed.**

---

## Operational Precautions and Limitations

---



**WARNING! Personal Injury Hazard. Use SCIEX-recommended parts only. Use of parts not recommended by SCIEX or use of parts for any purpose other than their intended purpose can put the user at risk of harm or negatively impact system performance.**

---



**WARNING! Lifting Hazard. Use a mechanical lifting device to lift and move the mass spectrometer. Follow established safe lifting procedures. We recommend the use of a professional moving service. For the weights of system components, refer to the document: *Site Planning Guide*.**

---



**WARNING! Crushing Hazard. Wear protective footwear when moving heavy objects.**

---

Use the system indoors in a laboratory that complies with the environmental conditions recommended in the mass spectrometer document: *Site Planning Guide*.

If the system is used in an environment or in a manner not prescribed by the manufacturer, then the performance and protection provided by the equipment might be impaired.

Unauthorized modification or operation of the system might cause personal injury and equipment damage, and might void the warranty. Erroneous data might be generated if the system is operated outside the recommended environmental conditions or with unauthorized modifications. Contact an FSE for information on servicing the system.

The system is designed for the qualitative and quantitative analysis of chemical species.

This section includes information about the mass spectrometer. For an overview of the ion source, refer to the document: *DuoSpray Ion Source Operator Guide*.

For information on the computer and software, refer to the document: *Software Installation Guide* for the software.

## System Overview

The TripleTOF 6600+ system includes the following components:

- A TripleTOF 6600+ mass spectrometer with a roughing pump.
- A DuoSpray ion source. Refer to the document: *DuoSpray Ion Source Operator Guide*.
- A SCIEX-supplied computer and monitor with the Analyst TF software for instrument optimization, acquisition method development, and data acquisition. For computer specifications and requirements, refer to the document: *Software Installation Guide* for the Analyst TF software.
- The optional calibrant delivery system (CDS)

## Hardware Overview

[Figure 2-1](#) and [Figure 2-2](#) show the mass spectrometer components and connections.

## Principles of Operation

Figure 2-1 Front and Right Side View

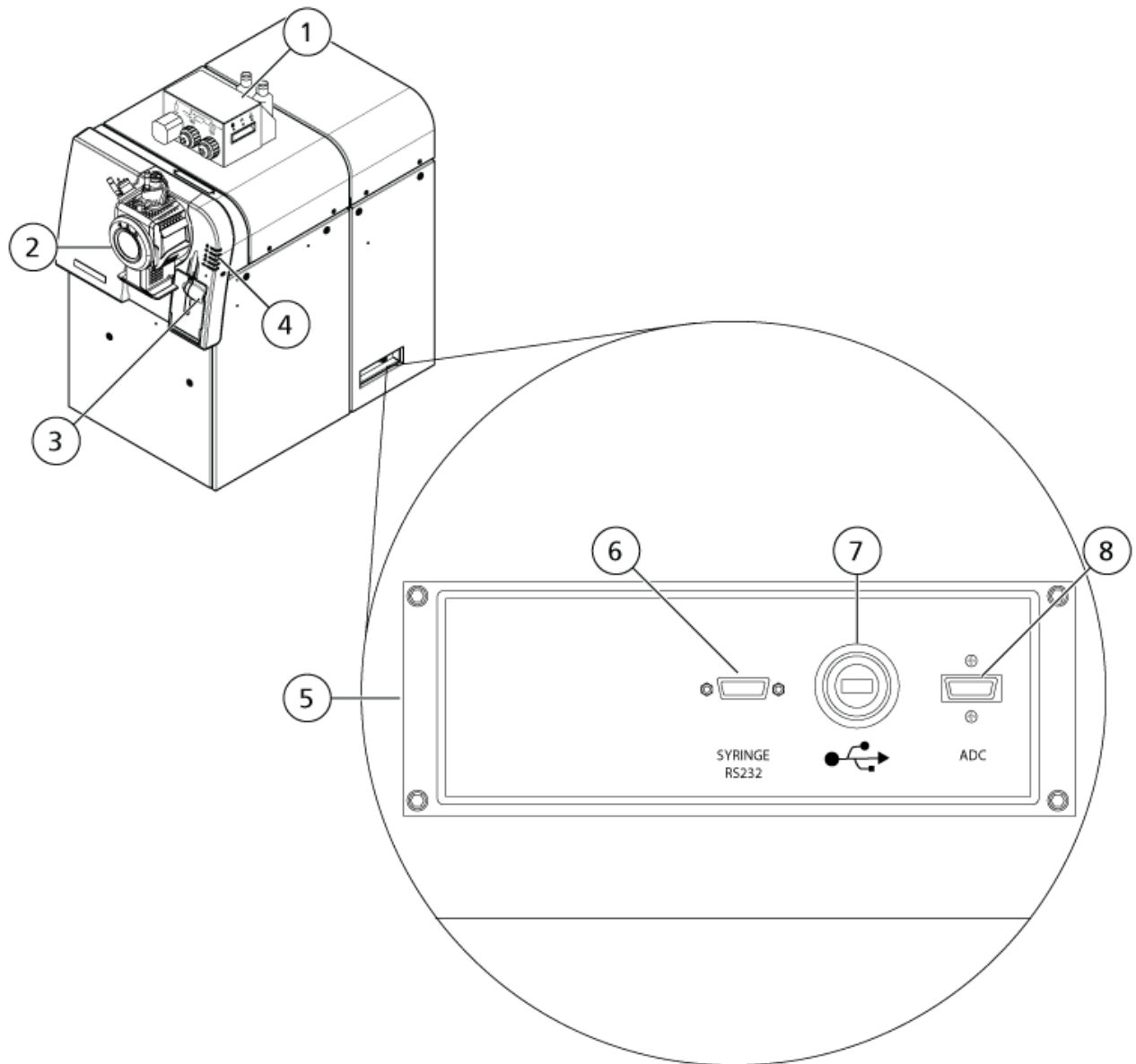

Item	Description	For more information...
1	Optional CDS	Refer to the <i>CDS Operator Guide</i> .
2	DuoSpray ion source	Refer to the <i>DuoSpray Ion Source for TripleTOF Systems Operator Guide</i> .

---

Item	Description	For more information...
3	Syringe pump	Refer to <a href="#">Adjust the Integrated Syringe Pump Position</a> .
4	Mass spectrometer status LEDs	Refer to <a href="#">Panel Symbols</a> .
5	Communications bulkhead	Contact an SCIEX Field Service Employee (FSE).
6	Serial (RS-232) cable connection for the syringe pump	Contact an FSE.
7	USB cable connection for the USB-GPIB card	Contact an FSE.
8	InfiniBand cable connection for the ADC card	Contact an FSE.

## Principles of Operation

Figure 2-2 Left Side View

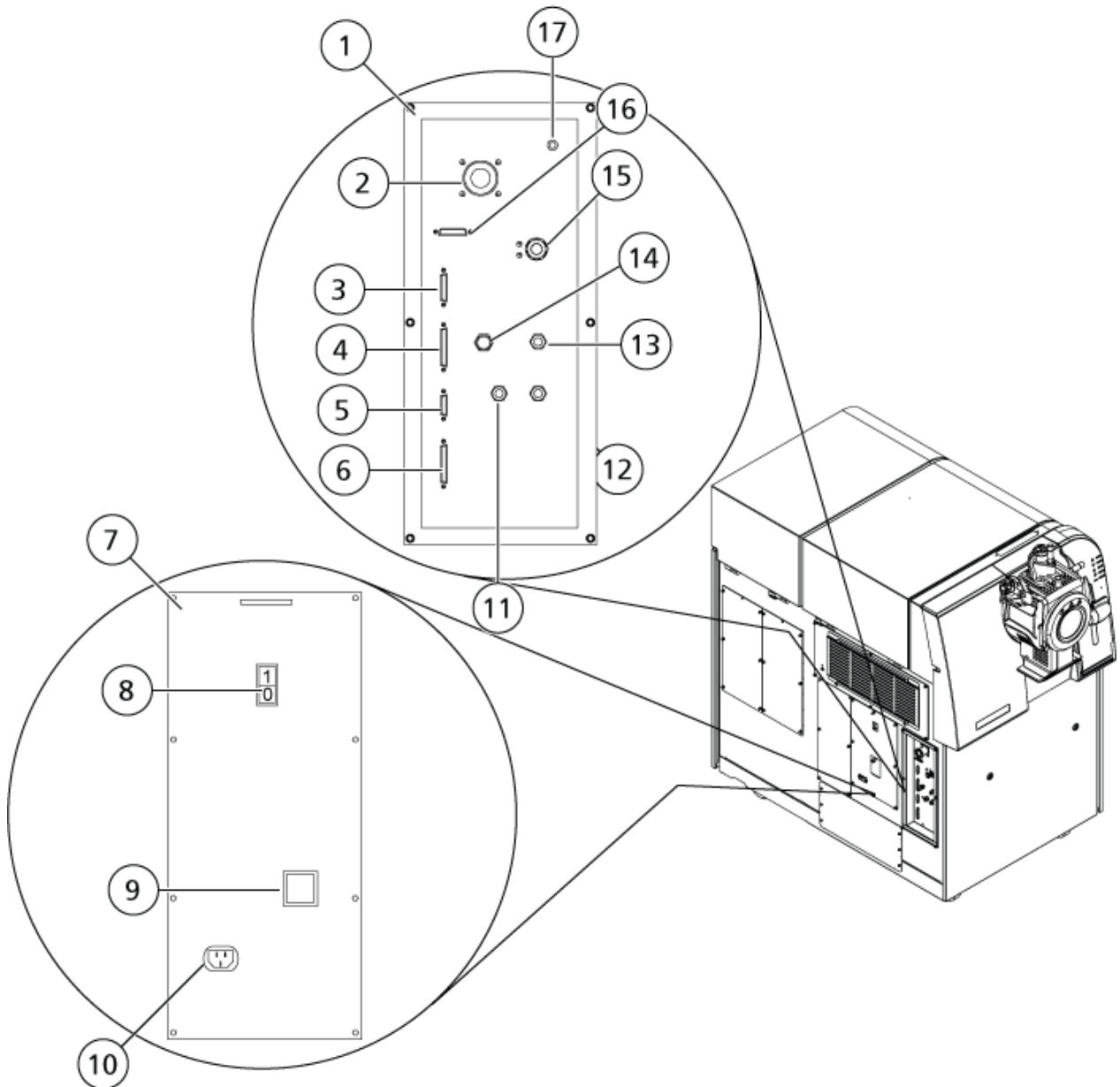

Item	Description	For more information...
1	Gas and vacuum bulkhead	Contact an FSE.
2	Roughing pump vacuum connection	Contact an FSE.
3	Calibrant control connection	Refer to the <i>CDS Operator Guide</i> .

Item	Description	For more information...
4	AUX IO connection. The optional LC system start signal connects to this port.	Contact an FSE.
5	External control connection. This port is intended for future use.	Contact an FSE.
6	Sources connection. Some ion sources connect to this port.	Contact an FSE.
7	AC distribution panel	Contact an FSE.
8	Instrument power switch	Refer to <a href="#">Start Up the System</a> .
9	Cover over circuit breaker	Refer to <a href="#">Start Up the System</a> . Use the power switch rather than the circuit breaker to shut down the system.
10	Mains supply connection	Refer to <a href="#">Start Up the System</a> .
11	Curtain Gas (nitrogen) supply connection	Contact an FSE.
12	Gas 1 and Gas 2 (zero) supply connection	Contact an FSE.
13	Source exhaust gas (zero air or nitrogen) supply connection	Contact an FSE.
14	CAD gas (nitrogen) supply connection	Contact an FSE.
15	Source exhaust waste connection	Contact an FSE.
16	Not used	N/A.
17	Not used	N/A.







## Panel Symbols

The following table describes the mass spectrometer status LEDs.

## Principles of Operation

---

**Table 2-1 Panel Symbols**

LED	Color	Name	Description
	Green	Power	Illuminated when the system is powered up.
	Green	Vacuum	Illuminated when the operating vacuum level has been achieved. Flashing if the vacuum is not at the correct level, that is, during pump down and venting.
	Green	Ready	Illuminated when the system is in the Ready state. The system must be in the Ready state to operate.
	Blue	Scanning	Flashing when the system is acquiring data.
	Red	Fault	Illuminated when the system encounters a system fault.
	Green	Syringe Pump Status	Illuminated when the syringe pump is running.

After the system is turned on, all of the LEDs illuminate. The power LED remains illuminated. The other LEDs flash for two seconds and then turn off. The vacuum LED starts flashing. After the operating vacuum level is achieved, this LED remains illuminated.

## Theory of Operation

Mass spectrometry measures the mass-to-charge ratio of ions to identify unknown compounds, to quantify known compounds, and to provide information about the structural and chemical properties of molecules.

The TripleTOF 6600+ system has a series of quadrupole filters that select or transmit ions according to their mass-to-charge ratio ( $m/z$ ). The first quadrupole in this series is the QJet ion guide, which is located between the orifice plate and the Q0 region. The QJet ion guide does not filter ions, but focuses them before they enter the Q0 region. By prefocusing the larger ion flux created by the wider orifice, the QJet ion guide increases instrument sensitivity and improves the signal-to-noise ratio. In the Q0 region, the ions are further focused before passing into the Q1 quadrupole.

The Q1 quadrupole sorts the ions before they enter the Q2 collision cell. The Q1 quadrupole works in two operational modes:



- Passing all ions within a specified  $m/z$  range to the Q2 collision cell. This is a TOF MS scan. All ions are analyzed by the system.
- Passing one ion with a specified  $m/z$  ratio to the Q2 collision cell. This is a TOF MS/MS scan. Only the selected ion is analyzed.

In the Q2 collision cell, the internal energy of the ions is increased through collisions with gas molecules to the point that molecular bonds break, creating product ions. This technique allows users to design experiments that measure the  $m/z$  ratio of product ions to determine the composition of the parent ions and to provide information about the structural and chemical properties of the molecules.

After passing through the Q2 collision cell, the ions enter the TOF region for additional mass analysis. They reach the detector at different times depending on their  $m/z$  ratio. In the detector, the ions create a current that is converted into a voltage pulse. These voltage pulses are counted and the number of pulses is directly proportional to the quantity of ions entering the detector. The mass spectrometer converts the voltage pulses to a signal and then correlates the signal to the time it takes each ion to reach the detector. The signal represents the ion intensity and the time to reach the detector represents a specific  $m/z$  value. The mass spectrometer shows this data as a mass spectrum.

## Data Handling

The Analyst TF software requires a computer running the Windows 7, 64-bit or Windows 10, 64-bit operating system. The computer and the associated system software work with the system controller and the associated firmware to control the system and data acquisition. During system operation, the acquired data is sent to the Analyst TF software where it can be shown as either full mass spectra, an ion chromatogram or ion spectra, or total ion current over time.



**WARNING! Personal Injury Hazard.** Follow the instructions in the documentation when using the system. The protection provided by the equipment might be impaired if the equipment is used in a manner not specified by SCIEX.

---

## Start Up the System



**WARNING! Electrical Shock Hazard.** Make sure that the system can be disconnected from the mains supply outlet in an emergency. Do not block the mains supply outlet.

---



**WARNING! Lifting Hazard.** Do not move the system without consulting a Field Service Employee (FSE). Risk of personal injury or system damage. If the system must be moved, then contact an FSE.

---

**Note:** Before operating the instrument, read the safety information in the section: [Operational Precautions and Limitations](#).

---

### Prerequisites

- The site requirements specified in the *Site Planning Guide* are met. The *Site Planning Guide* includes information on the mains supply and connections, compressed air, nitrogen, roughing pump, ventilation, exhaust, and site clearance requirements. Contact SCIEX for a copy of the *Site Planning Guide*, if required. For contact information, go to [sciex.com/contact-us](http://sciex.com/contact-us).
- The source exhaust gas, compressed air, and nitrogen gases are connected to the mass spectrometer.
- The 4 L source exhaust drain bottle is connected to the exhaust waste connection on the back of the mass spectrometer and to the laboratory ventilation system.
- The source exhaust hoses are securely clamped at the mass spectrometer, source exhaust drain bottle, and ventilation connections.
- The instrument power switch is turned off and the mains supply cable is plugged in the mass spectrometer.
- The mass spectrometer and roughing pump mains supply cables are connected to the 200 VAC to 240 VAC mains supply.
- The Ethernet cable is connected to both the mass spectrometer and the computer.

1. Turn on the roughing pump.
2. Remove the cover on the circuit breaker switch on the left side of the mass spectrometer, when viewed from the front, and then turn on the circuit breaker. Refer to [Figure 2-2](#).
3. Replace the cover over the circuit breaker switch, and then tighten the screw holding the cover until it is finger tight.
4. Turn on the instrument power switch. Refer to [Figure 2-2](#).
5. Turn on the computer.
6. Open the control software.

## Shut Down the System

Some procedures require that the system be shut down. Others require that it also be vented. Follow these steps to shut down and, if required, vent the system.

**Note:** If the gas tubing must be disconnected, then relieve the pressure in the gas lines before disconnecting it.

## Operating Instructions

---

**Tip!** If the mass spectrometer will not be used for an extended period, then leave it in Standby state with the ion source in place. If the mass spectrometer must be shut down, then follow these instructions.

---

1. Complete or stop any ongoing scans.
- 

**CAUTION: Potential System Damage. Turn off the sample flow before shutting down the system.**

---

2. Turn off the sample flow to the system.
  3. In the Analyst TF software, deactivate the hardware profile, if it is active.
  4. Close the software.
  5. Turn off the instrument power switch on the left side of the instrument. Refer to [Hardware Overview](#).
  6. (If required) Follow these steps to vent the system:
- 

**Note:** Leave the ion source installed for proper venting.

---

- a. Turn off the roughing pump.
  - b. Wait for the system to vent. This takes 15 minutes to 25 minutes.
7. Remove the cover on the circuit breaker switch on the left side of the mass spectrometer and then turn off the circuit breaker. Refer to [Figure 2-2](#).
  8. Install the cover over the circuit breaker switch and then tighten the screw that secures the cover until it is finger tight.
  9. (If venting the system) Disconnect the roughing pump mains supply cable from the mains supply outlet.

## Adjust the Integrated Syringe Pump Position

---



**WARNING! Puncture Hazard. Take care when handling the syringe. The tip of the syringe is extremely sharp.**

---



**WARNING! Puncture Hazard. Make sure that the syringe is seated properly in the syringe pump and that the automatic syringe pump stop is adjusted properly to avoid damaging or breaking the glass syringe. If the syringe breaks, follow established safety procedures for sharps disposal.**

---

For the location of the syringe pump on the mass spectrometer, refer to the figure: [Figure 2-1](#).

1. Press the Release button on the right side of the syringe pump to lower the base and then insert the syringe.

**Figure 3-1 Lowering the Syringe**

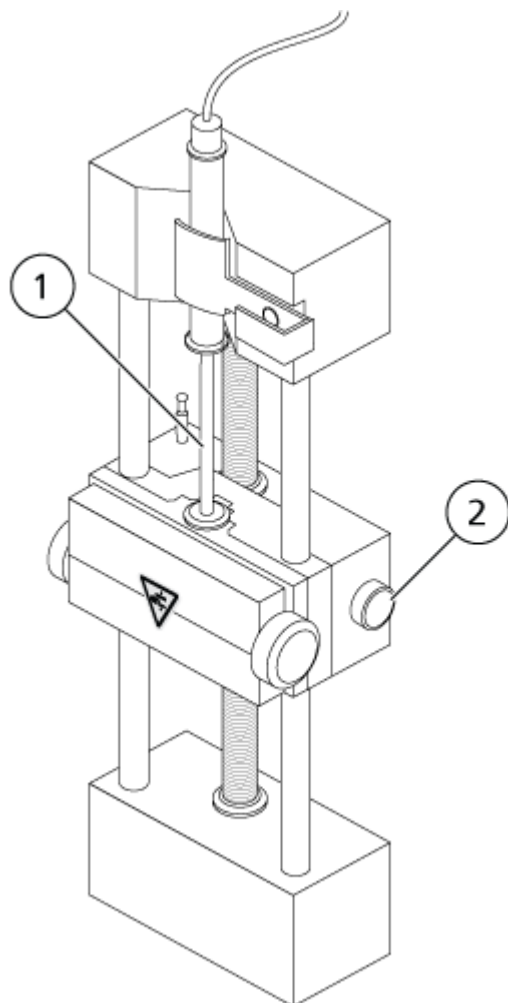

Item	Description
1	Syringe plunger
2	Release button. Press to raise or lower the base.

2. Make sure that the end of the syringe is flush with the base and that the shaft of the syringe rests in the cutout.
3. Adjust the post so that it triggers the automatic syringe stop before the syringe plunger hits the bottom of the glass syringe.

**Figure 3-2 Automatic Syringe Stop**

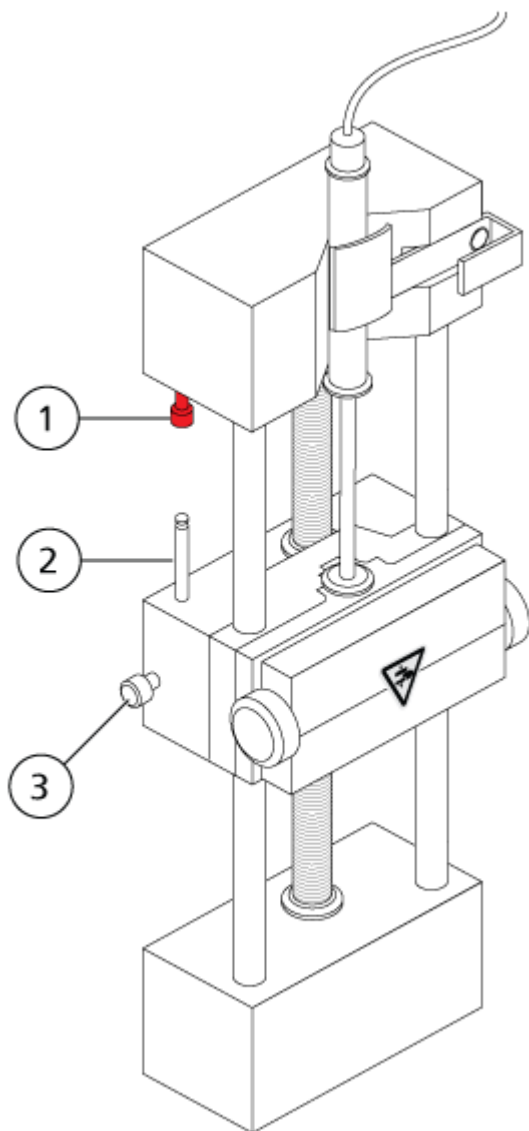

Item	Description
1	Automatic syringe stop. After the post hits the automatic syringe stop, the syringe pump stops.
2	Post. Adjust the height to prevent the syringe plunger from hitting the syringe during sample infusion.
3	Post lock screw. Tighten the screw after the height of the post is adjusted.

4. Turn the syringe pump screws to secure the syringe.

**Figure 3-3 Syringe Pump Screws**

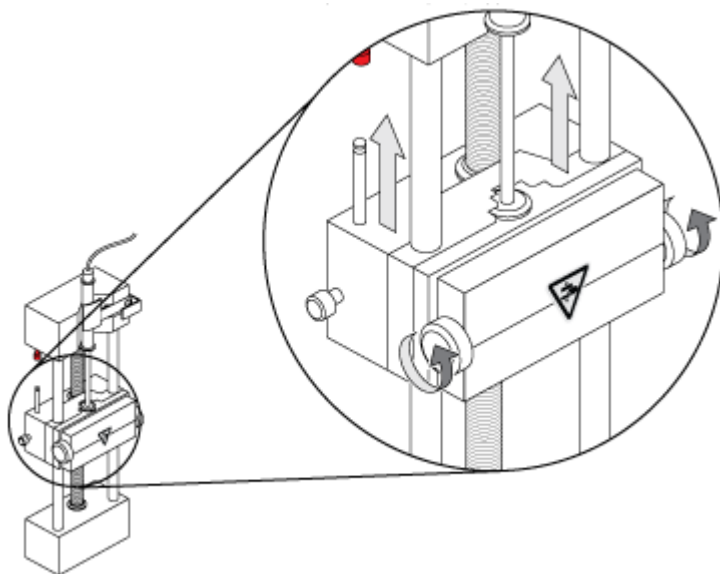

5. Make sure that the mass spectrometer and integrated syringe pump are activated in the software.
6. In the Analyst TF software, on the Navigation bar, double-click **Manual Tuning**.
7. Click **Start Syringe**.
8. To stop the syringe pump, click **Stop Syringe**.

## Reset the Syringe Pump

If the Analyst TF software stops communicating with the syringe pump, then reset the syringe pump.

Use a paper clip or similar tool to press the reset button, shown in [Figure 3-4](#).

Figure 3-4 Reset Button

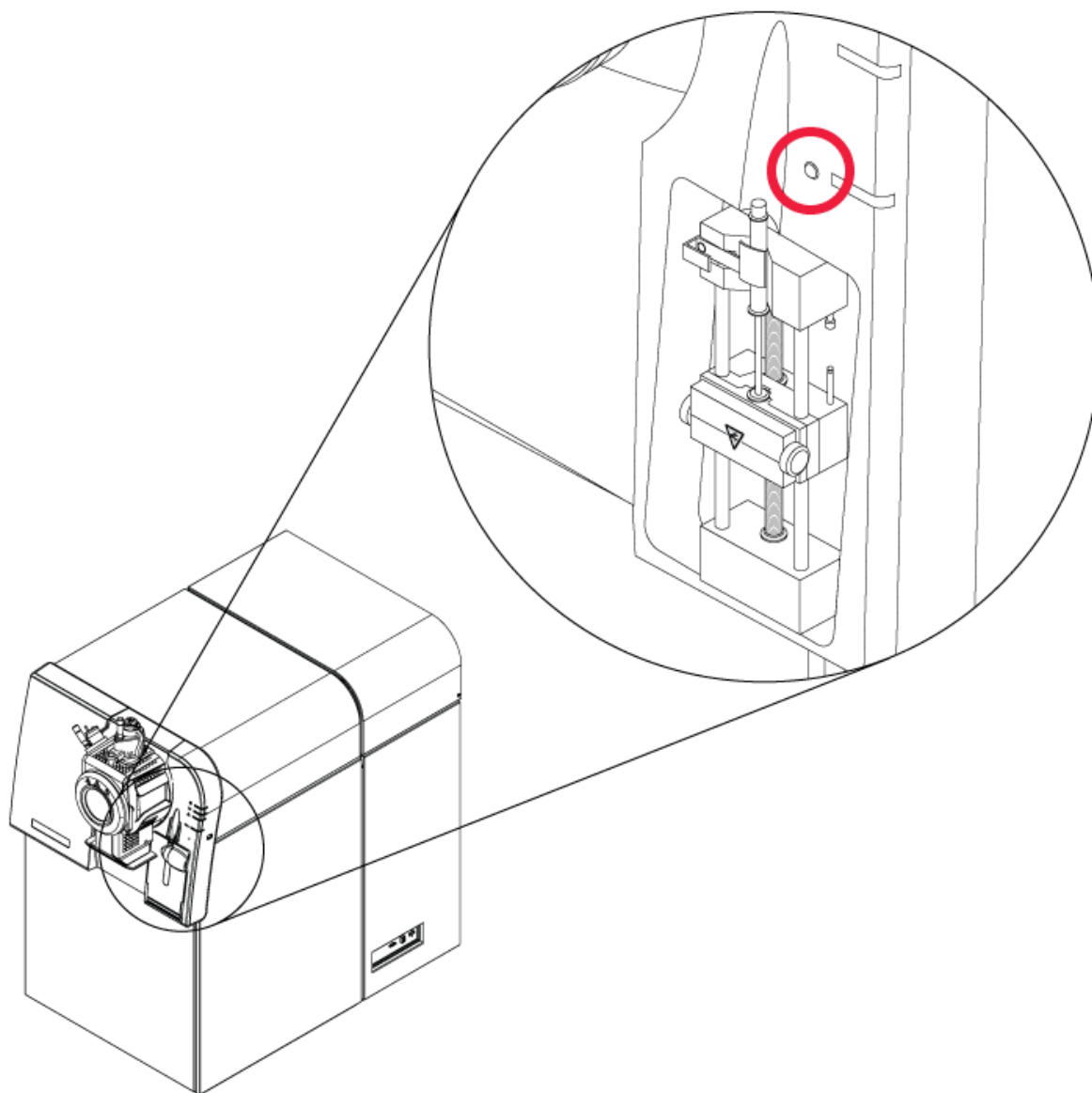



# Operating Instructions — Sample Workflows

# 4

Table 4-1 Instrument Setup

Step	To do this...	Find the information in....	What does it do?
1	Create a hardware profile.	<a href="#">Create a Hardware Profile</a>	Each hardware profile must include a mass spectrometer and other devices, such as an LC system. Only devices included in the active hardware profile can be used when creating acquisition methods.
2	Create projects to store data.	<a href="#">Create Projects and Subprojects</a>	Using projects and subprojects facilitates data management and makes comparison of results easier.
3	Optimize the mass spectrometer.	<a href="#">Optimize the Mass Spectrometer</a>	This is the process of optimizing the resolution and mass spectrometer parameters, and calibrating the mass spectrometer to obtain the best sensitivity and performance from the system.

**Table 4-2 Sample Acquisition Workflow**

Step	To do this...	Find the information in....	What does it do?
1	Create projects to store data.	<a href="#">Create Projects and Subprojects</a>	Before starting an experiment, decide where to store the files related to the experiment. Using projects and subprojects improves data management and makes comparison of results easier.
2	Create an acquisition method.	<a href="#">Operating Instructions — Acquisition Methods</a>	To analyze samples, create an acquisition method for the mass spectrometer and any LC devices. An acquisition method indicates which peripheral devices to use, when to use them to acquire data, and the associated parameters.
3	Create and submit a batch.	<a href="#">Add Sets and Samples to a Batch and Submit a Sample or Set of Samples</a>	After creating an acquisition method, run samples by creating an acquisition batch and submitting the batch to the acquisition queue.

Table 4-2 Sample Acquisition Workflow (continued)

Step	To do this...	Find the information in....	What does it do?
4	Run samples to acquire data.	<a href="#">Acquire Data</a>	Running samples involves managing the acquisition queue and monitoring instrument and device status. To submit samples and acquire data, use the Queue Manager. The Queue Manager shows queue, batch, and sample status, and facilitates management of samples and batches in the queue.
5	Analyze data in Explore mode.  —OR—	<a href="#">Operating Instructions — Analyze and Explore Data</a>	In Explore mode, many tools are available for viewing and processing the acquired data. Graphs can be customized with peak labels and captions, contour plots can be shown, and spectra can be saved in the library.
6	Analyze data and print reports using companion software.	MultiQuant software/PeakView software	Use the MultiQuant software or PeakView software to analyze data. For more information, refer to the documentation that comes with the software.

**Table 4-3 Experienced User Workflow**

<b>Step</b>	<b>To do this...</b>	<b>Find the information in....</b>
1	Mass calibrate the instrument.	Mass Calibration Tutorial located in <ul style="list-style-type: none"><li>• On Windows 7 operating systems: Click <b>Start &gt; All Program &gt; SCIEX &gt; Analyst TF &gt; Software Guides.</b></li><li>• On Windows 10 operating systems: Click <b>Start &gt; SCIEX Analyst TF &gt; Analyst TF Documentation,</b> and then double-click the <b>Software Guides</b> folder.</li></ul>
2	Optimize the mass spectrometer.	Manual Optimization Tutorial located in <ul style="list-style-type: none"><li>• On Windows 7 operating systems: Click <b>Start &gt; All Program &gt; SCIEX &gt; Analyst TF &gt; Software Guides.</b></li><li>• On Windows 10 operating systems: Click <b>Start &gt; SCIEX Analyst TF &gt; Analyst TF Documentation,</b> and then double-click the <b>Software Guides</b> folder.</li></ul>

# Operating Instructions — Hardware Profiles and Projects

---

# 5

## Hardware Profiles

A hardware profile tells the software how the mass spectrometer and the devices are configured and connected to the computer. Multiple hardware profiles can be configured, but only one profile can be active at any time.

When a hardware profile is created in the Hardware Configuration Editor, the peripheral devices must be configured so that the software can communicate with them. Configuring the peripheral devices requires two procedures:

- Making the physical connections. For information about making the physical connections to the devices, refer to the document: *Peripheral Devices Setup Guide*.
- Configuring the software to communicate with the peripheral devices. For a list of the supported devices, refer to the document: *Software Installation Guide* for the Analyst TF software.

When the software is installed, the driver required for each peripheral device is also installed. After the peripheral devices are physically connected to the computer, configure the appropriate configuration information.

Each hardware profile must include a mass spectrometer. Before creating an acquisition method, make sure that all of the devices to be used in the method are included in the hardware profile, including the syringe pump. The devices configured in the active hardware profile and selected in the Add/Remove Device Method dialog are shown as icons in the Acquisition method pane. Only peripheral devices included in the active hardware profile can be used in acquisition methods.

## Create a Hardware Profile

The user can create multiple hardware profiles, but only one profile can be active at any time.

1. On the Navigation bar, under **Configure**, double-click **Hardware Configuration**.

Figure 5-1 Hardware Configuration Editor Dialog

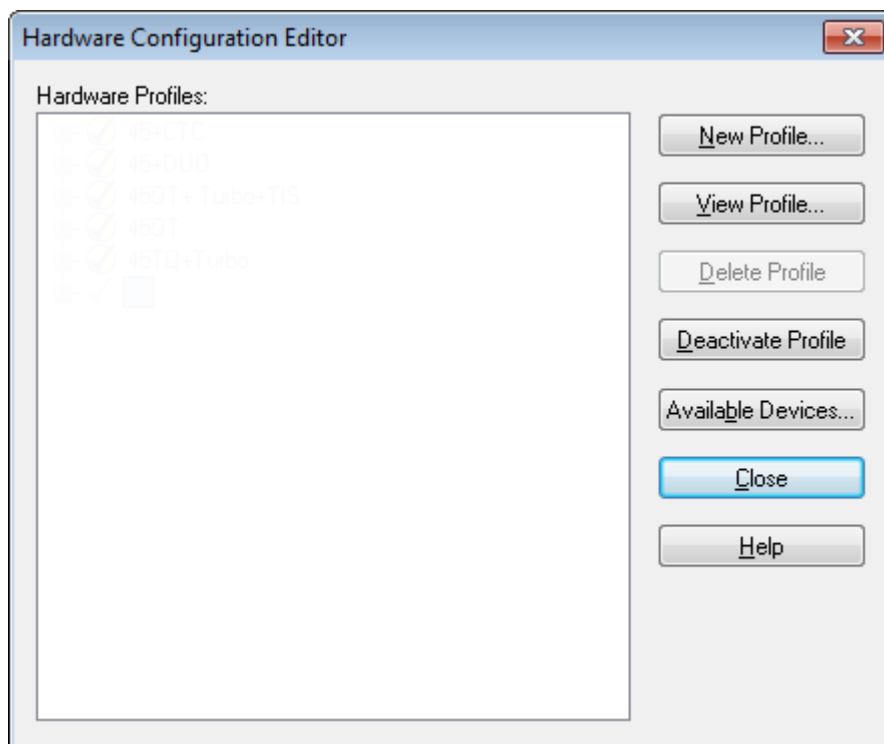

2. Click **New Profile**.

**Figure 5-2 Create New Hardware Profile Dialog**

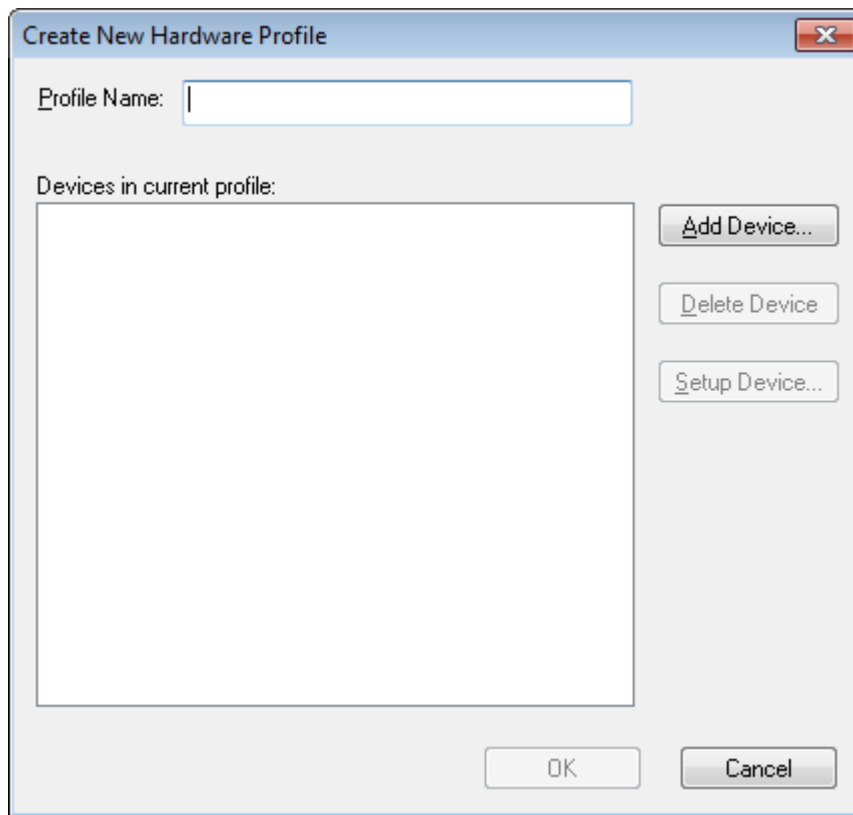

3. Type a name in the **Profile Name** field.
4. Click **Add Device**.

**Figure 5-3 Available Devices Dialog**

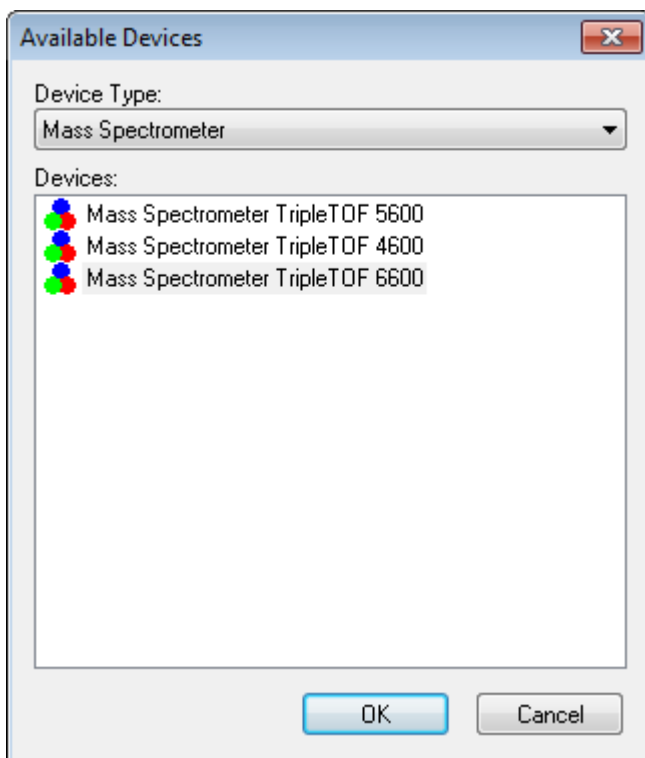

In the Available Devices dialog, **Mass Spectrometer** is the preset value for the **Device Type** field.

5. In the **Devices** list, select the appropriate mass spectrometer and then click **OK**.
6. On the Create New Hardware Profile dialog, click **Setup Device**.
7. (Optional) To configure mass spectrometers that use the integrated syringe pump, on the Configuration tab, select the **Use integrated syringe pump** check box.



**Figure 5-4 Configuration Tab with CDS and Syringe Pump Configured**

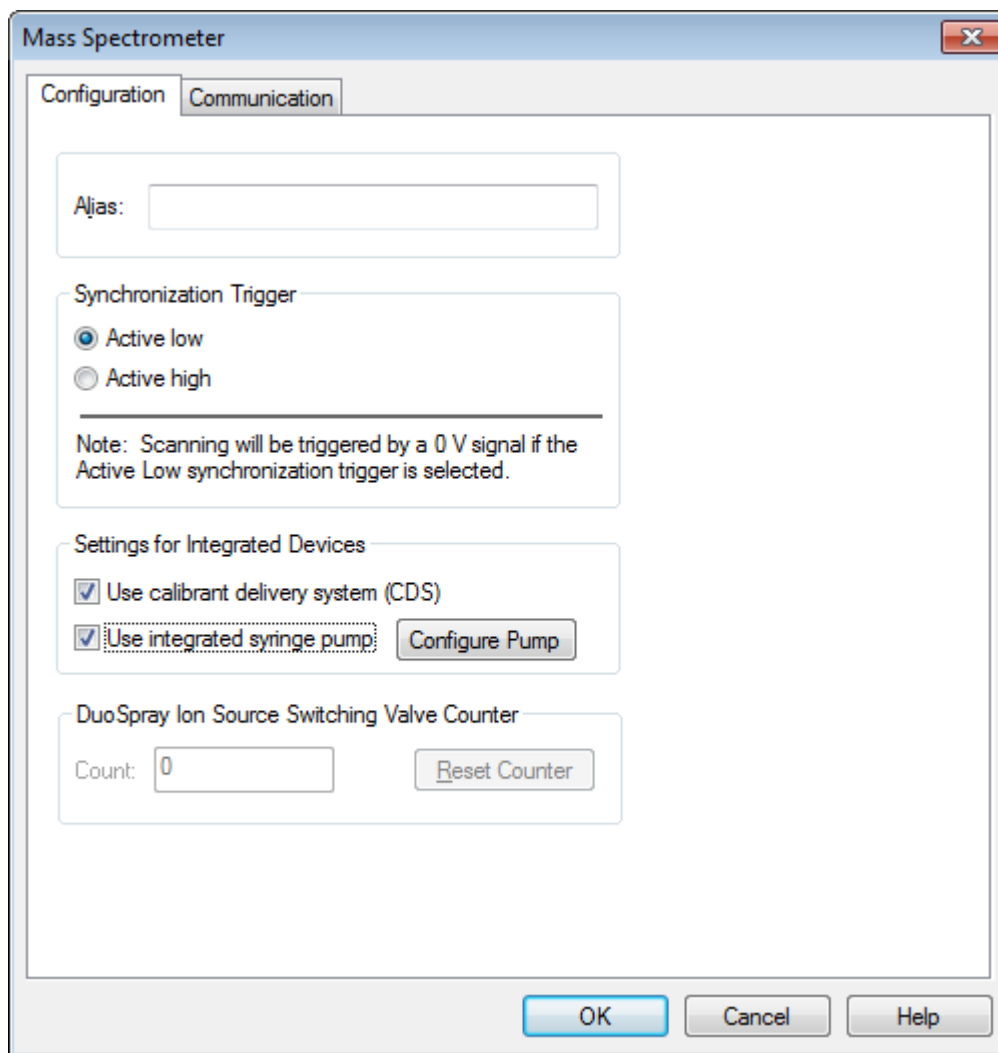

8. (Optional) To configure the mass spectrometer for the CDS, on the Configuration tab, select **Use calibrant delivery system (CDS)**.
9. (Optional) Select additional features on the Configuration and Communication tabs as required.
10. Click **OK**.
11. On the Create New Hardware Profile dialog, click **Add Device** and then add and set up each device that is used with the mass spectrometer. Refer to the section: [Add Devices to a Hardware Profile](#).
12. Click **OK** in the Create New Hardware Profile dialog.

13. Click the hardware profile to be activated in the Hardware Configuration Editor.
14. Click **Activate Profile**.  
The check mark turns green. If a red × is shown, then there is an issue with the hardware profile activation.

---

**Tip!** A hardware profile need not be deactivated before another is activated. Click a hardware profile and then click **Activate Profile**. The active profile is deactivated automatically.

---

15. Click **Close**.

## Add Devices to a Hardware Profile

Devices must be configured to enable the software to communicate with them. When the software is installed, the driver required for each device is also installed. Before devices can be configured, they must be physically connected to the computer. For more information, refer to the document: *Peripheral Devices Setup Guide*.

1. Open the Hardware Configuration Editor.
2. In the **Hardware Profiles** list, deactivate the hardware profile.
3. Click **Edit Profile**.
4. Click **Add Device**.  
The Available Devices dialog opens.
5. In the **Device Type** list, select the device and then click **OK**.

**Figure 5-5 Available Devices Dialog**

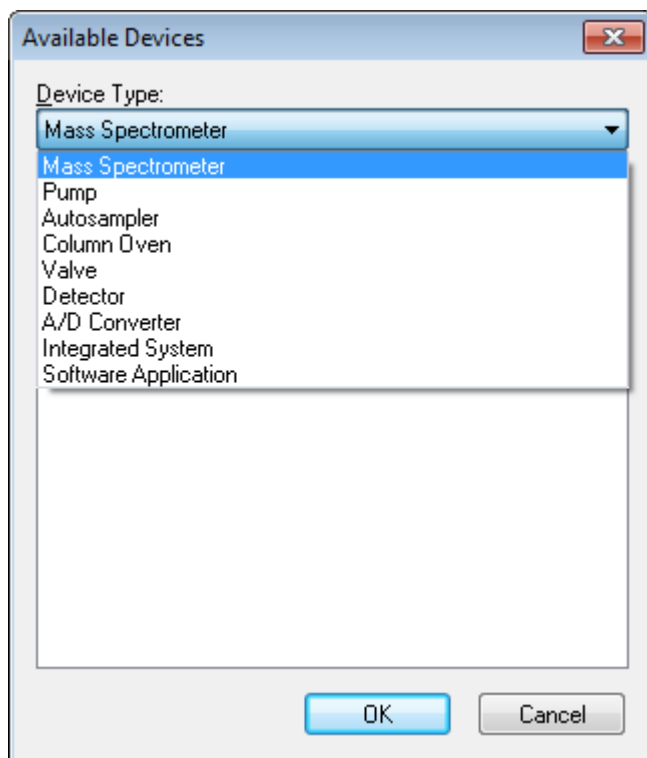

6. Click **OK**.
7. Select the device from the **Devices** list and then click **OK**.
8. Click **Setup Device**.  
A dialog containing configuration values for the device opens.
9. (Optional) On the Communication tab, in the **Alias** field, type a name or other identifier for the device.

---

**Note:** For devices using serial communication, make sure that the serial port selected matches the serial port to which the device is physically connected.

---



---

**Note:** The **Alias** field might also be referred to as the **Name** box and might be found on another tab under **Alias**.

---

- If the device uses a **Serial Port** as a communication interface, then in the **COM Port Number** list, select the COM port to which the device is connected.
- If the device uses **Ethernet** as a communication interface, then type the **IP Address** assigned to the device by the administrator or use the corresponding **Host Name** for the address.

- If the device uses **GPIB Board** as a communication interface, then do not change the settings for the GPIB board.

The rest of the preset values for the device are probably appropriate. Do not change them. For information about the Configuration and Communication tabs, refer to the Help.

10. To restore the device preset values, on the Communication tab, click **Set Defaults**.
11. To save the configuration, click **OK**.
12. Repeat step 4 to step 11 for each device.
13. Click **OK** in the Create New Hardware Profile dialog.
14. To activate the hardware profile, do this:
  - a. In the Hardware Configuration Editor, click the hardware profile.
  - b. Click **Activate Profile**.

The check mark turns green. If a red × is shown, then there is an issue with the hardware profile activation. For more information, refer to the section: [Troubleshoot Hardware Profile Activation](#).

---

**Tip!** An active hardware profile does not have to be deactivated before another one is activated. Click an inactive hardware profile and then click **Activate Profile**. The other profile is deactivated automatically.

---

15. Click **Close**.

## Troubleshoot Hardware Profile Activation

If a hardware profile fails to become active, then a dialog opens indicating which device in the profile failed to activate. A device might fail to activate because of communications errors.

1. Read the error message generated. Depending on the message, there might be an issue with a device or how the communication is set up.
2. Make sure that the device is connected to the mains supply and is turned on.
3. Make sure that the COM port assigned to the device is correct.
4. Make sure that the communication settings for the device, for example, the dual inline package (DIP) switch settings, are set correctly and match the settings on the Communication tab.
5. Turn off the device.
6. Wait 10 seconds.
7. Turn on the device.

Wait until all of the device power-up activities are complete before trying to activate the hardware profile again. Some devices might require 30 seconds or more to complete the power-up activities.

8. Activate the hardware profile.
9. If the issue persists, then delete the failing profile and create a new one.
10. If the issue still persists, then go to [sciex.com/request-support](https://sciex.com/request-support).

## Projects and Subprojects

Before beginning an experiment, decide where to store the files related to the experiment. Use projects and subprojects for each experiment to better manage data and compare results. For example, use subprojects to store the results for specific dates.

### Create Projects and Subprojects

To use a subproject structure within a project, create the subproject structure when the project is created.

1. Click **Tools > Project > Create Project**.

**Figure 5-6 Create New Project/Subproject Dialog**

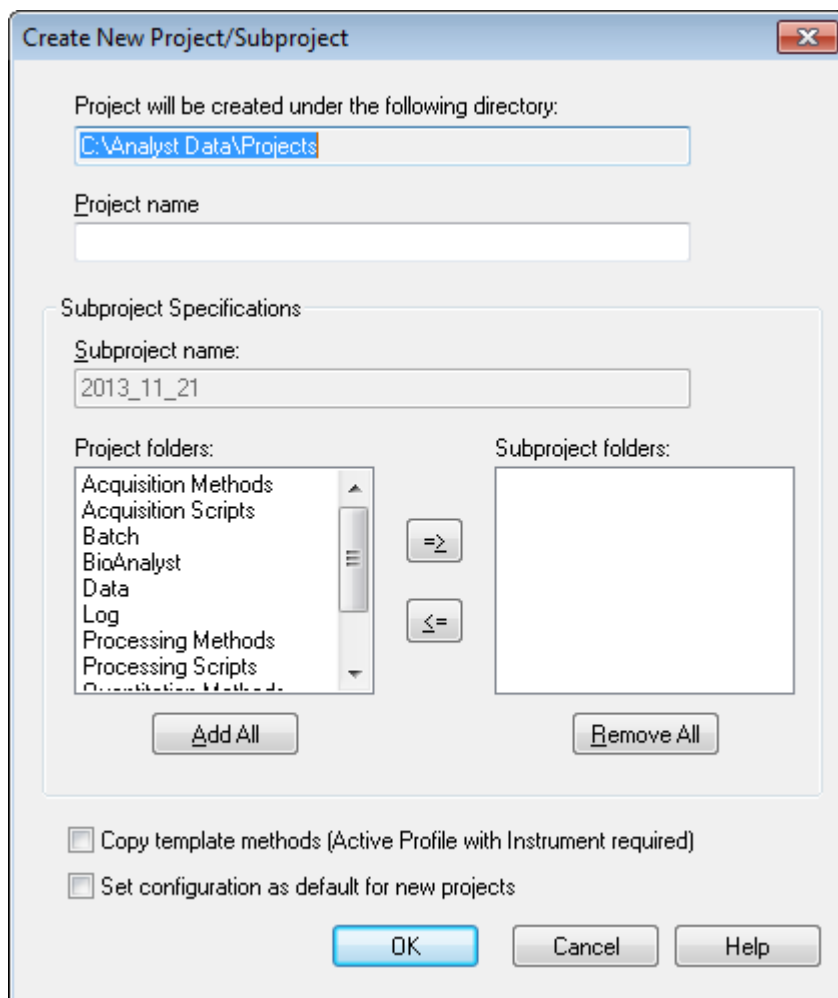

---

**Note:** A new subproject cannot be created for a project that was not originally created with a subproject.

---

2. Type a project name in the **Project name** field.
3. (Optional) To use subprojects, do this:
  - a. Select the required folders and then use the arrow buttons to move them to the **Subproject folders** list.
  - b. In the **Subproject name** field, type a name for the first subproject or use the existing date.
4. (Optional) To use this project and subproject folder organization for all new projects, select the **Set configuration as default for new projects** check box.

All new projects are created with this folder configuration.

5. Click **OK**.

### Create Subprojects

Subprojects can only be created in a project that has an existing subproject structure.

1. On the **Project** tool bar, from the **Project** list, select the project.
2. Click **Tools > Project > Create Subproject**.
3. In the **Subproject name** box, type a name for the subproject or use the existing date.
4. Click **OK**.

### Copy Subprojects

A subproject can be copied from another project that has existing subprojects. If the copied subprojects contain folders that also exist in the destination project folder, then the software uses the project level folders.

1. Click **Tools > Project > Copy Subproject**.  
The Copy Subproject dialog opens.
2. Click **Browse** to browse to the subproject source.
3. Click **OK**.
4. Select the subproject from the **Source Subproject** list.
5. Click **Browse** to browse to the subproject destination.
6. Type the name in the **Target Subproject** field.
7. Click **OK**.
8. Do one of the following:
  - To copy all folders and files from the **Subproject Source** into the **Subproject Destination**, select the **Copy Contents** check box.
  - To copy only the folders in the same structure into the **Subproject Destination**, make sure that the **Copy Contents** check box is cleared.
9. Click **Copy**.

### Change Between Projects and Subprojects

On the software tool bar, from the project list, click the required project or subproject.

**Figure 5-7 Project List**

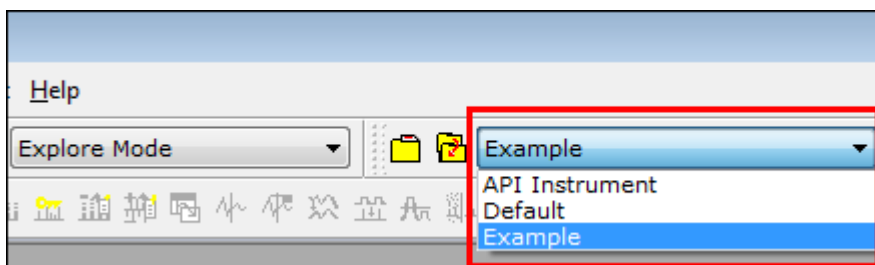

The project list in this figure shows the **API Instrument**, **Default**, and **Example** folders.

## Installed Project Folders

Three project folders are installed with the software: **API Instrument**, **Default**, and **Example**.

### API Instrument Folder

The API Instrument folder is unique and very important to the correct functioning of the mass spectrometer. The API Instrument folder contains the information required for tuning and calibrating the mass spectrometer. This information includes:

- Parameter settings files
- Reference files
- Instrument data files that contain calibration and resolution information
- Acquisition methods used during automatic tuning

The API Instrument folder also contains data files for manual tuning runs that were performed using the **Start** button rather than the **Acquire** button. These data files are saved automatically in the `API Instrument\Tuning Cache` folder and named with the date and time that they were created. The Tuning Cache folder is automatically cleared periodically.

### Default Folder

The Default folder contains folders that are present in new projects and serves as a template for new projects.

### Example Folder

The Example folder contains sample methods and data files. Users can practice working with the Explore mode using the example data files



## Back Up the API Instrument Folder

Back up the `API Instrument` folder regularly and after routine maintenance has been performed.

Copy the `API Instrument` folder, paste it to a different location, preferably on another computer, and then rename the folder. Use the date and a mass spectrometer reference when naming the folder, if there is more than one mass spectrometer. For example, `API Instrument_QT6500plus3_010121`

## Recover the API Instrument Folder

Back up the `API Instrument` folder regularly and after routine maintenance has been performed.

1. Rename the current `API Instrument` folder.
2. Copy the backup folder into the `Projects` folder.
3. Change the name of the backup folder to `API Instrument`.

# Operating Instructions — Tune and Calibrate

# 6

Run the **Verify Performance Only** option at any time. However, tune the instrument only if a loss of sensitivity or resolution is noticed. For more information about tuning and calibration, refer to the *Advanced User Guide*.

For tuning the system, use the following solutions that come with the installation kit:

For positive mode:

- For optimizing TOF MS - Product Ion High Resolution or Product Ion High Sensitivity, use the Tuning Solution.
- For Q1 calibration, use the PPG POS solution.

In negative mode:

- For optimizing TOF MS - Product Ion High Resolution or Product Ion High Sensitivity, use Taurocholic acid.

---

**Note:** We recommend that after using the Taurocholic acid, repeat the channel alignment using the PPG POS solution.

---

- For Q1 calibration, use the PPG POS solution.

---

**Tip!** Perform maintenance tasks regularly to make sure that the mass spectrometer is performing optimally.

---

Prerequisites
<ul style="list-style-type: none"><li>• The spray is stable and the correct tuning solution is being used.</li><li>• A printer is configured.</li></ul>

#### Required Materials

- Tuning solutions that are supplied in the Standards Chemical Kit shipped with the system. If required, a new kit can be ordered from SCIEX.
- Gas-tight syringe (1 mL recommended)
- Red PEEK sample tubing.
- (Optional) Syringe pump, if using a system without an integrated syringe pump.

## Optimize the Mass Spectrometer

The following procedure describes how to verify the performance of the mass spectrometer. For more information about using the other instrument performance options, refer to the Help.

1. On the Navigation bar, under **Tune and Calibrate**, double-click **Manual Tuning**.
2. Run a TOF MS or Product ion scan type and confirm that there is a stable TIC and that the peaks of interest are present in the spectrum..
3. On the navigation bar, under **Tune and Calibrate**, double-click **Instrument Optimization**. The Instrument Optimization dialog opens.
4. Select a tuning solution. Make sure that the tuning solution matches the reference table.
5. The **Verify Performance Only** check box is preselected. Click **Next**.  
For this example, leave this option selected. If the report indicates that the instrument needs tuning, then run Instrument Optimization again and select one or more scan modes to optimize.
6. Make sure that the ion source and syringe parameters are suitable.

---

**Note:** Users can also use the CDS to inject the solution. Make sure the tuning solution matches the configuration in the reference table. Set the appropriate flow rate and then click CDS Inject.

---

**Note:** Make sure that the correct Calibrant Valve Position is selected in the Reference Table Editor for the chosen reference table. CDS can select from up to four different positions, A to D.

---

7. Click **GO**.  
The **Verifying or Adjusting Performance** screen opens. After the process has completed, the **Results Summary** opens. For more information, refer to the Help.

## Verifying or Adjusting Performance Dialog

The top left corner shows the part of the instrument that is being tuned.

The Current Spectrum graph shows the spectrum of the current scan, the optimal scan selected by the software, or the scan at the current parameter value when the software results are viewed in interactive mode.

The Instrument Optimization Decision Plots, in the top right graph, dynamically show the intensity-to-voltage curves of the parameters that are currently being optimized.

## Results Summary

The Results Summary is a record of any instrument settings changes that were made by the Instrument Optimization wizard.

Figure 6-1 Results Summary: TripleTOF 6600 System

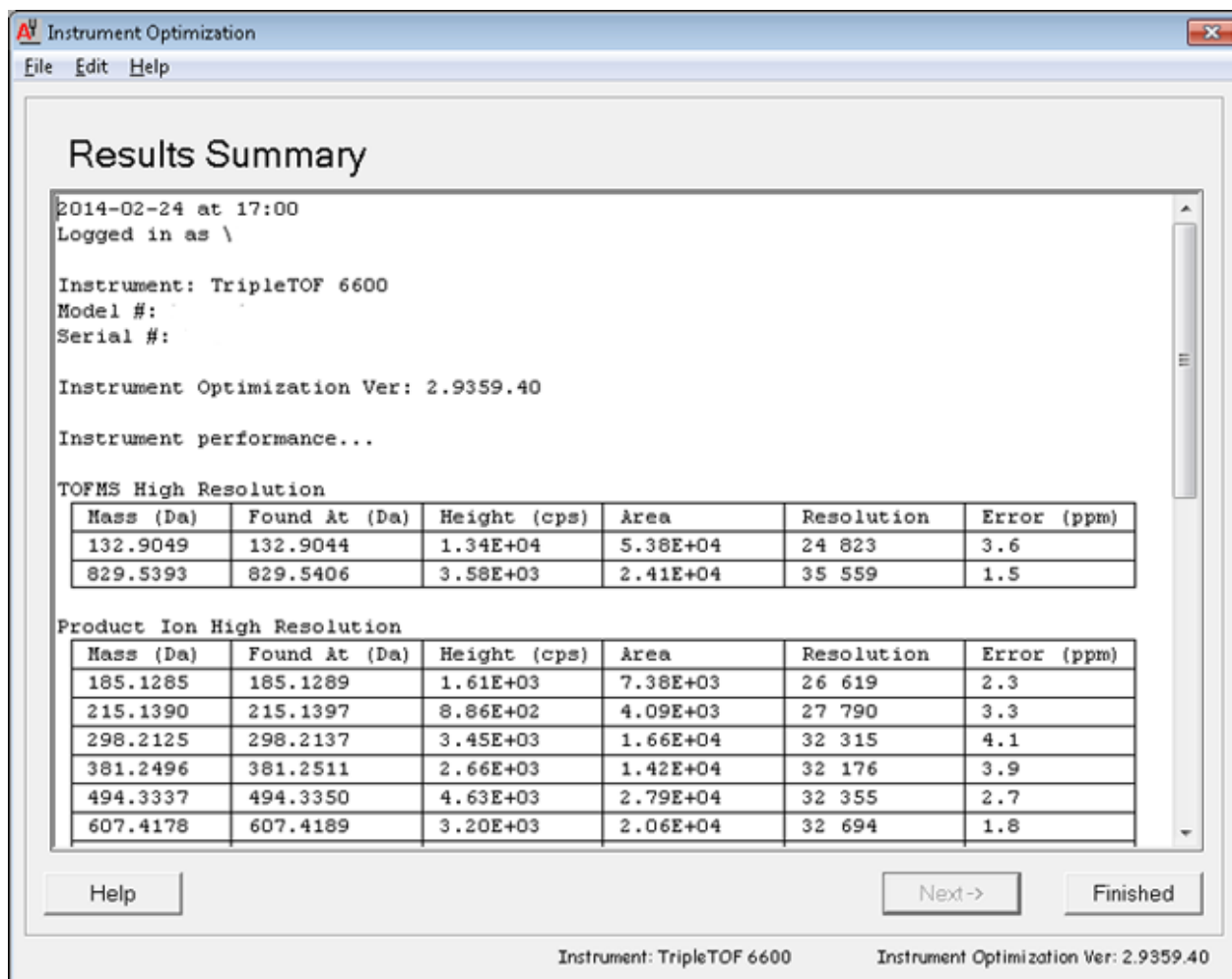

The Results Summary is automatically saved in the following path: <drive>:\Analyst Data\Projects\API Instrument\Data\Instrument Optimization\yyyy-mm-dd\results.pdf, where yyyy-mm-dd is the date on which the report was created. Users can print the Results Summary or open a previously saved Results Summary.

# Operating Instructions — Acquisition Methods

---

# 7

An acquisition method consists of experiments and periods. Use the Acquisition Method Editor to create a sequence of periods and experiments for the mass spectrometer and any devices in the active hardware profile.

An acquisition method consists of the method for the mass spectrometer and for liquid chromatography (LC) devices. Users can easily create an acquisition method using the Method Wizard.

The Acquisition Method Editor can also be used to create acquisition methods and to add a sequence of periods and experiments for the instrument and devices.

Use the SWATH acquisition feature, available in both the Method Wizard and the Acquisition Method Editor, to create SWATH acquisition methods. Also, SWATH Variable width window methods can be created using the Method Wizard or Acquisition Method Editor. For more information, refer to the *Advanced User Guide*, Analyst TF Help, and Method Wizard Help.

We recommend that only users who are proficient in method development create or modify acquisition and quantitation methods. For more information about roles and security, refer to the document: *Laboratory Director Guide*.

## Create an Acquisition Method Using the Acquisition Method Editor

---

**Tip!** If users are creating a new acquisition method file from an existing file, then some or all of the peripheral device methods in the acquisition method might be used.

---

Only devices configured in the active hardware profile are shown in the Acquisition method pane. Any devices added to the hardware profile must also be added to existing acquisition methods. For more information about devices, refer to the document: *Peripheral Devices Setup Guide*.

1. Make sure that a hardware profile containing the mass spectrometer and peripheral devices is active.
2. On the Navigation bar, under **Acquire**, double-click **Build Acquisition Method**.
3. Select a **Synchronization Mode** on the Acquisition Method Properties tab.

4. (Optional) Select the **Auto-Equilibration** check box and then type the required equilibration time, in minutes.
5. In the Acquisition Method pane, click the **Mass Spec** icon.
6. On the MS tab, select a **Scan type**.
7. Type values in the other fields as required.
8. On the Advanced MS tab, type values in the fields as required.
9. On the MS tab, click **Edit Parameters**.
10. On the Source/Gas tab, specify values in the fields as required.
11. On the Compound tab, specify values in the fields as required.
12. Click **OK**.
13. Click a device icon and then set the parameters for the device.
14. Add any additional periods and experiments. Refer to the sections: [Add an Experiment](#) and [Add a Period](#).
15. Click **File > Save**.

## Add an Experiment

1. In the Acquisition method pane, on the period where the experiment is to be added, right-click and then click **Add experiment**.

**Figure 7-1 Add Experiment**

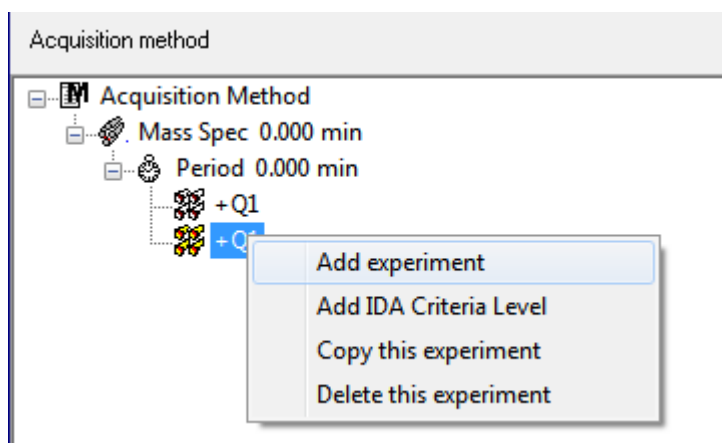

An experiment is added below the last experiment in the period.

**Note:** An experiment cannot be inserted between experiments, IDA criteria, or periods. Users can only add an experiment at the end of the period.

2. On the MS tab, select the appropriate parameters.

### Add a Period

In the Acquisition method pane, right-click the **Mass Spec** icon, and then click **Add period**. A period is added below the last period created.

---

**Note:** Users cannot use multiple periods in an IDA experiment.

---

### Copy an Experiment into a Period

1. Open a multi-period method.
2. In the Acquisition method pane, press **Ctrl**, and then drag the experiment to the period. The experiment is copied below the last experiment in the period.

### Copy an Experiment within a Period

Use this procedure to add the same or similar experiments to a period if most or all of the parameters are the same.

Right-click the experiment and then click **Copy this experiment**.

A copy of the experiment is added below the last experiment created.

## Create an Acquisition Method using the Method Wizard

The acquisition method can be saved in an existing project.

---

**Tip!** To copy the **Method Wizard** template methods into the **Acquisition Methods** folder in the project folder, select the **Copy method templates** check box in the **Create New Project or Subproject** dialog. To open this dialog, click **Tools > Project > Create Project or Create Subproject**.

---

1. Make sure that a hardware profile containing the mass spectrometer and peripheral devices is active.
2. On the software toolbar, make sure that the appropriate project is selected.
3. On the Navigation bar, in **Acquire** mode, double-click **Method Wizard**. The **Method Wizard** opens.

---

**Tip!** Move the cursor over the interface to view tool tips and procedures.

---

4. Select **TOF MS (+)** from the **Choose MS Method** list.



5. Select the LC method that was created for the hardware profile from the **Choose LC Method** list.
6. Type a name for the method and then press **Enter**.
7. Click **Next**.
8. On the **Ion Source Parameters** tab, verify the values, editing them if necessary, and then click **Next**.
9. On the **TOF MS** tab, verify the values, editing them if necessary, and then click **Finish**.

---

**Tip!** If required, users can further edit the acquisition method using the **Acquisition Method Editor**. In **Acquire** mode, click **File > Open** and then open the method that was created using the **Method Wizard**.

---

Next steps: The newly created acquisition method can now be used to acquire data for preliminary analysis.

## Scan Techniques

The system is a versatile and reliable system for performing liquid chromatography mass spectrometry analysis on liquid sample streams to identify, quantify, and examine compounds.

The system uses the following mass spectrometry techniques to analyze samples:

- Two modes of single mass spectrometry (MS):
  - Quadrupole-based single mass spectrometry (for Q1 calibration only)
  - Time-of-flight-based single mass spectrometry
- Two modes of tandem mass spectrometry (MS/MS):
  - Product ion mass spectrometry
  - Precursor ion mass spectrometry

## Single Mass Spectrometry

Single mass spectrometry (MS) is used to analyze charged molecules to find the molecular weight and amount of detected ions. Individual ions detected by MS can indicate the presence of a target analyte.

## Quadrupole-Based Single Mass Spectrometry

In a quadrupole-based single mass spectrometry (Q1 MS) scan, the system functions as a traditional quadrupole mass spectrometer. In this mode, the system generates single mass spectrometric information using the first quadrupole (Q1) section of the instrument.

## Time-of-Flight Single Mass Spectrometry

In a time-of-flight single mass spectrometry (TOF MS) scan, the system generates mass spectrometric information by pulsing ions into a flight tube and recording their precise arrival time at the detector. Ions with a greater mass-to-charge ratio take longer to travel the flight tube.

## Tandem Mass Spectrometry

The technique of MS/MS is well-suited to mixture analysis because the characteristic product ion spectra can be obtained for each component in a mixture without interference from the other components, assuming that the product ions have a unique  $m/z$  ratio.

Use MS/MS for targeted analysis by monitoring specific precursor/product ions while the sample is eluting. This type of analysis is more specific than single MS, which only discriminates on the basis of the mass-to-charge ratio.

## Product Ion Mass Spectrometry

In a product ion scan (**Product Ion**), the system generates mass spectrometric information by selecting a particular precursor ion window in Q1, fragmenting in Q2 (a collision cell) and pulsing the ions (fragment ions) into a flight tube and recording their precise arrival time at the detector. Product ions can provide information on the molecular structure of the original (precursor) ions.

## Precursor Ion Mass Spectrometry

In a precursor ion scan, the system detects precursor ions that generate a specific product ion. The instrument uses Q1 in mass resolving mode to scan over the mass range of interest, while the TOF section records product ion spectra for each precursor ion. The Q1 mass spectrum shows all precursor ions that produce the product ion of interest.

## About Spectral Data Acquisition

For a description of the modes in which spectral data can be acquired, refer to the table: [Table 7-1](#).

Spectral Data can only be acquired from Q1 and Precursor Ion scan types.

**Table 7-1 Spectral Data**

Mode	Description
Profile	The preset value is 0.1 Da. Profile data is the data generated by the mass spectrometer and corresponds to the intensity recorded at a series of evenly spaced discrete mass values. For example, for the mass range 100 Da to 200 Da and step size 0.1, the instrument scans from 100 Da to 200 Da in 0.1 Da increments (for example, 100.0, 100.1, 100.2, 100.3... up to 200.0).

Table 7-1 Spectral Data (continued)

Mode	Description
Peak Hopping	The preset value is 1.0 Da. Peak hopping is a mode of operating a mass spectrometer in which large steps (approximately 1 Da) are made. It has the advantage of speed (fewer data steps are made) but with the loss of peak shape information.

## MS Parameters

The working parameters are the set of mass spectrometer (MS) parameters currently being used.

The compound parameters and source and gas parameters are stored with the method. The resolution and detector parameters are mass spectrometer-dependent and are stored as instrument data. If the Tune and Calibrate mode is used to create a method, then the working parameters can be optimized for best instrument performance. Alternatively, ramp each parameter, one at a time, while cycling the experiment.

- Source and gas parameters: These parameters can change depending on the ion source used.
- Compound parameters: These parameters consist mostly of voltages in the ion path. Optimal values for compound-dependent parameters vary depending on the compound being analyzed.
- Resolution parameters: These parameters affect the resolution and calibration.
- Detector parameters: These parameters affect the detector. The Multi-Channel Plate is the detector in a TOF instrument and consists of four channels for ion detection. The total of the channels equals the ion intensity. This parameter can be optimized using Instrument Optimization.

The parameters in the table apply to the ion source that comes with the system. For information regarding other ion sources, refer to the *Operator Guide* that comes with the ion source. The following figure shows the location of the parameters on the ion optics path.

Figure 7-2 Ion Optics Path and Parameters

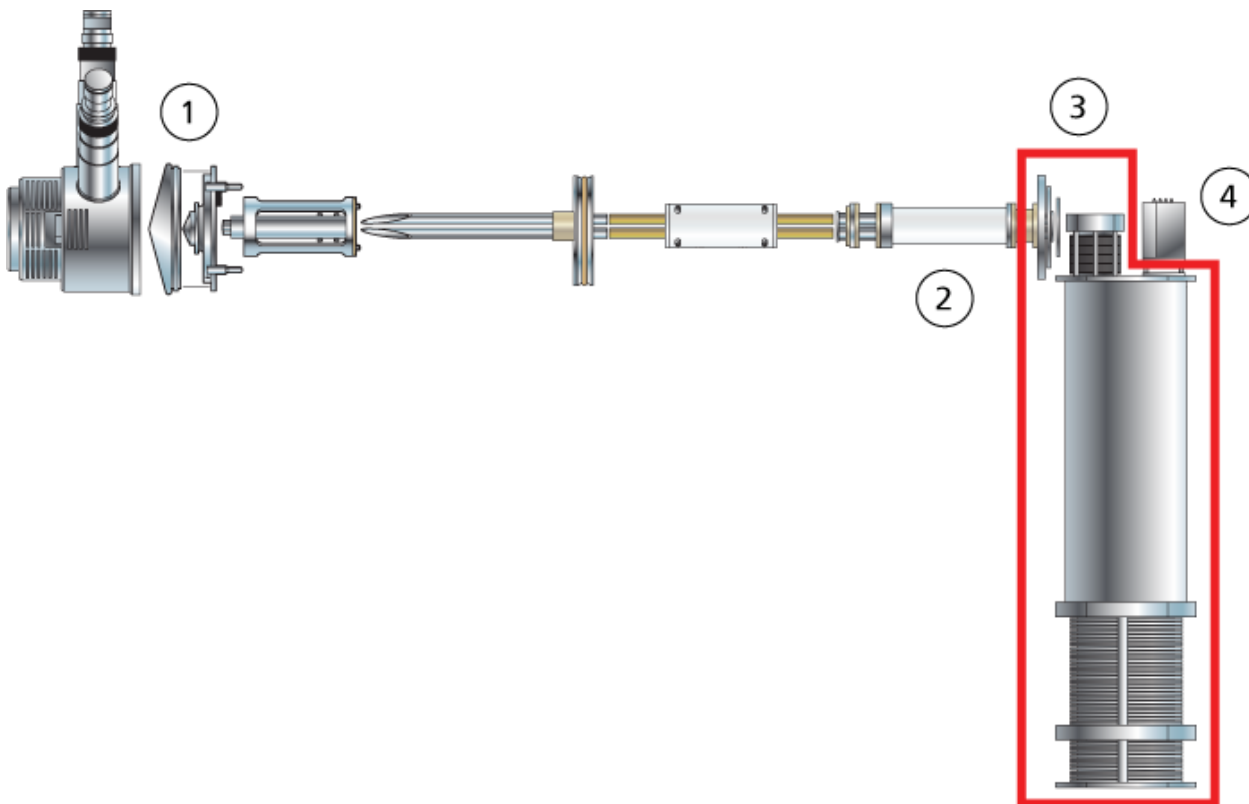

Location	Parameter	Parameter Type	Use	Scan Type
1	IonSpray Voltage Floating (ISVF)	Source and gas	The ISVF parameter affects the stability of the spray and hence the signal sensitivity. This is the voltage applied to the needle that sprays the sample.	All
1	Ion Source Gas 1 (GS1)	Source and gas	The GS1 parameter controls the nebulizer gas for the ESI probe.	All
1	Ion Source Gas 2 (GS2)	Source and gas	The GS2 parameter controls the heater gas for the ESI probe and the nebulizer gas for the APCI probe.	All
1	Temperature (TEM)	Source and gas	The TEM parameter controls the temperature of the heater gas for the TurbolonSpray probe or the temperature of the APCI probe.	All

Location	Parameter	Parameter Type	Use	Scan Type
1	Curtain Gas (CUR)	Source and gas	The CUR parameter controls the flow of the gas for the Curtain Gas interface. The Curtain Gas interface is located between the curtain plate and the orifice. It prevents the contamination of the ion optics.	All
1	Declustering Potential (DP)	Compound	The DP parameter controls the voltage on the orifice, which controls the ability to decluster ions between the orifice and the QJet ion guide. It is used to minimize the solvent clusters that might remain on the sample ions after they enter the vacuum chamber, and, if required, to fragment ions. The higher the voltage, the higher the energy imparted to the ions. If the DP parameter is too high, then unwanted fragmentation might occur.  Use the preset value and optimize for the compound.	All
2	CAD Gas	Source and gas	The CAD parameter controls the pressure of CAD gas in the collision cell. The collision gas helps to focus the ions as they pass through the collision cell; the preset for the CAD parameter is in Fixed mode. For MS/MS scan types, the CAD gas helps to fragment the precursor ions. When the precursor ions collide with the collision gas, they dissociate to form product ions.  Use the preset value and optimize for the compound.	All

## Operating Instructions — Acquisition Methods

Location	Parameter	Parameter Type	Use	Scan Type
2	Collision Energy (CE)	Compound	<p>The CE parameter controls the potential difference between the Q0 region and the Q2 collision cell. It is used only in MS/MS scan types. This parameter is the amount of energy that the precursor ions receive as they are accelerated in the Q2 collision cell, where they collide with gas molecules and fragment.</p> <p>Use the preset value and optimize for the compound.</p>	TOF MS, TOF MS/MS
2	Collision Energy Spread (CES)	Compound	<p>The CES parameter, in conjunction with the CE parameter, determines which three discrete collision energies are applied to the precursor mass in an Product Ion scan when CES is used. The collision energy is ramped from low to high. For example, in Positive mode, the collision energy will be ramped from CE – CES to CE + CES. By entering a CES value, collision energy spread is automatically turned on.</p> <p>Use the preset value and optimize for the compound.</p>	TOF MS/MS
3	Ion Release Delay (IRD)	Compound	<p>The amount of time in milliseconds before the ion pulse. The default (11 msec) is calculated based on the TOF masses and can be adjusted by the operator. The range is typically 6 msec to 333 msec.</p> <p>This parameter is optimized using <b>Instrument Optimization</b> wizard if the <b>Enhanced Ion</b> option is selected in the <b>Advanced</b> options. In general, the default values do not have to be changed.</p>	MS/MS only, Enhanced

Location	Parameter	Parameter Type	Use	Scan Type
3	Ion Release Width (IRW)	Compound	<p>This is the width, or duration, of the ion pulse in milliseconds and is calculated based on the IRD. The range is typically 5 to 328 msec with a default value of 10 msec.</p> <p>This parameter is optimized using the <b>Instrument Optimization</b> wizard if the <b>Enhanced Ion</b> option is selected in the <b>Advanced</b> options. In general, the default values do not have to be changed.</p>	MS/MS only, Enhanced
4	MCP (CEM)	Detector	The CEM parameter controls the voltage applied to the detector. The voltage affects the detector response.	All

---

**CAUTION: Potential System Damage.** If the LC system connected to the mass spectrometer is not controlled by the software, then do not leave the mass spectrometer unattended while in operation. The liquid stream from the LC system can flood the ion source when the mass spectrometer goes in Standby state.

---

A batch is a collection of information about the samples to be analyzed. Samples are usually grouped into sets to simplify submission. Grouping the samples into a set also reduces the amount of data that must be typed manually. A set can consist of a single sample or multiple samples. All of the sets in a batch use the same hardware profile. However, samples in a set can have different acquisition methods. A batch can be submitted only from an acquisition computer.

Batches include the following information:

- Sample information, such as name, ID, and comment
- Autosampler rack information, vial position, and injection volume
- Acquisition methods
- Processing method or script (optional)
- Quantitation information (optional)
- Custom sample data (optional)
- Set information

## Set Queue Options

The software goes one-by-one through the list of samples in the queue, acquiring each sample with the selected acquisition method. After all of the samples have been acquired, the acquisition stops and the mass spectrometer goes into Standby state after the **Max. Idle Time** set in the Queue Options has elapsed. In the Standby state, the LC pumps stop and some instrument voltages are turned off.

The user can change the amount of time between acquisition of the last sample and the change to Standby state. For information about the other fields in the Queue Options dialog, refer to the document: *Help*.

1. On the Navigation bar, click **Configure**.
2. Click **Tools > Settings > Queue Options**.



Figure 8-1 Queue Options Dialog

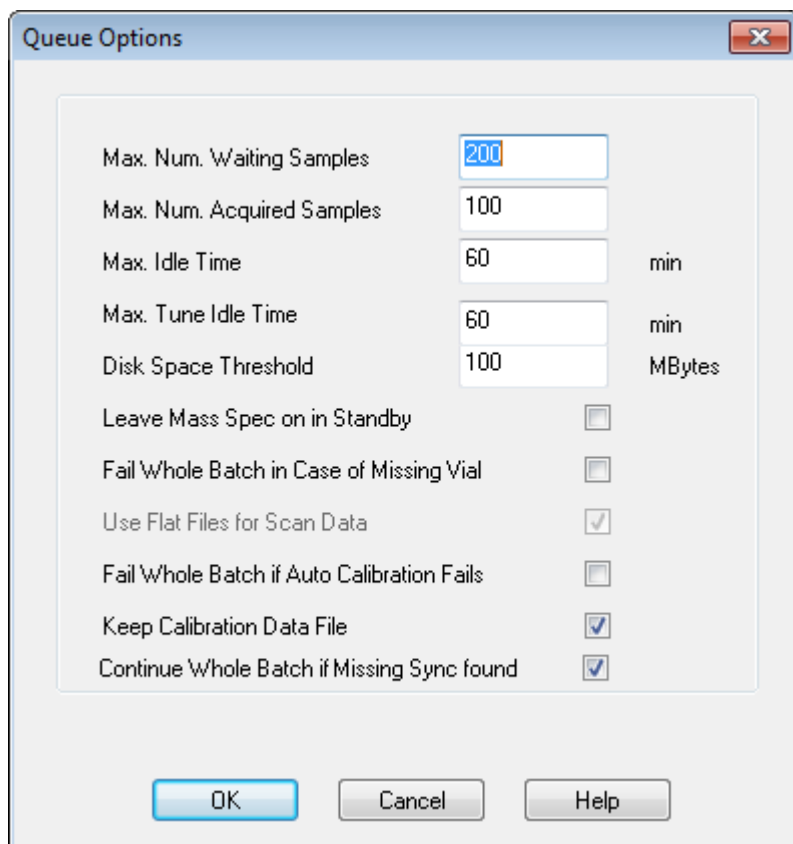

3. In the **Max. Num. Waiting Samples** field, set the maximum number of samples to a value that is greater than the number of samples that will be submitted to the queue.
4. In the **Max. Idle Time** field, type the amount of time the software will wait after acquisition is completed before going to Standby state. The preset value is 60 minutes.

If gas cylinders are used, then adjust this time to make sure that the gas in the cylinders is not depleted.

If an LC method is used, then before the run is started, make sure that there is enough solvent in the reservoirs for all of the sample runs at the primary flow rate and the maximum idle time.

5. Select the **Leave Mass Spec on in Standby** check box to keep the mass spectrometer running after analysis has been completed.

This feature allows the heaters and gases to continue running, even after devices have entered Idle state, so that the ion source and entrance to the mass spectrometer are kept free of contaminants.

## Operating Instructions — Batches

---

6. Select the **Fail Whole Batch in Case of Missing Vial** check box to make the entire batch fail when a missing vial is encountered.  
If this option is not selected, then only the current sample will fail and the software will continue to the next sample.
7. Select the **Fail Whole Batch if Auto Calibration Fails** check box to stop the batch if auto calibration fails.
8. Select the **Keep Calibration Data File** check box to keep the calibration data file in a subfolder in the Data folder of the project from which samples are being submitted.
9. Select the **Continue Whole Batch if Missing Sync found** check box to continue acquiring the whole batch when a missing sync signal is encountered. If this check box is not selected, then the current sample fails and the queue does not proceed to the next sample when this signal is encountered.

## Add Sets and Samples to a Batch

A set can consist of a single sample or multiple samples.

---

**Note:** For more information about adding quantitation information to a batch, refer to the document: *Advanced User Guide*.

---

1. On the Navigation bar, under **Acquire**, double-click **Build Acquisition Batch**.

**Figure 8-2 Batch Editor Dialog**

Sample Name	Rack Code	Rack Position	Plate Code	Plate Position	Vial Position	Data File	Inj. Volume (µl)
-------------	-----------	---------------	------------	----------------	---------------	-----------	------------------

2. On the Sample tab, in the **Set** list, type a name.
3. Click **Add Set**.
4. Click **Add Samples** to add samples to the new set.

Figure 8-3 Add Sample Dialog

The screenshot shows the 'Add Sample' dialog box with the following fields and settings:

- Sample name section:**
  - Prefix: Sample
  - Sample number:
  - Number of digits: 3
- Data file section:**
  - Prefix: Data
  - Set name:
  - Auto Increment:
  - Sub Folder: (empty)
  - Browse button
- New samples section:**
  - Number: 1

Buttons at the bottom: OK, Cancel, Help.

5. In the Sample name section, in the **Prefix** field, type a name for the samples in this set.
6. To add incremental numbering to the end of the sample name, select the **Sample number** check box.
7. If the **Sample number** check box is selected, then in the **Number of digits** field, type the number of digits to include in the sample name.  
For example, if 3 is typed, then the sample names would be samplename001, samplename002, and samplename003.
8. In the Data file section, in the **Prefix** field, type a name for the data file that will store the sample information.
9. Select the **Set name** check box to use the set name as part of the data file name.
10. Select the **Auto Increment** check box to increment the data file names automatically.

---

**Note:** The data for each sample can be stored in the same or a separate data file. The names of the data file will have numerical suffixes starting from 1.

---

11. Type a name in the **Sub Folder** field.  
The folder is stored in the `Data` folder for the current project. If the **Sub Folder** field is left blank, then the data file is stored in the `Data` folder and a subfolder is not created.
12. In the New samples section, in the **Number** field, type the number of new samples to add.

## Operating Instructions — Batches

---

- Click **OK**.  
The sample table fills with the sample names and data file names.

---

**Tip! Fill Down** and **Auto Increment** options are available in the right-click menu after a single column heading or several rows in a column are selected.

---

- On the Sample tab, in the Acquisition section, select a method from the list.  
Depending on how the system is set up, specific information for the autosampler must be entered. Even if the injection volume is set in the method, the user can change the injection volume for one or more samples by changing the value in the injection volume column.

---

**Note:** To use different methods for some of the samples in this set, select the **Use Multiple Methods** check box. The **Acquisition Method** column is shown in the Sample table. Select the acquisition method for each sample in this column.

---

- To change the injection volumes from the volumes listed in the method, in the **Inj. Volume (µL)** column, type the injection volume for each sample.
- To set sample locations, do one of the following:
  - [Set Sample Locations in the Batch Editor](#)
  - [Select Vial Positions Using the Locations Tab \(Optional\)](#)
- Open the Submit tab.

---

**Note:** The order of samples can be edited before the samples are submitted to the queue. To change the order of samples, on the Submit tab, double-click any of the numbers at the far left of the table (a very faint square box is shown), and then drag them to the new location.

---

- If the Submit Status section contains a message about the status of the batch, then do one of the following:
  - If the message indicates that the batch is ready for submission, then go to step [19](#).
  - If the message indicates that the batch is not ready for submission, then make the changes as indicated by the message.
- After confirming that all of the batch information is correct, click **Submit**.  
The batch is submitted to the queue and can be viewed in the Queue Manager.
- Save the file.

---

## Submit a Sample or Set of Samples

---

**Note:** Run the sample again if an abnormal termination occurs during sample acquisition. If the abnormal termination is caused by a power failure, then the temperature of the autosampler tray is not maintained and sample integrity might be compromised.

---

1. Select one sample or a set of samples.
2. Open the Submit tab in the Batch Editor.
3. If the Submit Status group contains a message about the status of the batch, then do one of the following:
  - If the message indicates that the batch is ready for submission, then go to the next step.
  - If the message indicates that the batch is not ready for submission, then make the changes as indicated by the message.
4. Click **Submit**.

## Set Up Sample Calibration

The software can automatically schedule and execute the external auto calibration while samples are being acquired in batch mode. This ensures good mass accuracy is maintained throughout the acquisition.

If the CDS is not configured, calibration is done using an autosampler and users must supply the calibration method (\*.dam) and the vial position of the calibrant sample.

1. In the **Batch Editor**, click the **Calibrate** tab.
2. In the **Calibrate Every \_ Samples** field, type the number of samples to be acquired between calibration samples.
3. From the **Calibrant Reference Table**, select a table from the list of all calibrant reference tables available for the current polarity. Make sure that the selected reference table has the correct **Calibrant Valve Position**.
4. Set the **CDS Inject Flow Rate**.

When the batch is submitted, the calibration samples are inserted into the queue. Each set starts with a calibration sample. The calibration method is named AnalystCal\_ plus the acquisition method name (for example, AnalystCal\_TOF.dam). If the CDS is configured, the software automatically creates a calibration method that matches the acquisition method that is used for the next sample in the queue. Calibration data is saved to a separate data file for each calibration sample. The calibration data file along with the calibration report is saved in the subfolder Cal Data and named with Cal plus the time stamp and calibration sample index (for example, Cal200906261038341.wiff) if the Keep Calibration Data File was selected in the Queue Options dialog. The calibration report is

named with Cal plus the time stamp, calibration sample index, and the word report (for example, Cal20130822154447030\_report.txt). The report displays the peak finding criteria, the parameters, and the masses used for calibration. It informs the users whether the calibration succeeded. The report also summarizes the parameters used for calibration.

## Change Sample Order

The order of the samples can be changed before the samples are submitted to the **Queue**.

On the Submit tab, double-click any of the numbers at the far left of the table (a very faint square box is visible), and then drag them to the new location.

## Acquire Data

The software must not be in Tune and Calibrate mode when sample acquisition is started. Also, if the system has been previously run that day and has not yet been set to Standby state, then sample acquisition will start automatically.

1. Make sure that the column oven temperature is reached.
2. Make sure that the **Reserve Instrument for Tuning** (  ) icon is not pressed in.
3. On the Navigation bar, click **Acquire**.
4. Click **View > Sample Queue**.  
The Queue Manager opens with all of the submitted samples.

**Figure 8-4 Queue Manager**

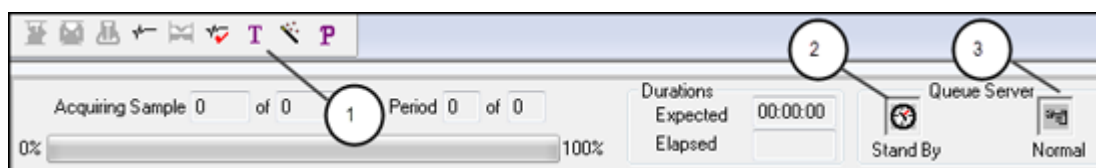

Item	Description
1	The <b>Reserve Instrument for Tuning</b> icon should not be pressed in.
2	Queue state must be Ready.
3	<b>Queue Server</b> state must be Normal. Refer to the section: <a href="#">Queue States</a> .

5. Click **Acquire > Start Sample**.

## Set Sample Locations in the Batch Editor

If an autosampler is used in the acquisition method, then the vial positions of the samples must be defined in the acquisition batch. Define the location on the Sample tab or on the Locations tab. For more information about creating batches, refer to the section: [Add Sets and Samples to a Batch](#).

1. On the Sample tab, in the **Set** list, select the set.
2. For each sample in the set, do the following if applicable:
  - In the **Rack Code** column, select the rack type.
  - In the **Rack Position** column, select the position of the rack in the autosampler.
  - In the **Plate Code** column, select the plate type.
  - In the **Plate Position** column, select the position of the plate on the rack.
  - In the **Vial Position** column, type the position of the vial in the plate or tray.
3. Save the file.

## Select Vial Positions Using the Locations Tab (Optional)

1. In the Batch Editor, open the Locations tab.
2. In the **Set** list, select the set.
3. From the **Autosampler** list, select the autosampler.
4. In the space associated with the rack, right-click and then select the rack type. The plates or trays are shown in the rack.
5. Double-click in the white space labeled rack type. A visual sample rack layout is shown. The appropriate number of rack spaces for the autosampler is shown in the graphic rack view.
6. Double-click one of the rectangles. The circles depicting the wells or vials for the plate or tray are shown.

---

**Tip!** To see the corresponding vial number in the graphical representation, move the cursor over the sample position. Use this information to confirm that the vial positions in the software match the vial positions in the autosampler.

---

**Figure 8-5 Locations Tab**

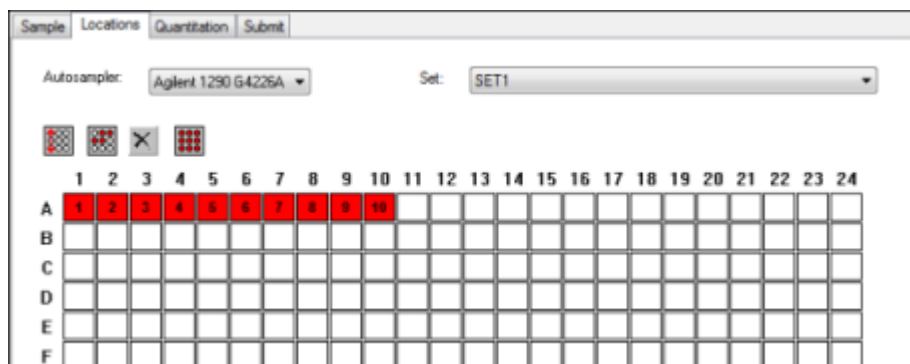

---

**Note:** Depending on the autosampler being used, it might not be necessary to type details in additional columns.

---

7. To select whether samples are marked by row or column, click the **Row/Column selection** selector button.  
If the button shows a red horizontal line, then the Batch Editor marks the samples by row. If the button shows a red vertical line, then the Batch Editor marks the samples by column.
8. Click the sample wells or vials in the order in which they should be analyzed.

---

**Tip!** Click a selected well or vial again to clear it.

---

---

**Tip!** To fill in the samples automatically, press **Shift** while clicking the first and last vial within a set. To perform multiple injections from the same vial, press **Ctrl** while clicking the vial location. The red circle changes to a green circle.

---

## Stop Sample Acquisition

When a sample acquisition is stopped, the software completes the current scan before stopping acquisition.

1. In the Queue Manager, click the sample in the queue after the point where acquisition should stop.
2. On the Navigation bar, click **Acquire**.
3. Click **Acquire > Stop Sample**.  
The acquisition stops after the current scan in the selected sample is acquired. The sample status in the **Queue Manager (Local)** window changes to **Terminated**, and all other samples following in the queue are **Waiting**.
4. To continue processing the batch, click **Acquire > Start Sample**.



## Queue States and Device Status

The Queue Manager shows queue, batch, and sample status. Detailed information about a particular sample in the queue can also be viewed.

**Tip!** Click **View Queue** () to view the queue.

For information on using the Queue right-click menu, refer to the section: [Queue](#).

### Queue States

The current state of the queue is indicated in the Queue Server group.

**Figure 8-6 Queue Server Indicator Showing Normal Mode**

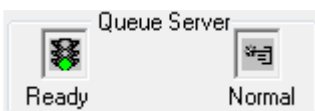

**Figure 8-7 Queue Server Indicator Showing Tune Mode**

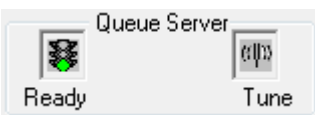

The first icon indicates the queue state. The second icon indicates whether the queue is in Tune mode (for tuning) or Normal mode (for running samples). For descriptions of the icons and queue states, refer to the table: [Table 8-1](#).

**Table 8-1 Queue States**

Icons	State	Definition
	<b>Not Ready</b>	The hardware profile is deactivated and the queue is not accepting any sample submissions.
	<b>Stand By</b>	The hardware profile has been activated, but all devices are idle. Pumps are not running and gases are turned off.

Table 8-1 Queue States (continued)

Icons	State	Definition
	<b>Warming Up</b>	The mass spectrometer and devices are equilibrating, columns are being conditioned, the autosampler needle is being washed, and column ovens are reaching temperature. The duration of equilibration is selected by the operator. From this state, the system can go to the <b>Ready</b> state.
	<b>Ready</b>	The system is ready to start running samples and the devices have been equilibrated and are ready to run. In this state, the queue can receive samples and will run after samples are submitted.
	<b>Waiting</b>	The system will automatically begin acquisition when the next sample is submitted.
	<b>PreRun</b>	The method is being downloaded to each device and device equilibration is occurring. This state occurs before the acquisition of each sample in a batch.
	<b>Acquiring</b>	The method is running and data acquisition is occurring.
	<b>Paused</b>	The system has been paused during acquisition.





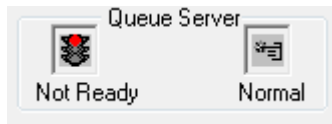
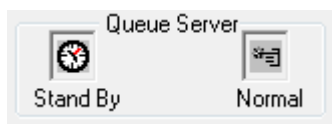
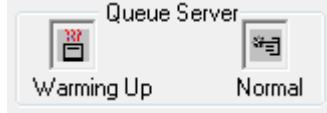
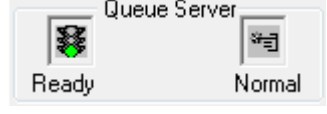
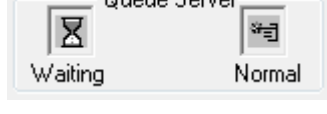
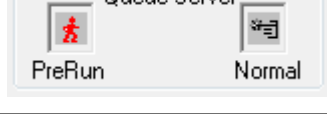
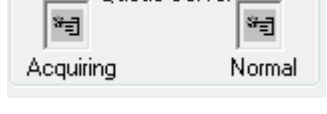
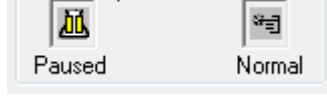



## View Instrument and Device Status Icons

Icons representing the mass spectrometer and each device in the active hardware configuration are shown on the status bar in the bottom right corner of the window. The user can view the detailed status of an LC pump to make sure the LC pump pressure is appropriate or view the detailed status of the mass spectrometer to monitor the temperature of the ion source.

**Note:** For each status, the background color can be red. A red background indicates that the device encountered an error while in that state.

On the status bar, double-click the icon for the device or mass spectrometer. The Instrument Status dialog opens.

**Table 8-2 Instrument and Device Status Icons**

Status	Icon	Background Color	Description
Idle		Green or yellow	The device is not running. If the background color is yellow, then the device should be equilibrated before it is ready to run. If the background color is green, then the device is ready to run.
Equilibrating		Green or yellow	The device is equilibrating.
Waiting		Green	The device is waiting for a command from the software or another device, or for some action by the operator.
Running		Green	The device is running a batch.
Aborting		Green	The device is aborting a run.
Downloading		Green	A method is being transferred to the device.
Ready		Green	The device is not running, but is ready to run.
Error		Red	The device has encountered an error that should be investigated.

# Operating Instructions — Analyze and Explore Data

---

# 9

Use the sample files installed in the Example folder to learn how to view and analyze data using the most common analysis and processing tools. For more information about the following topics, refer to the document: *Advanced User Guide*.

- Labeling graphs
- Overlaying and summing spectra or chromatograms
- Performing background subtractions
- Smoothing algorithms
- Working with smoothed data
- Working with centroid data
- Working with contour plots
- Working with the fragment interpretation tool
- Working with library databases and library records

## Open Data Files

---

**Tip!** To turn off the automatic update on the mass spectrum, right-click the mass spectrum and then click **Show Last Scan**. If there is a check mark beside **Show Last Scan**, then the spectrum will update in real-time.

---

1. On the Navigation bar, under **Explore**, double-click **Open Data File**. The Select Sample dialog is shown.
  2. In the **Data Files** list, navigate to the data file to open, select a sample, and then click **OK**. The data acquired from the sample is shown. If data is still being acquired, then the mass spectrum, DAD/UV trace, and TIC continue to update automatically.
- 

**Tip!** To see an example data file, make sure that the **Example** project is selected. Open the TOF folder, and then open the **TOFMS PPGs3000.wiff** file. In the Sample list, select **TOFMS**.

---

## Navigate Between Samples in a Data File



---

**Note:** If samples were saved in separate data files, then open each file individually.

---

For descriptions of the navigation icons used in this procedure, refer to the table: [Table C-4](#).

Open a data file that contains multiple samples and then do one of the following:

- To skip to the next sample in the data file, click the **Show Next Sample** icon (.
- To skip to a non-sequential sample, click the **Go to Sample** icon (.
- In the Select Sample dialog, from the **Sample** list, select the sample to view.
- To go to the previous sample in the data file, click the **Show Previous Sample** icon (.

## View Experimental Conditions

The experimental conditions used to collect data are stored in the data file with the results. The information contains the details of the acquisition method used: the MS acquisition method, that is, the number of periods, experiments, and cycles, including instrument parameters, and the LC device method, including the LC pump flow rate. In addition, it also contains the MS resolution and mass calibration tables used for the sample acquisition. For the software functionality available when the user views the file information, refer to the section: [Show File Information Pane Right-click Menu](#).

---

**Note:** If data is acquired from more than one sample into the same wiff file, then the file information pane does not refresh automatically when the user scrolls through the samples. Close the file information pane and then open it again to view the details for the next sample in the wiff file.

---

Click **Explore > Show > Show File Information**.

The File Information pane opens below the graph.

---

**Tip!** To create an acquisition method from the File Information pane, right-click the File Information pane and then click **Save Acquisition Method**.

---

## Show Data in Tables

1. Open a data file.
2. Click **Explore > Show > Show List Data**.  
The data is shown in a pane below the graph.

Figure 9-1 Peak List Tab (TripleTOF systems)

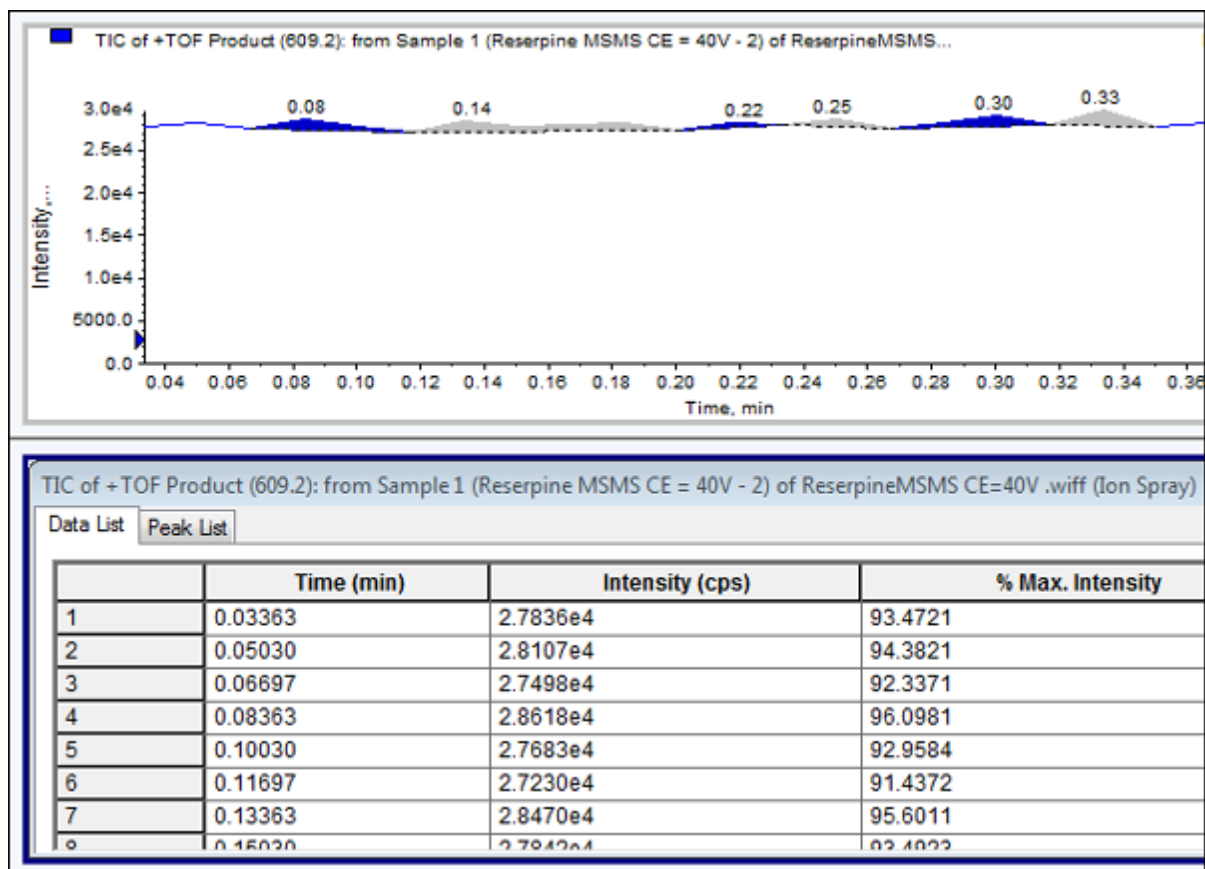

Table 9-1 Right-click Menu for the Spectral Peak List Tab

Menu	Function
Column Options	Opens the <b>Select Columns for Peak List</b> dialog.
Save As Text	Saves the data as a .txt file.
Delete Pane	Deletes the selected pane.

Table 9-2 Right-click Menu for the Chromatographic Peak List Tab

Menu	Function
Show Peaks in Graph	Show the peaks in two colors in the graph.
IntelliQuan Parameters	Opens the <b>IntelliQuan</b> dialog.
Save As Text	Saves the data as a txt file.

Table 9-2 Right-click Menu for the Chromatographic Peak List Tab (continued)

Menu	Function
Delete Pane	Deletes the selected pane.

## Show ADC Data

Analog-to-digital converter (ADC) data is acquired from a secondary detector, for example from a UV detector through an ADC card, and is useful for comparison with mass spectrometer data. To make ADC data available, acquire the ADC data and the mass spectrometer data simultaneously. Both types of data are then saved in the same file.

1. Make sure that the project folder where the ADC data is stored is selected. For example, click the `Example` folder.
2. On the Navigation bar, under **Explore**, double-click **Open Data File**.  
The Select Sample dialog opens.
3. In the **Data Files** field, double-click the sub-data folder (if applicable), and then click the data file to be opened. For example, in the `Example` folder, double-click **Devices** and then click **Adc16chan.wiff**.
4. In the **Samples** list, select a sample, and then click **OK**.
5. Click **Explore > Show > Show ADC Data**.

Figure 9-2 Select ADC Channel Dialog

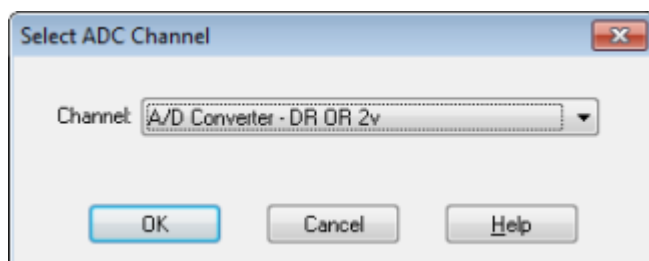

6. In the **Channel** list, select a channel, and then click **OK**.  
The ADC data is shown in a new pane beneath the active pane.

## Show Basic Quantitative Data

1. Open a data file.
2. Click **Explore > Show > Show List Data**.

Figure 9-3 List Data

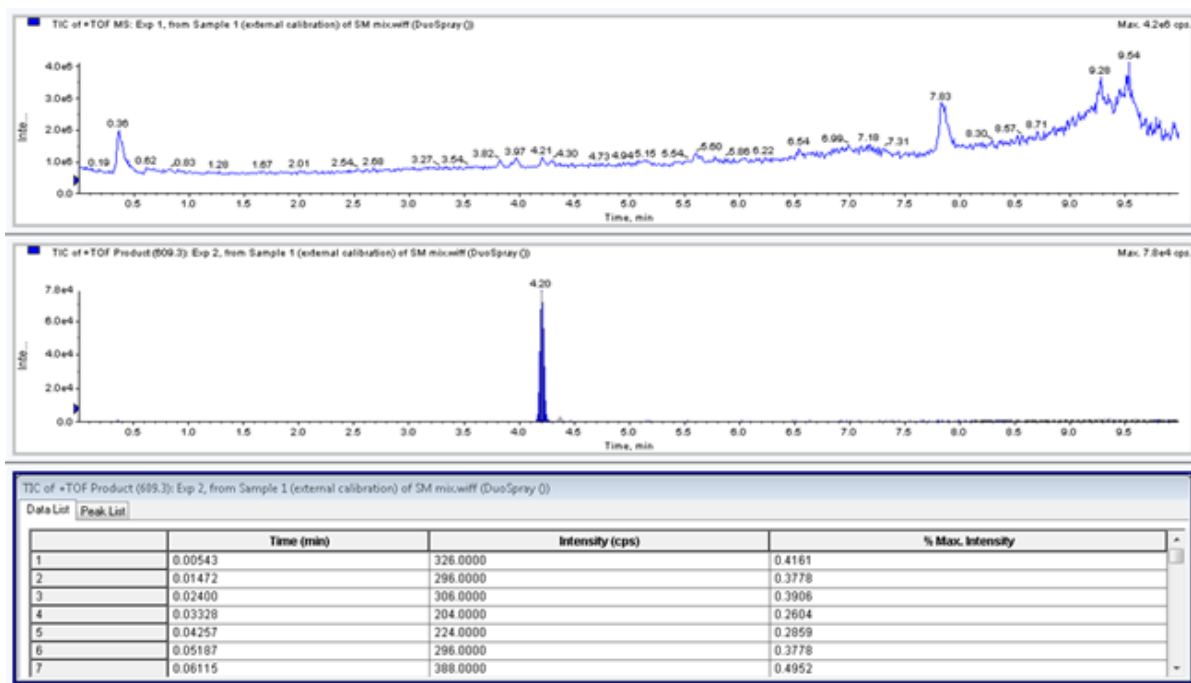

- On the Peak List tab, right-click and then select **Show Peaks in Graph**. Peaks are shown in two colors.
- To change the peak finding algorithm settings, right-click and then select either **Analyst Classic Parameters** or **IntelliQuan Parameters**, whichever is active.
- (Optional) To remove the colored peaks, right-click in the Peak List tab and then clear **Show Peaks in Graph**.

## Chromatograms

A chromatogram is a graphical view of the data obtained from the analysis of a sample. It plots the signal intensity along an axis that shows either time or scan number. For more information about software functionality available for chromatograms, and on using the Chromatogram Panes right-click menu, refer to the section: [Chromatogram Panes](#).

The software plots intensity, in counts per second (cps), on the Y-axis against time on the X-axis. Peaks above a set threshold are labeled automatically. In the case of LC-MS, the chromatogram is often shown as a function of time. For a description of the types of chromatograms, refer to the table: [Table 9-3](#).

For more information about using the available icons, refer to the table: [Table 9-5](#).



**Table 9-3 Types of Chromatograms**

Types of Chromatograms	Purpose
Total Ion Chromatogram (TIC)	<p>A chromatogram generated by plotting the intensity of all ions in a scan against time or scan number.</p> <p>When a data file is opened, it is preset to open as a TIC. If the experiment contains only one scan, then it is shown as a spectrum.</p> <p>If the <b>MCA</b> check box is selected during acquisition of the data file, then the data file opens to the mass spectrum. If the <b>MCA</b> check box is not selected, then the data file opens as the TIC.</p>
Extracted Ion Chromatogram (XIC)	<p>An chromatogram created by taking intensity values at a single, discrete mass value, or a mass range, from a series of mass spectral scans. It indicates the behavior of a given mass, or mass range, as a function of time.</p>
Base Peak Chromatogram (BPC)	<p>A chromatogram that shows the intensity of the most intense ion within a scan versus time or scan number.</p>
Total Wavelength Chromatogram (TWC)	<p>A chromatogram created by summing all of the absorbance values in the acquired wavelength range and then plotting the values against time. It consists of the summed absorbances of all ions in a scan plotted against time in a chromatographic pane.</p>
Extracted Wavelength Chromatogram (XWC)	<p>A subset of TWC. An XWC shows the absorbance for a single wavelength or the sum of the absorbance for a range of wavelengths.</p>
Diode Array Detector (DAD)	<p>A chromatogram that shows the absorption spectrum of eluting compounds at one or more wavelengths.</p>

## Show TICs from a Spectrum

Click **Explore > Show > Show TIC**.

The TIC opens in a new pane.

---

**Tip!** Right-click inside a pane containing a spectrum and then click **Show TIC**.

---

For information on using the **Spectra Panes** right-click menu, refer to the section: [Spectra Panes](#)

## Show a Spectrum from a TIC

A TIC is created by summing the intensity contributions of all ions from a series of mass scans. Use the TIC to view an entire data set in a single pane. It consists of the summed intensities of all of the ions in a scan plotted against time in a chromatographic pane. If the data contains results from multiple experiments, then a TIC for each experiment can be created below the TIC that represents the sum of all of the experiments.

When a data file is opened, it is preset to be shown as a TIC. However, if the experiment contains only one scan, it is shown as a spectrum. If the user selects the **MCA** check box before acquiring the data file, then the data file opens to the mass spectrum. If the **MCA** check box is not selected, then the data file opens with the TIC.

For information on using the Spectra Panes right-click menu, refer to the section: [Spectra Panes](#).

1. In a pane containing a TIC, select a range.
2. Click **Explore > Show > Show Spectrum**.  
The spectrum opens in a new pane.

---

**Tip!** Double-click in the TIC pane at a particular time to show the spectrum.

---

**Figure 9-4 Example of a TIC**

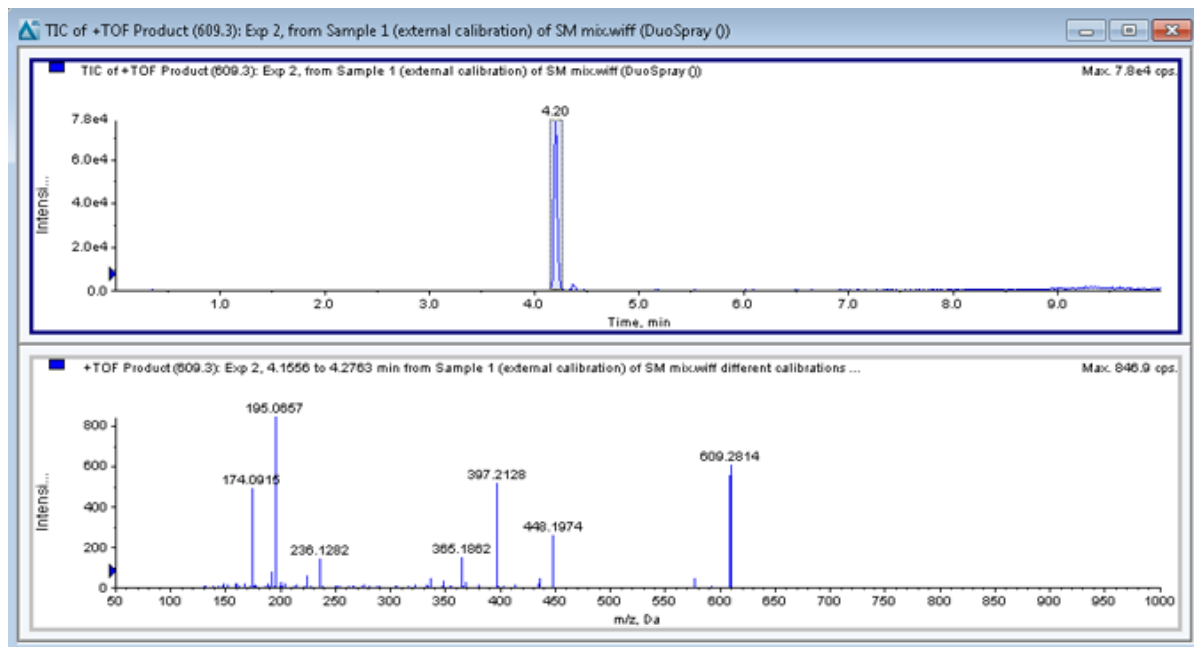

## Generate XICs

XICs can be generated only from single-period, single-experiment chromatograms or spectra. To obtain an XIC from multi-period or multi-experiment data, split the data into separate panes by clicking the triangle under the X-axis. For more information about using the available icons, refer to the table: [Table 9-5](#).

Several methods are available for extracting ions to generate an XIC, depending on whether chromatographic or spectral data is used. For a summary of methods that can be used with chromatograms and spectra, refer to the following table.

**Table 9-4 Summary of XIC Generation Methods**

Method	Use with Chromatogram	Use with Spectrum	Extraction
Selected range	No	Yes	Extracts ions from a selected area in a spectrum.
Maximum	No	Yes	Extracts ions from a selected area in a spectrum using the most intense peak in the selected area. This option creates an XIC using the maximum mass from the selected spectral range.
Base peak masses	Yes	Yes	Can be used only with Base Peak Chromatograms (BPCs). Use the <b>Use Base Peak Masses</b> command to extract ion results in an XIC with a different colored trace for each mass. If the selection includes multiple peaks, then the resulting XIC will have an equal number of colored traces, one for each mass.
Specified masses	Yes	Yes	Extracts ions from any type of spectrum or chromatogram. Select up to ten start and stop masses for which to generate XICs.

### Generate an XIC Using a Selected Range

1. Open a data file containing spectra.
2. Select a range by pressing the left mouse button at the start of the range, dragging the cursor to the end of the range, and then releasing the left mouse button.

The selection is shown in blue.

3. Click **Explore > Extract Ions > Use Range**.  
An XIC of the selection opens in a pane below the spectrum pane. The experiment information at the top of the pane contains the mass range and the maximum intensity in counts per second.

### Generate an XIC Using the Maximum Peak

1. Open a data file containing spectra.
2. Select a range in a spectrum.  
The selection is shown in blue.
3. Click **Explore > Extract Ions > Use Maximum**.  
An XIC of the maximum peak specified selection opens below the spectrum pane. The experiment information at the top of the pane contains the mass range and the maximum intensity in counts per second.

### Generate an XIC Using Base Peak Masses

1. Open a data file containing spectra.
2. In a BPC, select the peak from which to extract ions.  
The selection is shown in blue.
3. Click **Explore > Extract Ions > Use Base Peak Masses**.  
An XIC of the specified selection opens below the spectrum pane. The experiment information at the top of the pane shows the mass range and the maximum intensity in counts per second.

### Extract Ion by Selecting Masses

1. Open a spectrum or chromatogram.
2. Click **Explore > Extract Ions > Use Dialog**.

**Figure 9-5 Extract Ions Dialog**

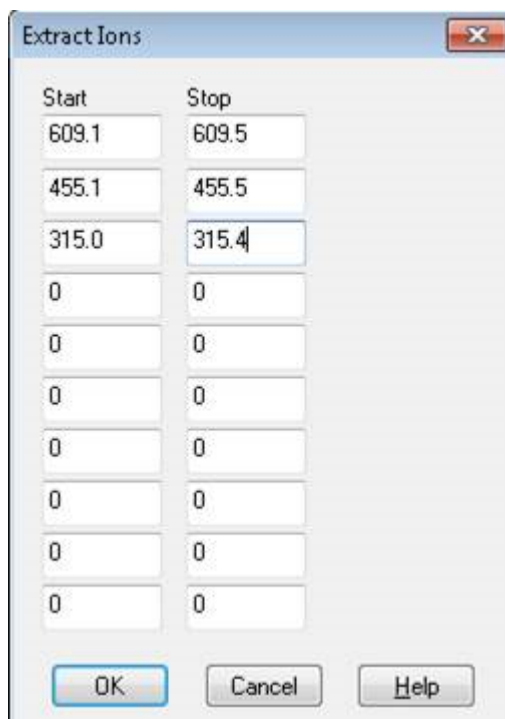

3. Type the values for each XIC to be created.
  - In the **Start** field, type the start value (lower value) for the mass range.
  - In the **Stop** field, type the stop value (higher value) for the mass range.

---

**Note:** If a stop value is not typed, then the range is defined by the start value.

---

4. Click **OK**.  
An XIC of the selection opens below the chromatogram pane. The experiment information at the top of the pane includes the masses and the maximum intensity in counts per second.

## Generate BPCs

BPCs can be generated only from single-period, single-experiment data.

1. Open a data file.
2. Select an area within a TIC.  
The selection is shown in blue.
3. Click **Explore > Show > Show Base Peak Chromatogram**.  
The selections are shown in the **Start Time** and **End Time** fields.

**Figure 9-6 Base Peak Chromatogram Options**

Base Peak Chromatogram Options

Mass Tolerance: 1 ppm

Minimum Intensity: 0 cps

Minimum Mass: 300 Da

Maximum Mass: 2400 Da

Use Limited Range

Start Time: 31.8812956 min

End Time: 33.603232 min

OK Cancel Help

4. In the **Mass Tolerance** field, type the value to indicate the mass range used to find a peak. The software finds the peak using a value twice the typed range ( $\pm$  the mass value).
5. In the **Minimum Intensity** field, type the intensity below which peaks are ignored by the algorithm.
6. In the **Minimum Mass** field, type the mass at the beginning of the scan range.
7. In the **Maximum Mass** field, type the mass at the end of the scan range.
8. To set the start and end times, select the **Use Limited Range** check box and do the following:
  - In the **Start Time** field, type the time when the targeted range of the experiment starts.
  - In the **End Time** field, type the time when the targeted range of the experiment ends.
9. Click **OK**.  
The BPC is generated in a new pane.

## Generate XWCs

An XWC is a wavelength chromatogram created by taking intensity values at a single wavelength, or by taking the sum of the absorbance for a range of several wavelengths. Up to three ranges can be extracted from a DAD spectrum to generate the XWC. For more information about using the available icons, refer to the table: [Table 9-5](#).

1. Open a data file that contains a DAD spectrum.
2. Right-click anywhere in the pane and then click **Extract Wavelengths**.

**Figure 9-7 Extract Wavelengths Dialog**

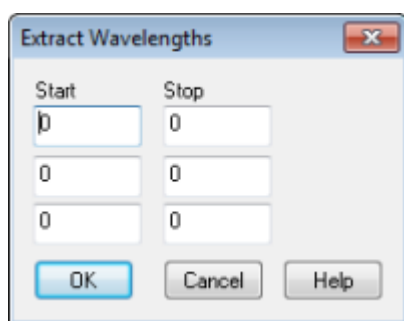

3. Type **Start** and **Stop** values.
4. Click **OK**.  
The XWC is shown in a pane below the DAD spectrum.

## Show DAD Data

Like mass spectrometer data, DAD data can be viewed in chromatogram or spectrum form. Users can view the DAD spectrum for a single point in time, or for a range of time as a Total Wavelength Chromatogram (TWC).

1. Open a data file containing data acquired with a DAD.  
The TWC, which is analogous to a TIC, opens in a pane below the TIC.
2. In the TWC pane, click a point to select a single point in time, or highlight an area of the spectrum to select a range of time.
3. Click **Explore > Show > Show DAD Spectrum**.  
The DAD spectrum opens in a pane below the TWC. The Y-axis shows the absorbance and the X-axis shows the wavelength.

---

**Tip!** If the pane with the TWC is closed, then click a point anywhere in the TWC to open it again. Click **Explore > Show > Show DAD TWC**.

---

## Generate TWCs

A TWC is a less commonly used chromatogram. It shows the total absorbance (mAU) as a function of time. The TWC provides a way of viewing an entire data set in a single pane. It consists of the summed absorbances of all ions in a scan plotted against time in a chromatogram. If the data contains results from multiple experiments, then a TWC for each experiment can be created below the TWC that represents the sum of all of the experiments.

A TWC shows total absorbance (mAU) on the Y-axis plotted against time on the X-axis. For more information about using the available icons, refer to the table: [Table 9-5](#).

1. Open a data file that contains a DAD spectrum.
2. Click **Explore > Show > Show DAD TWC**.  
The TWC is shown in a pane below the DAD spectrum.

---

**Tip!** Right-click inside the pane containing the DAD spectrum and then click **Show DAD TWC**.

---

## Adjust the Threshold

The threshold is an invisible line drawn parallel to the X-axis of a graph that sets a limit below which the software will not include peaks in a spectrum. The line has a handle, represented by a blue triangle to the left of the Y-axis. Click the blue triangle to view a dotted line that represents the threshold. The threshold can be raised or lowered, but changing the threshold value does not change the data. The software does not label any peaks in the region that lies below the threshold.

1. Open a data file.
2. Do one of the following:
  - To raise the threshold, drag the blue triangle up the Y-axis.
  - To lower the threshold, drag the blue triangle down.
  - Click **Explore > Set Threshold**. In the Threshold Options dialog that opens, type the threshold value and then click **OK**.
  - Click **Explore > Threshold**.

The graph updates to show the new threshold. Peak labeling and the peak list are also updated.

---

**Tip!** To view the current threshold value, move the pointer over the threshold handle.

---



## Graphical Data Processing

Graphical data can be processed many ways. This section provides information and procedures for using some of the most commonly used tools.

### Graphs

Graphical data can be examined in different ways. This section provides information and procedures for using some of the most commonly used features.

Data can also be kept for comparison purposes before processing operations such as smoothing or subtraction are performed.

A window contains one or more panes arranged in such a way that all of the panes are fully visible and that they do not overlap.

Panes might be of a variable or fixed size. Panes are automatically tiled within the window and are arranged into column and row format. If the size of a window is changed, then the panes within the window change in size to accommodate the new size. A window cannot be sized to the point where any of the panes become smaller than their minimum size.

Two or more windows or panes containing similar data can be linked, for example, spectra with similar mass ranges. As one pane or window is zoomed in, the other pane zooms in simultaneously. For example, the user can link an XIC to the BPC from which the XIC was extracted. Zooming in the BPC also zooms the XIC, so that both chromatograms show the same magnification.

### Manage Data

Use the following menu options or icons to manage data in graphs.

**Table 9-5 Graph Options**











To do this	Use this menu option	Or click this icon
Copy a graph to a new window	Select the graph to copy. Click <b>Explore &gt; Duplicate Data &gt; In New Window.</b>	
Rescale a graph to its original size	Select the graph. Click <b>Explore &gt; Home Graph.</b>	

Table 9-5 Graph Options (continued)

To do this	Use this menu option	Or click this icon
Move a pane	<ul style="list-style-type: none"> <li>• Select the graph. Click <b>Window &gt; Move Pane.</b></li> <li>• Select the pane or window and then drag it to the new position. This position can be inside the same window or within another window.</li> </ul> <p>A four-headed arrow is shown when the cursor is on the boundary of the active window or pane.</p> <ul style="list-style-type: none"> <li>• If the pane is at the top or bottom of the target pane, then the pane moves above or below that pane, respectively.</li> <li>• If the pane is at the left or right of the target pane, then the pane moves to the left or right of that pane, respectively.</li> <li>• If the pane is at any other position, then the pane moves to the target row. The drop shadow of the pane as the pane is moved indicates its new position.</li> </ul>	
Link panes	<ol style="list-style-type: none"> <li>a. With the two graphs open, click one to make that pane active.</li> <li>b. Click <b>Explore &gt; Link</b> and then click the other pane.</li> </ol>	
Remove linking	Close one of the panes. Click <b>Explore &gt; Remove Link.</b>	
Delete a pane	Select the graph. Click <b>Window &gt; Delete Pane.</b>	
Lock a pane	Select the graph. Click <b>Window &gt; Lock Panes.</b>	
Hide a pane	Select the graph. Click <b>Window &gt; Hide Pane.</b>	
Maximize a pane	Select the graph. Click <b>Window &gt; Maximize Pane.</b>	
Tile panes	Select the graph. Click <b>Window &gt; Tile all Panes.</b>	

## Zoom In on the Y-axis

1. Move the pointer to the left of the Y-axis on either side of the area to be expanded and then drag away from the starting point in a vertical direction while holding the left mouse button. A box is drawn along the Y-axis representing the new scale.

---

**Note:** Take care when zooming in on the baseline. Zoom in too far and the zoom-in box closes.

---

2. Release the mouse button to draw the graph to the new scale.

---

**Tip!** To return the Y-axis of the graph to the original scale, double-click either axis. To return the entire graph to the original scale, click **Explore > Home Graph**.

---

## Zoom In on the X-axis

1. Move the pointer under the X-axis to either side of the area to be expanded and then drag away from the starting point in a horizontal direction while holding the left mouse button.
2. Release the mouse button to draw the graph to the new scale.

---

**Tip!** To return the X-axis of the graph to the original scale, double-click the X-axis. To return the entire graph to the original scale, click **Explore > Home Graph**.

---

# Service and Maintenance Information

# 10

Regularly clean and maintain the system for optimal performance.



---

**WARNING! Electrical Shock Hazard. Do not remove the covers. Removing the covers might cause injury or malfunctioning of the system. The covers need not be removed for routine maintenance, inspection, or adjustment. Contact a SCIEX Field Service Employee (FSE) for repairs that require the covers to be removed.**

---



---

**WARNING! Ionizing Radiation Hazard, Biohazard, or Toxic Chemical Hazard. Determine whether decontamination is required before cleaning or maintenance. If radioactive materials, biological agents, or toxic chemicals have been used with the system, then the customer must decontaminate the system before cleaning or maintenance.**

---

## Recommended Maintenance Schedule

The following tables provide a recommended schedule for cleaning and maintaining the system.

---

**Tip!** Perform maintenance tasks regularly to make sure that the system is performing optimally.

---

- Perform periodic gas leakage tests and general maintenance inspections to be sure of safe operation of the system.
- Clean the system regularly to keep it in good working condition.
- During system maintenance, carefully inspect parts of the external gas supply system, including tubing connected to the equipment, to confirm that the condition is satisfactory. Replace any cracked, pinched, or collapsed tubing.

For information on maintaining the ion source, refer to the document: *DuoSpray Ion Source Operator Guide*.

To determine how often to clean or perform maintenance on the mass spectrometer and ion source, consider the following factors. These factors can cause changes in mass spectrometer performance, indicating that maintenance is required.

- Compounds tested
- Cleanliness of the samples and the sample preparation methods

- Amount of time that the probe is exposed to the sample
- Overall system run time

To order consumable parts and for basic service and maintenance requirements, contact a QMP or refer to the document: *Parts and Equipment Guide*. Contact a SCIEX FSE for all other service and maintenance requirements.

**Table 10-1 Mass Spectrometer Maintenance Tasks**

Component	Frequency	Task	For More Information
System	Daily	Inspect for leaks	Refer to the section: <a href="#">Chemical Precautions</a> .
Curtain plate	Daily	Clean	Refer to the section: <a href="#">Clean the Curtain Plate</a> .
Roughing pump oil	Weekly	Inspect the level	Refer to the section: <a href="#">Inspect the Roughing Pump Oil Level</a> . Contact the local QMP or FSE to add oil, if required.
Roughing pump oil	Every 3 years, or as needed.	Replace	Contact the local QMP or FSE.
Roughing pump oil	As needed	Refill	Contact the local QMP or FSE.
Orifice plate (front)	As needed	Clean	Refer to the section: <a href="#">Clean the Front of the Orifice Plate</a> .
Orifice plate (front and back)	As needed	Clean	Contact the local QMP or FSE.
QJet ion guide	As needed	Clean	Contact the local QMP or FSE.
Q0 rod set and IQ1 lens	As needed	Clean	Contact the local QMP or FSE.
Instrument surfaces	As needed	Clean	Refer to the section: <a href="#">Clean the Surfaces</a> .
Source exhaust drain bottle	As needed	Empty	Refer to the section: <a href="#">Empty the Source Exhaust Drain Bottle</a> .
Interface heater	As needed	Replace	Contact the local QMP or FSE.

**Table 10-2 Ion Source Maintenance Tasks**

Component	Frequency	Task	For More Information
TurbolonSpray and APCI probes	As needed	Examine and replace	Refer to the document: <i>DuoSpray Ion Source Operator Guide</i> .

## Service and Maintenance Information

---

**Table 10-2 Ion Source Maintenance Tasks (continued)**

Component	Frequency	Task	For More Information
MICRO 1–50 µL, MICRO 50–200 µL, and NANO probes (OptiFlow Turbo V ion source)	As needed	Examine and replace	Refer to the the document: <i>OptiFlow Turbo V Ion Source Operator Guide</i> .
Electrodes for the TurbolonSpray and APCI probes	As needed	Examine and replace	Refer to the document: <i>DuoSpray Ion Source Operator Guide</i> .
Electrodes for the probes for the OptiFlow Turbo V ion source	As needed	Examine and replace	Refer to the document: <i>OptiFlow Turbo V Ion Source Operator Guide</i> .
Corona discharge needle	As needed	Replace	Refer to the document: <i>DuoSpray Ion Source Operator Guide</i> .
Turbo heater	As needed	Replace	Contact the local QMP or FSE.
Turbo heater	As needed	Replace	Contact the local QMP or FSE.
Sample tubing	As needed	Replace	Refer to the document: <i>DuoSpray Ion Source Operator Guide</i> .

For “As needed” tasks, follow these guidelines:

- Clean the mass spectrometer surfaces after a spill or when they become dirty.
- Empty the source exhaust drain bottle before it becomes full.
- Clean the orifice plate, QJet ion guide, and Q0 region if system sensitivity degrades.

---

**Tip!** Clean the Q0 region regularly to minimize the impact of charging, a significant loss of sensitivity of the ions of interest over a short period of time, on the quadrupoles and lenses. Contact a QMP or FSE.

---

- Refill the roughing pump oil when it falls below the minimum oil level.
- Periodically inspect all exhaust connections to make sure that the integrity is maintained, and that any exhaust is removed from the customer lab.

## Clean the Surfaces

Clean the external surfaces of the mass spectrometer after a spill or when they become dirty.

---

**CAUTION: Potential System Damage. Use only the recommended cleaning methods and materials to avoid damaging the equipment.**

---

1. Wipe the external surfaces with a soft cloth dampened with warm, soapy water.
2. Wipe the external surfaces with a soft cloth dampened with water to remove any soap residue.

## Clean the Front-End

The following warning applies to all of the procedures in this section:



---

**WARNING! Hot Surface Hazard. Let the DuoSpray ion source cool for at least 20 minutes before starting any maintenance procedures. Some surfaces of the ion source and vacuum interface become hot during operation.**

---

Clean the mass spectrometer front-end using the routine cleaning method, to:

- Minimize unscheduled system downtime.
- Maintain optimum sensitivity.
- Avoid more extensive cleaning that requires a service visit.

When contamination occurs, perform an initial routine cleaning. Clean up to and including the front of the orifice plate. If routine cleaning does not resolve issues with sensitivity, then a full cleaning might be necessary.

This section provides instructions for performing routine cleaning without breaking vacuum.

---

**Note:** Follow all of the applicable local regulations. For health and safety guidelines, refer to the section: [Chemical Precautions](#).

---

## Symptoms of Contamination

The system might be contaminated if any one of the following is observed:

- Significant loss in sensitivity
- Increased background noise
- Additional peaks that are not part of the sample in full scan or survey scan methods

If any of these issues are observed, then clean the mass spectrometer front-end.

## Service and Maintenance Information

---

### Required Materials

---

**Note:** U.S. customers can call 877-740-2129 for ordering information and inquiries. International customers can visit [sciex.com/contact-us](http://sciex.com/contact-us).

---

- Powder-free gloves, nitrile or neoprene recommended
- Safety glasses
- Laboratory coat
- Fresh LC-MS-grade water. Old water can contain contaminants that can further contaminate the mass spectrometer.
- LC-MS-grade methanol, isopropanol (2-propanol), or acetonitrile
- Cleaning solution. Use one of:
  - 100% methanol
  - 100% isopropanol
  - 1:1 acetonitrile:water solution, freshly prepared
  - 1:1 acetonitrile:water with 0.1% acetic acid solution, freshly prepared
- Clean 1 L or 500 mL glass beaker to prepare cleaning solutions
- 1 L beaker to catch used solvent
- Organic waste container
- Lint-free wipes. Refer to the section: [Tools and Supplies Available from the Manufacturer](#).
- (Optional) Polyester (poly) swabs

### Tools and Supplies Available from the Manufacturer

**Table 10-3**

Description	Part Number
Small poly swab, thermally bonded. Also available in the Cleaning kit.	1017396
Lint-free wipe (11 cm x 21 cm, 4.3 inches x 8.3 inches). Also available in the Cleaning kit.	018027
Cleaning kit. Contains the small poly swab, lint-free wipes, Q0 cleaning tool, tapered QJet ion guide cleaning brush, and Alconox.	5020763



## Cleaning Best Practices



**WARNING! Hot Surface Hazard.** Let the DuoSpray ion source cool for at least 20 minutes before starting any maintenance procedures. Some surfaces of the ion source and vacuum interface become hot during operation.

---



**WARNING! Toxic Chemical Hazard.** Refer to the chemical product safety data sheets and follow all of the recommended safety procedures when handling, storing, and disposing of chemicals.

---



**WARNING! Ionizing Radiation Hazard, Biohazard, or Toxic Chemical Hazard.** Determine whether decontamination is required before cleaning or maintenance. If radioactive materials, biological agents, or toxic chemicals have been used with the system, then the customer must decontaminate the system before cleaning or maintenance.

---



**WARNING! Environmental Hazard.** Do not dispose of system components in municipal waste. Follow local regulations when disposing of components.

---

- Allow the ion source to cool before removing it.
- Always wear clean, powder-free gloves, nitrile or neoprene recommended, for the cleaning procedures.
- After cleaning the mass spectrometer components, and before reassembling them, put on a new, clean pair of gloves.
- Do not use cleaning supplies other than those specified in this procedure.
- If possible, prepare cleaning solutions just before cleaning.
- Prepare and store all of the organic solutions and organic-containing solutions in very clean glassware only. Never use plastic bottles. Contaminants can leach from these bottles and further contaminate the mass spectrometer.
- To avoid contaminating the cleaning solution, pour the solution on the wipe or swab.
- Allow only the center area of the wipe to contact the mass spectrometer surface. Cut edges can leave fibers behind.

---

**Tip!** Wrap the wipe around a thermally-bonded poly swab.

---

**Figure 10-1 Example: Folding the Wipe**



- To avoid cross-contamination, discard the wipe or swab after it has touched the surface once.
- If required, perform multiple cleanings, using multiple wipes for larger parts of the vacuum interface, such as the curtain plate.
- Only dampen the wipe or swab slightly when applying water or cleaning solution. Water, more often than organic solvents, might cause the wipe to deteriorate, leaving residue on the mass spectrometer.
- Do not rub the wipe across the aperture. Wipe around the aperture to prevent fibers from the wipes from entering the mass spectrometer.
- Do not insert the brush in the aperture on the curtain plate or orifice plate.

## Prepare the Mass Spectrometer



---

**WARNING! Hot Surface Hazard. Let the DuoSpray ion source cool for at least 20 minutes before starting any maintenance procedures. Some surfaces of the ion source and vacuum interface become hot during operation.**

---

**CAUTION: Potential System Damage. Do not drop anything in the source drain when the ion source is removed.**

**Figure 10-2 Source Drain on the Vacuum Interface**

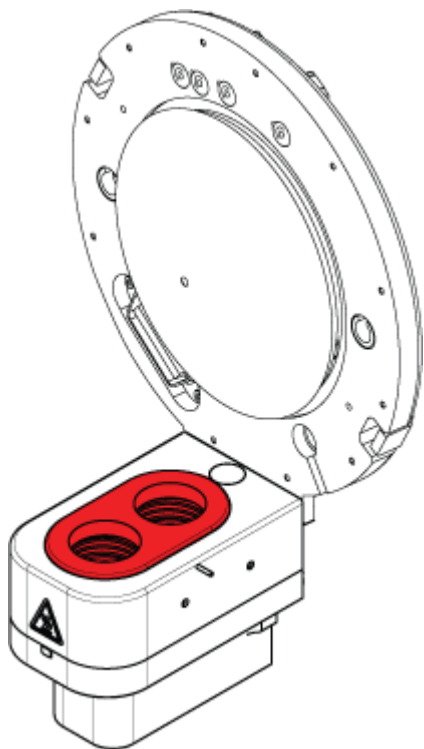

---

**Note:** Mass spectrometers with a NanoSpray ion source might require a full cleaning for best results. Contact a local QMP or an FSE.

---

1. Deactivate the hardware profile. Refer to the document: *Software User Guide*.
2. Remove the ion source. Refer to the ion source document: *Operator Guide*.  
When the ion source is not in use, store it to protect it from damage and to maintain operating integrity.

## Clean the Curtain Plate

---

**CAUTION: Potential System Damage. Do not rest the curtain plate or orifice plate on the aperture tip. Make sure that the conical side of the curtain plate faces up.**

---

**CAUTION: Potential System Damage. To avoid damaging the aperture, do not insert a wire or metal brush in the aperture on the curtain plate, orifice plate, or interface heater.**

---

## Service and Maintenance Information

---

1. Pull the curtain plate off of the vacuum interface and then put it, conical side up, on a clean, stable surface.

---

**Note:** If the nano cell heater assembly is installed, then follow the instructions in the *Operator Guide* for the ion source to remove and clean it.

---

**Figure 10-3 Curtain Plate Removal**

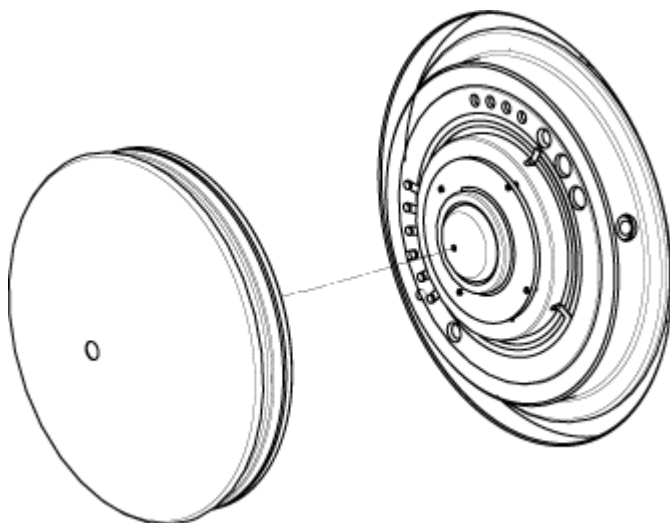

The curtain plate is held in place by three retaining ball catches mounted on the orifice plate.

---

**Tip!** If the curtain plate does not immediately separate from the orifice plate, then turn the curtain plate slightly, less than 90 degrees, to release the ball spring latches.

---

2. Dampen a lint-free wipe with LC-MS-grade water and then clean both sides of the curtain plate.

---

**Note:** Use multiple wipes, as required.

---

3. Repeat step 2 using the cleaning solution.
4. Using a dampened wipe or small poly swab, clean the aperture.
5. Wait until the curtain plate is dry.
6. Inspect the curtain plate for solvent stains or lint, removing any residue with a clean, slightly damp, lint-free wipe.

---

**Note:** Persistent spotting or filming is an indicator of contaminated solvent.

---

## Clean the Front of the Orifice Plate

---

**CAUTION: Potential System Damage.** When cleaning the surface of the orifice plate, do not remove the interface heater. Frequent removal of the interface heater can result in damage to the interface heater. Surface cleaning of the interface heater is adequate for routine cleaning.

---

**CAUTION: Potential System Damage.** To avoid damaging the aperture, do not insert a wire or metal brush in the aperture on the curtain plate, orifice plate, or interface heater.

---

1. Dampen a lint-free wipe with LC-MS-grade water and then wipe the front of the orifice plate, including the interface heater.
  2. Repeat step 1 using the cleaning solution.
  3. Wait until the orifice plate is dry.
  4. Inspect the orifice plate for solvent stains or lint, removing any residue with a clean, slightly damp, lint-free wipe.
- 

**Note:** Persistent spotting or filming is an indicator of contaminated solvent.

---

## Put the Mass Spectrometer Back in Service

1. Install the curtain plate.
2. Install the ion source on the mass spectrometer. Refer to the ion source document: *Operator Guide*.  
Tighten the ion source by turning the source latches down in the locking position.
3. Activate the hardware profile. Refer to the document: *Software User Guide*.

## Empty the Source Exhaust Drain Bottle



**WARNING! Hot Surface Hazard.** Let the DuoSpray ion source cool for at least 20 minutes before starting any maintenance procedures. Some surfaces of the ion source and vacuum interface become hot during operation.

---



**WARNING! Ionizing Radiation Hazard, Biohazard, or Toxic Chemical Hazard.** Deposit hazardous materials in appropriately labeled waste containers and dispose of them according to local regulations.

---

## Service and Maintenance Information

---



**WARNING! Ionizing Radiation Hazard, Biohazard, or Toxic Chemical Hazard. Take care to vent exhaust gases to a dedicated laboratory fume hood or exhaust system and make sure that the ventilation tubing is secured with clamps. Make sure that the laboratory has appropriate air exchange for the work performed.**

---

**Note:** Make sure that there are no kinks, sags, or twists in the source waste line.

---

Inspect the source exhaust drain bottle regularly, and empty it before it becomes full. Also inspect the bottle and the fitting for leaks, and tighten connections or replace components, if required. Follow the steps in this procedure to empty the bottle.

1. Remove the ion source. Refer to the document: *DuoSpray Ion Source Operator Guide*.
2. Loosen the clamps connecting the hoses to the cap of the source exhaust drain bottle.

Figure 10-4 Source Exhaust Drain Bottle

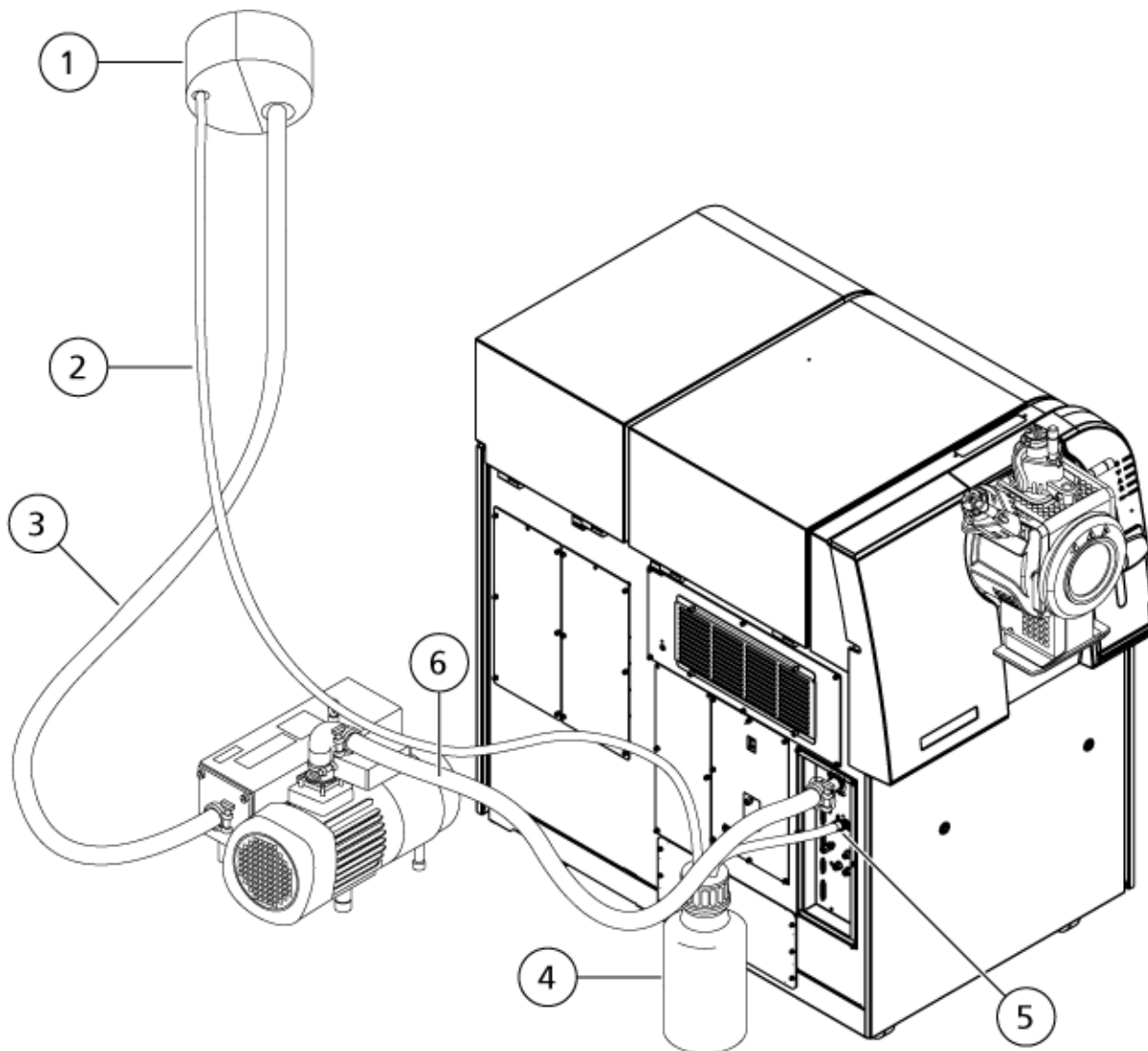

Item	Description
1	Connection to vent
2	Source exhaust drain tubing: 2.5 cm (1.0 inch) inner diameter (i.d.)
3	Roughing pump exhaust hose: 3.2 cm (1.25 inch) i.d.

## Service and Maintenance Information

---

Item	Description
4	Source exhaust drain bottle In this drawing, the capped drain bottle is shown at the back of the mass spectrometer to make connection points visible. The drain bottle might be located at the side of the mass spectrometer in the drain bottle holder. Make sure that the bottle is secured to prevent spillage.
5	Source exhaust connection to the mass spectrometer: 1.6 cm (0.625 inch) i.d.
6	Roughing pump vacuum inlet hose.

---

**Note:** Source exhaust hose connections at the drain bottle, mass spectrometer, and the lab vent are secured with hose clamps.

---

3. If applicable, lift the drain bottle out of the holder.
4. Disconnect the hoses from the cap.
5. Remove the cap from the drain bottle.
6. Empty the drain bottle and then dispose of the waste according to laboratory procedures and local waste regulations.
7. Install the cap on the bottle and then put the bottle in the holder.
8. Attach the hoses to the cap and then secure them tightly with clamps.

## Inspect the Roughing Pump Oil Level

Inspect the sight glass on the roughing pump to verify that the oil is above the minimum level.

If the oil is below the minimum level, then contact the Qualified Maintenance Person (QMP) or SCIEX Field Service Employee (FSE).



**Figure 10-5 Sight Glass**

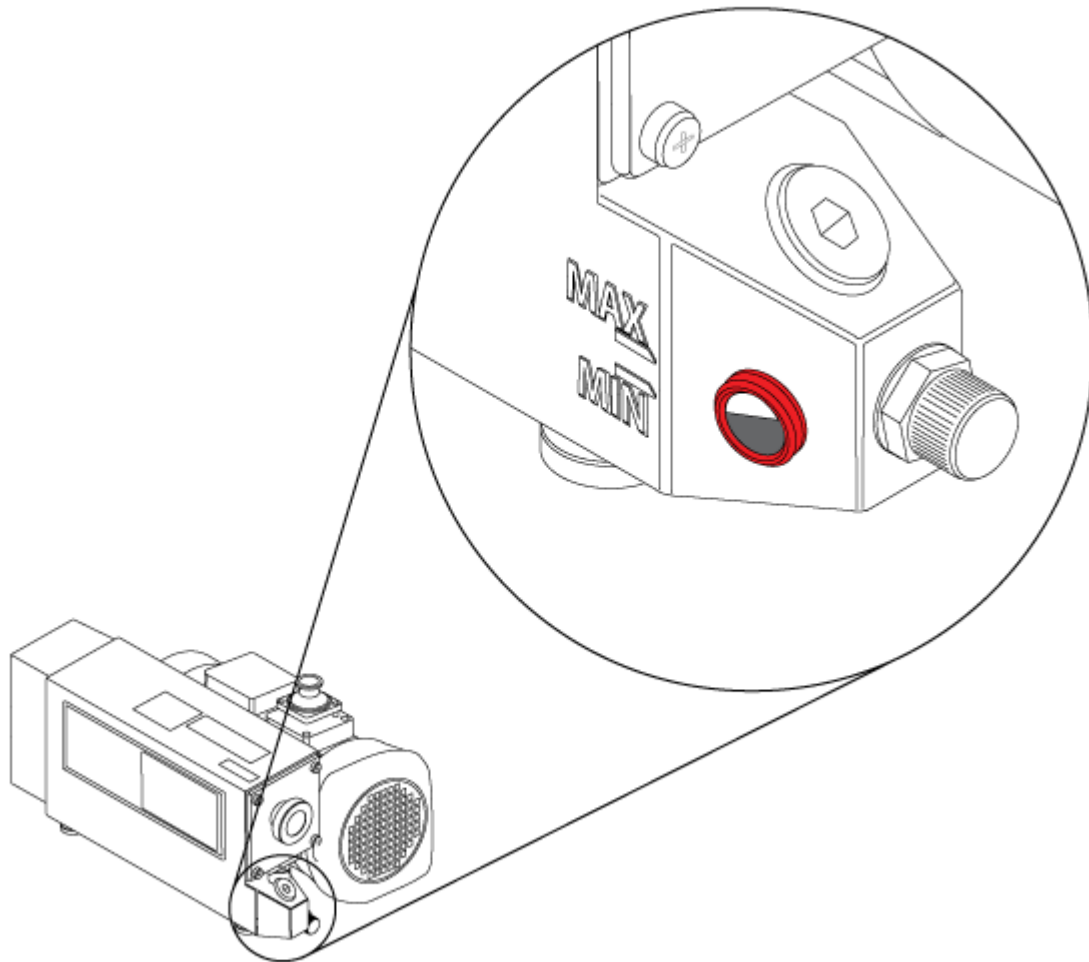

## **Replace the Mass Spectrometer Cooling Fans Filter**

The mass spectrometer cooling fans are on the left side of the mass spectrometer.

## Service and Maintenance Information

---

### Prerequisite Procedures

- Shut down the system by following the procedure in the *System User Guide*.



**WARNING! Environmental Hazard. Do not dispose of system components in municipal waste. Follow local regulations when disposing of components.**

---

1. Remove the four thumbscrews on the cooling fan cover.

**Figure 10-6 Cooling Fan Filters**

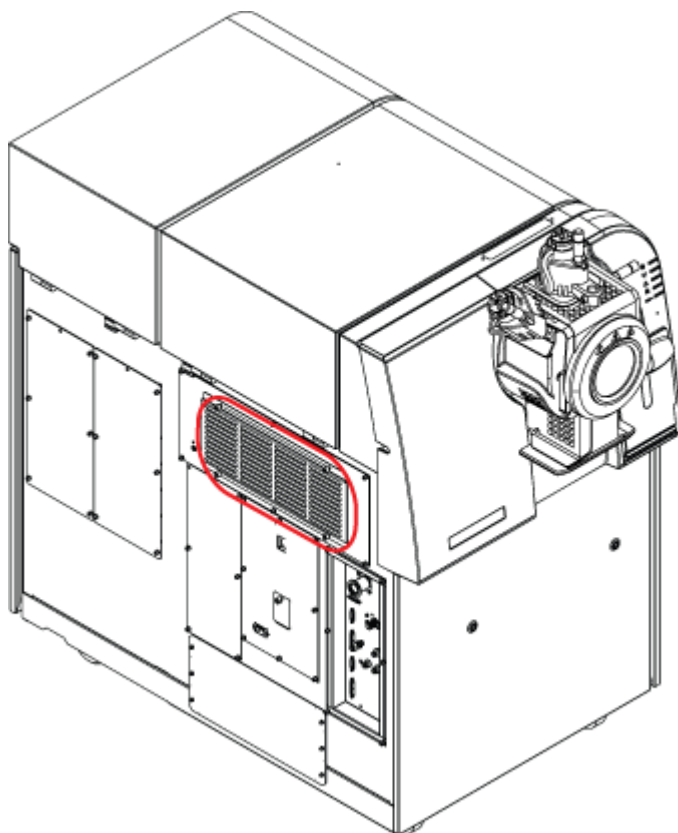

2. Remove the filter and then replace it with a new one.

Figure 10-7 Cooling Fans Filter

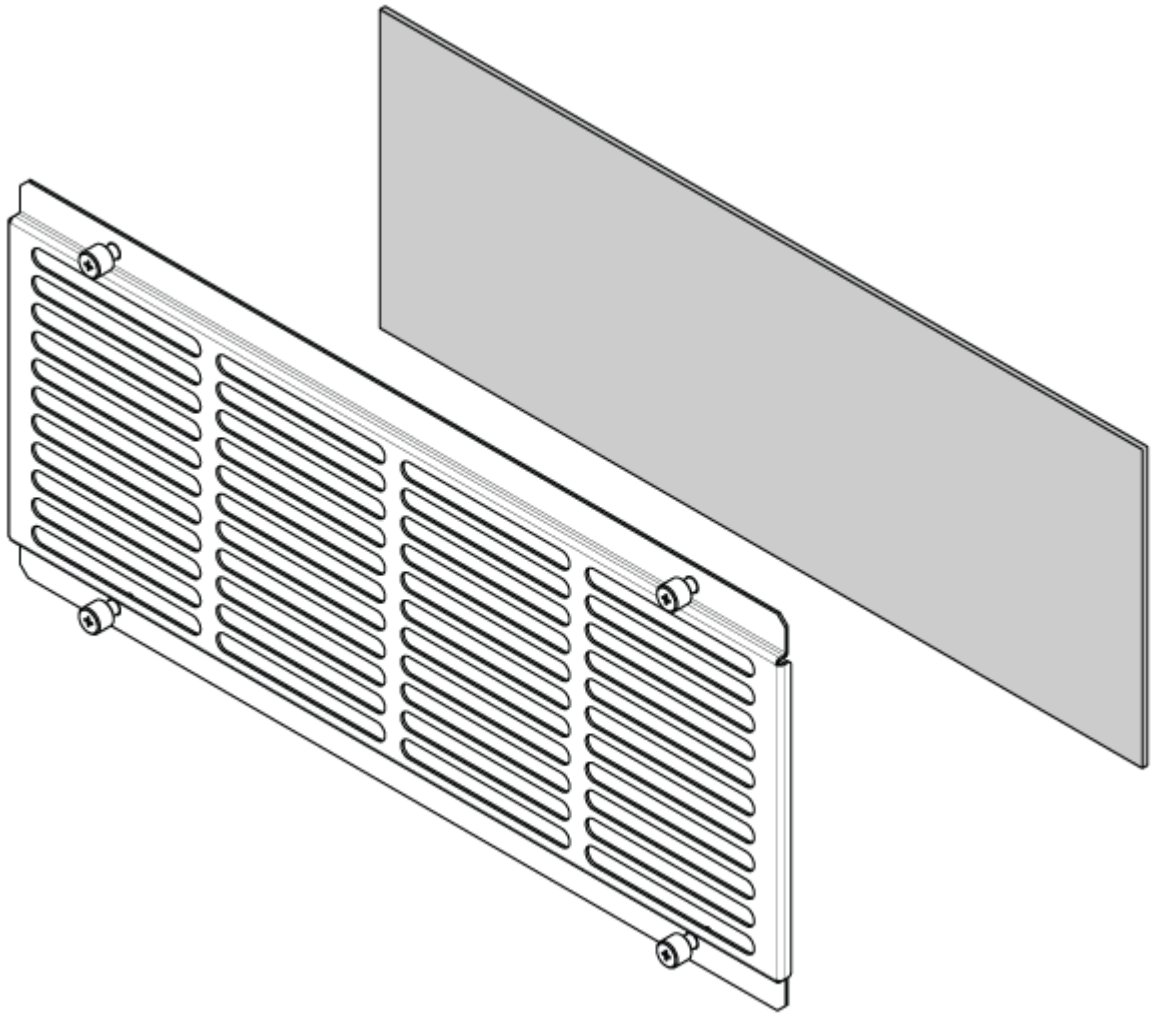

Item	Description
1	Cooling fans cover
2	Filter

3. Install the filter cover.

## Storage and Handling



**WARNING! Environmental Hazard.** Do not dispose of system components in municipal waste. Follow local regulations when disposing of components.

## Service and Maintenance Information

---

If the mass spectrometer must be stored for a long time or prepared for shipping, then contact a SCIEX FSE for decommissioning information. To disconnect power from the mass spectrometer, remove the mains supply connector from the AC mains supply.

---

**Note:** The ion source and mass spectrometer must be transported and stored at a temperature between  $-30\text{ }^{\circ}\text{C}$  to  $+60\text{ }^{\circ}\text{C}$  ( $-22\text{ }^{\circ}\text{F}$  to  $140\text{ }^{\circ}\text{F}$ ) and relative humidity not exceeding 99%, non-condensing. Store the system at an altitude not exceeding 2,000 m (6,562 feet) above sea level.

---

# Mass Spectrometer Troubleshooting 11

---

This section contains information for troubleshooting basic system issues. Certain activities can only be carried out by a SCIEX-trained Qualified Maintenance Person (QMP) in the laboratory. For advanced troubleshooting, contact a SCIEX Field Service Employee (FSE).

**Table 11-1 System Issues**

Symptom	Possible Cause	Corrective Action
The QJet ion guide is extremely dirty or frequently becomes dirty.	The flow rate of the gas for the Curtain Gas interface is too low.	Examine the setting for the gas for the Curtain Gas interface and increase it, if applicable.
A system fault has occurred because the vacuum pressure is too high.	<ol style="list-style-type: none"><li>1. The oil level is too low.</li><li>2. There is a leak.</li><li>3. The wrong orifice plate is installed.</li></ol>	<ol style="list-style-type: none"><li>1. Inspect the oil level in the roughing pump, and then contact the local QMP or an FSE to add oil. Refer to the section: <a href="#">Inspect the Roughing Pump Oil Level</a>.</li><li>2. Inspect and repair leaks.</li><li>3. Install the correct orifice plate.</li></ol>
A system fault has occurred because the QPS exciter module temperature is too high.	<ol style="list-style-type: none"><li>1. Ambient temperature is too high.</li></ol>	<ol style="list-style-type: none"><li>1. Contact the local QMP or FSE.</li><li>2. For the ambient temperature specifications, refer to the document: <i>Site Planning Guide</i> for the system.</li></ol>

## Mass Spectrometer Troubleshooting

---

**Table 11-1 System Issues (continued)**

Symptom	Possible Cause	Corrective Action
The control software reports that the mass spectrometer is in Fault status because of the ion source.	<ol style="list-style-type: none"> <li>1. The probe is not installed.</li> <li>2. The probe is not connected securely.</li> </ol>	<p>Confirm the fault in the Status panel of the device details page.</p> <ol style="list-style-type: none"> <li>1. Install the probe. Refer to the document: <i>DuoSpray Ion Source Operator Guide</i>.</li> <li>2. Remove and then install the probe. Tighten the retaining ring securely. Refer to the document: <i>DuoSpray Ion Source Operator Guide</i>.</li> </ol>
The control software indicates that the APCI probe is in use, but the TurbolonSpray probe is installed.	The F3 fuse is blown.	Contact an FSE.
The spray is not uniform.	The electrode is blocked.	Clean or replace the electrode. Refer to the document: <i>DuoSpray Ion Source Operator Guide</i> .
The interface heater is not ready.	The interface heater is faulty.	Contact the local QMP or FSE.
The mass spectrometer resolution is poor.	The mass spectrometer is not tuned.	Use the Instrument Optimization wizard to optimize the mass spectrometer. Refer to the <i>Software User Guide</i> or Help System.

Table 11-1 System Issues (continued)

Symptom	Possible Cause	Corrective Action
The mass spectrometer performance has degraded.	<ol style="list-style-type: none"> <li>1. The ion source conditions are not optimized.</li> <li>2. The sample was not prepared correctly or the sample has degraded.</li> <li>3. The sample inlet fittings are leaking.</li> </ol>	<ol style="list-style-type: none"> <li>1. Optimize the ion source conditions. Refer to the document: <i>DuoSpray Ion Source Operator Guide</i>.</li> <li>2. Confirm that the sample was prepared correctly.</li> <li>3. Verify that the fittings are the right size and type and make sure that they are tight. Do not overtighten the fittings. Replace the fittings if leaks continue.</li> <li>4. Install and optimize an alternate ion source.</li> <li>5. Contact an FSE if the issue persists.</li> </ol>
Arcing or sparks occur.	The position of the corona discharge needle is incorrect.	If the TurbolonSpray probe is being used, then turn the corona discharge needle toward the curtain plate and away from the stream of heater gas. Refer to the document: <i>DuoSpray Ion Source Operator Guide</i> .

Table 11-2 Sensitivity Issues

Possible Cause	Corrective Action
<b>Sensitivity is Decreased</b>	
The ion source parameters are not optimized.	Optimize the ion source parameters.
The mass spectrometer is not optimized.	Use the Instrument Optimization wizard to optimize the mass spectrometer.
The curtain plate is dirty.	Clean the curtain plate. Refer to the section: <a href="#">Clean the Curtain Plate</a> .

## Mass Spectrometer Troubleshooting

**Table 11-2 Sensitivity Issues (continued)**

Possible Cause	Corrective Action
The orifice plate is dirty.	Refer to the section: <a href="#">Clean the Front of the Orifice Plate</a> or contact the local QMP or FSE.
The QJet ion guide or IQ0 lens is dirty.	Clean the QJet ion guide and IQ0 lens. Contact the local QMP or FSE.
Q0 region is dirty.	Test for contamination of the Q0 region. Contact the local QMP or FSE.
The sample has degraded or has a low concentration.	Verify the sample concentration. Use a fresh sample.
The probe is not installed properly.	Remove and install the probe.
The ion source is not installed properly or it is faulty.	Remove and install the ion source, making sure that the latches are properly secured. If this does not resolve the issue, then install and optimize an alternate ion source.
One or more of the O-rings on the vacuum interface is missing.	If the O-rings are on the ion source, then install them on the vacuum interface. If they are missing, then replace them.
There is an issue with the LC system or connections.	Troubleshoot the LC system.
The Declustering Potential (DP) is not optimized.	Optimize DP.
The electrode is dirty or blocked.	Replace the electrode. Refer to the document: <i>DuoSpray Ion Source Operator Guide</i> .
<b>There is No Signal or the Signal is Unstable</b>	
The tubing is blocked.	Replace the sample tubing.

**Table 11-3 Background Noise Issues**

Possible Cause	Corrective Action
The <b>Temperature (TEM)</b> , IonSpray voltage (IS) or heater gas flow rate (GS2) is too high.	Optimize the ion source parameters. Refer to the document: <i>DuoSpray Ion Source Operator Guide</i> .
The curtain plate is dirty.	Clean the curtain plate. Refer to the section: <a href="#">Clean the Curtain Plate</a> .



Table 11-3 Background Noise Issues (continued)

Possible Cause	Corrective Action
The orifice plate is dirty.	Clean the front of the orifice plate. Refer to the section: <a href="#">Clean the Front of the Orifice Plate</a> .
The QJet ion guide or IQ0 lens is dirty.	Do a full cleaning of the front end components of the mass spectrometer. Contact the local QMP or FSE.
The Q0 region is dirty.	Clean the Q0 region. Contact the QMP or FSE.
Mobile phase is contaminated.	Replace the mobile phase.
The ion source is contaminated.	<p>Clean or replace the ion source components and then condition the ion source and front end:</p> <ol style="list-style-type: none"> <li>1. Move the probe to the furthest position from the aperture, vertically and horizontally.</li> <li>2. (Analyst TF software) Make sure that the interface heater is on.</li> <li>3. Infuse or inject 50:50 methanol:water with a pump flow rate of 1 mL/min.</li> <li>4. In the control software, set the temperature to 650, ion source gas 1 to 60, and ion source gas 2 to 60.</li> <li>5. Set the flow rate for the gas for the Curtain Gas interface to 45 or 50.</li> <li>6. Run for a minimum of 2 hours or preferably overnight for best results.</li> </ol>

For sales, technical assistance, or service, contact an FSE or visit the SCIEX website at [sciex.com](http://sciex.com) for contact information.

# Recommended Calibration Ions

# A

**CAUTION: Potential Wrong Result. Do not use expired solutions or solutions that have not been stored at the indicated storage temperature.**

The following tables list the standards recommended by SCIEX for calibrating the TripleTOF 6600+ system. For information about tuning solutions, refer to [Operating Instructions — Tune and Calibrate](#).

**Table A-1 Q1 PPG Positive Calibration Ions**

Masses								
59.0491 4	233.174 72	442.337 40	674.504 84	906.672 28	1196.881 58	1545.13 274	1952.42 576	2242.63 506

**Table A-2 Q1 PPG Negative Calibration Ions**

Masses								
44.9981 9	411.2599 1	585.385 49	933.636 65	1165.804 09	1572.09 711	1863.30 641	1979.39 013	2211.557 57

**Table A-3 APCI Positive Calibration Solution and ESI Positive Calibration Solution: TOF MS**

TOF MS	Masses
aminoheptanoic acid	146.11756
amino-dPEG 4-acid	266.15981
clomipramine	315.16225
amino-dPEG 6-acid	354.21224
amino-dPEG 8-acid	442.26467
reserpine	609.28066
amino-dPEG 12-acid	618.36953
Hexakis (2,2,3,3-tetrafluoropropoxy) phosphazene	922.0098

**Table A-3 APCI Positive Calibration Solution and ESI Positive Calibration Solution: TOF MS (continued)**

TOF MS	Masses
Hexakis (1H,1H,5H-octafluoropentoxy) phosphazene	1521.97148

**Table A-4 APCI Positive Calibration Solution and ESI Positive Calibration Solution: MSMS (Clomipramine)**

MSMS (Clomipramine)	Masses
C <sub>3</sub> H <sub>8</sub> N	58.0651
C <sub>5</sub> H <sub>12</sub> N	86.0964
C <sub>16</sub> H <sub>14</sub> N	220.1121
C <sub>14</sub> H <sub>10</sub> NCl	227.0496
C <sub>17</sub> H <sub>17</sub> N	235.1356
C <sub>15</sub> H <sub>13</sub> NCl	242.0731
C <sub>17</sub> H <sub>17</sub> ClN	270.1044
C <sub>19</sub> H <sub>23</sub> ClN <sub>2</sub>	315.16225

**Table A-5 APCI Negative Calibration Solution and ESI Negative Calibration Solution: TOF MS**

TOF MS	Masses
7-aminoheptanoic acid	144.103
amino-dPEG 4-acid	264.14526
sulfinpyrazone fragment	277.09825
amino-dPEG 6-acid	352.19769
sulfinpyrazone	403.11219
amino-dPEG 8-acid	440.25012
amino-dPEG 12-acid	616.35498
amino-dPEG 16-acid	792.45984

## Recommended Calibration Ions

---

**Table A-6 APCI Negative Calibration Solution and ESI Negative Calibration Solution:  
MSMS (Sulfinpyrazone)**

<b>MSMS (Sulfinpyrazone)</b>	<b>Masses</b>
C <sub>6</sub> H <sub>5</sub> O	93.0344
C <sub>6</sub> H <sub>5</sub> OS	125.0067
C <sub>10</sub> H <sub>8</sub> NO	158.06114
C <sub>17</sub> H <sub>13</sub> N <sub>2</sub> O <sub>2</sub>	277.0983
C <sub>23</sub> H <sub>2</sub> ON <sub>2</sub> OS <sub>3</sub>	403.11219

**Table A-7 APCI Negative Calibration Solution and ESI Negative Calibration Solution:  
MSMS (Sulfinpyrazone Fragment)**

<b>MSMS (Sulfinpyrazone Fragment)</b>	<b>Masses</b>
C <sub>6</sub> H <sub>5</sub>	77.03967
C <sub>8</sub> H <sub>6</sub> N	116.0506
C <sub>9</sub> H <sub>8</sub> N	130.0662
C <sub>10</sub> H <sub>8</sub> NO	158.0611
C <sub>11</sub> H <sub>8</sub> N <sub>2</sub> O <sub>2</sub>	200.0591
C <sub>15</sub> H <sub>9</sub> N <sub>2</sub>	217.0771
C <sub>16</sub> H <sub>13</sub> N <sub>2</sub> O	249.1033
C <sub>17</sub> H <sub>13</sub> N <sub>2</sub> O <sub>2</sub>	277.09825

# Exact Masses and Chemical Formulas

# B

## PPG

Table B-1 contains the exact monoisotopic masses and charged species (positive and negative) observed with the PPG (polypropylene glycol) calibration solutions. The masses and ions were calculated using the formula  $M = H[OC_3H_6]_nOH$ , while the positive ion MSMS fragments used the formula,  $[OC_3H_6]_n(H^+)$ . In all calculations, H = 1.007825, O = 15.99491, C = 12.00000, and N = 14.00307.

**Note:** When performing calibrations with the PPG solutions, use the correct isotope peak.

**Table B-1 PPG Exact Masses**

n	Exact Mass (M)	(M + NH <sub>4</sub> ) <sup>+</sup>	MSMS Fragments	(M + NH <sub>4</sub> ) <sup>2+</sup>	(M + COOH) <sup>-</sup>
1	76.05242	94.08624	59.04914	56.06003	121.05061
2	134.09428	152.12810	117.09100	85.08096	179.09247
3	192.13614	210.16996	175.13286	114.10189	237.13433
4	250.17800	268.21182	233.17472	143.12282	295.17619
5	308.21986	326.25368	291.21658	172.14375	353.21805
6	366.26172	384.29554	349.25844	201.16468	411.25991
7	424.30358	442.33740	407.30030	230.18561	469.30177
8	482.34544	500.37926	465.34216	259.20654	527.34363
9	540.38730	558.42112	523.38402	288.22747	585.38549
10	598.42916	616.46298	581.42588	317.24840	643.42735
11	656.47102	674.50484	639.46774	346.26933	701.46921
12	714.51288	732.54670	697.50960	375.29026	759.51107
13	772.55474	790.58856	755.55146	404.31119	817.55293
14	830.59660	848.63042	813.59332	433.33212	875.59479
15	888.63846	906.67228	871.63518	462.35305	933.63665
16	946.68032	964.71414	929.67704	491.37398	991.67851

## Exact Masses and Chemical Formulas

---

**Table B-1 PPG Exact Masses (continued)**

n	Exact Mass (M)	(M + NH <sub>4</sub> ) <sup>+</sup>	MSMS Fragments	(M + NH <sub>4</sub> ) <sup>2+</sup>	(M + COOH) <sup>-</sup>
17	1004.72218	1022.75600	987.71890	520.39491	1049.72037
18	1062.76404	1080.79786	1045.76076	549.41584	1107.76223
19	1120.80590	1138.83972	1103.80262	578.43677	1165.80409
20	1178.84776	1196.88158	1161.84448	607.45770	1223.84595
21	1236.88962	1254.92344	1219.88634	636.47863	1281.88781
22	1294.93148	1312.96530	1277.92820	665.49956	1339.92967
23	1352.9733	1371.0072	1335.9701	694.5205	1397.9715
24	1411.0152	1429.0490	1394.0119	723.5414	1456.0134
25	1469.0571	1487.0909	1452.0538	752.5624	1514.0553
26	1527.0989	1545.1327	1510.0956	781.5833	1572.0971
27	1585.1408	1603.1746	1568.1375	810.6042	1630.1390
28	1643.1826	1661.2165	1626.1794	839.6251	1688.1808
29	1701.2245	1719.2583	1684.2212	868.6461	1746.2227
30	1759.2664	1777.3002	1742.2631	897.6670	1804.2646
31	1817.3082	1835.3420	1800.3049	926.6879	1862.3064
32	1875.3501	1893.3839	1858.3468	955.7089	1920.3483
33	1933.3919	1951.4258	1916.3887	984.7298	1978.3901
34	1991.4338	2009.4676	1974.4305	1013.7507	2036.4320
35	2049.4757	2067.5095	2032.4724	1042.7717	2094.4739
36	2107.5175	2125.5513	2090.5142	1071.7926	2152.5157
37	2165.5594	2183.5932	2148.5561	1100.8135	2210.5576
38	2223.6012	2241.6351	2206.5980	1129.8344	2268.5994

## Reserpine

**Table B-2 Reserpine Exact Masses (C<sub>33</sub>H<sub>40</sub>N<sub>2</sub>O<sub>9</sub>)**

Description	Mass
Molecular Ion C <sub>33</sub> H <sub>41</sub> N <sub>2</sub> O <sub>9</sub>	609.28066
Fragment C <sub>23</sub> H <sub>30</sub> NO <sub>8</sub>	448.19659
Fragment C <sub>23</sub> H <sub>29</sub> N <sub>2</sub> O <sub>4</sub>	397.21218
Fragment C <sub>22</sub> H <sub>25</sub> N <sub>2</sub> O <sub>3</sub>	365.18597
Fragment C <sub>13</sub> H <sub>18</sub> NO <sub>3</sub>	236.12812
Fragment C <sub>10</sub> H <sub>11</sub> O <sub>4</sub>	195.06519
Fragment C <sub>11</sub> H <sub>12</sub> NO	174.09134

**Taurocholic Acid****Table B-3 Taurocholic Acid Exact Masses (C<sub>26</sub>H<sub>45</sub>NO<sub>7</sub>S)**

Description	Mass
Molecular Ion C <sub>26</sub> H <sub>44</sub> NO <sub>7</sub> S	514.28440
Fragment C <sub>2</sub> H <sub>3</sub> O <sub>3</sub> S	106.98084
Fragment C <sub>2</sub> H <sub>6</sub> NO <sub>3</sub> S	124.00739
Fragment SO <sub>3</sub>	79.95736

**TOF Calibration Solution****Table B-4 TOF Calibration Solution Exact Masses**

Description	Mass
Molecular Ion Cs <sup>+</sup>	132.90488
Molecular Ion Peptide ALILTLVS	829.53933

## Exact Masses and Chemical Formulas

---

### Peptide ALILTLVS

Table B-5 Peptide ALILTLVS Exact Mass

Name	Sequence	Mass	Charge State
Precursor Ion	ALILTLVS	829.5393	1+
b8	ALILTLVS	811.5288	1+
b7	ALILTLV	724.4967	1+
b7-18	ALILTLV	706.4862	1+
b6-18	ALILTLV	607.4178	1+
y5	LTLVS	532.3341	1+
b5	ALILT	512.3443	1+
b5-18	ALILT	494.3337	1+
b4	ALIL	411.2966	1+
b3	ALI	298.2125	1+
Internal fragment y b	IL or LI	227.1754	1+
Internal fragment y b	LT or TL	215.139	1+
b2	AL	185.1285	1+
a2	AL	157.1335	1+
Immonium Ions	I or L	86.09643	1+





# Toolbar Icons









# C

For additional toolbar icons, refer to the document: *Advanced User Guide*.

**Table C-1 Tool Bar Icons**

Icon	Name	Description
	<b>New Subproject</b>	Creates a subproject. Subprojects can only be created later in the process if the project was originally created with subprojects.
	<b>Copy Subproject</b>	Copies a subproject folder.  Subprojects can be copied only from another project that has existing subprojects. If the same folders exist at both the project and subproject levels, then the software uses the project level folders.

**Table C-2 Acquisition Method Editor Icons**

Icon	Name	Description
	<b>Mass Spec</b>	Shows the MS tab in the Acquisition Method editor.
	<b>Period</b>	Adds an experiment, an <b>IDA Criteria Level</b> , or deletes the period.
	<b>Autosampler</b>	Opens the Autosampler Properties tab.
	<b>Syringe Pump</b>	Opens the Syringe Pump Properties tab.
	<b>Column Oven</b>	Opens the Column Oven Properties tab.
	<b>Valve</b>	Opens the Valve Properties tab.
	<b>DAD</b>	Opens the DAD Method Editor. Refer to the section: <a href="#">Show DAD Data</a> .
	<b>ADC</b>	Opens the ADC Properties tab. Refer to the section: <a href="#">Show ADC Data</a> .

## Toolbar Icons

Table C-3 Acquire Mode Icons



























Icon	Name	Description
	<b>View Queue</b>	Shows the sample queue.
	<b>Instrument Queue</b>	Shows a remote instrument station.
	<b>Status for Remote Instrument</b>	Shows the status of a remote instrument.
	<b>Start Sample</b>	Starts the sample in the queue.
	<b>Stop Sample</b>	Stops the sample in the queue.
	<b>Abort Sample</b>	Aborts a sample acquisition in the middle of the processing of that sample.
	<b>Stop Queue</b>	Stops the queue before it has completed processing all of the samples.
	<b>Pause Sample Now</b>	Inserts a pause in the queue.
	<b>Insert Pause before Selected Sample(s)</b>	Inserts a pause before a specific sample.
	<b>Continue Sample</b>	Continues acquiring the sample.
	<b>Next Period</b>	Starts a new period.
	<b>Extend Period</b>	Extends the current period.
	<b>Next Sample</b>	Stops acquiring the current sample and starts acquiring the next sample.
	<b>Equilibrate</b>	Selects the method to be used to equilibrate the devices. This method should be the same as the method that was used with the first sample in the queue.
	<b>Standby</b>	Puts the instrument in <b>Standby</b> state.

Table C-3 Acquire Mode Icons (continued)

Icon	Name	Description
	<b>Ready</b>	Puts the instrument in <b>Ready</b> state.
	<b>Reserve Instrument for Tuning</b>	Reserves the mass spectrometer for tuning and calibrating.
	<b>Method Wizard</b>	Starts the <b>Method Wizard</b> .
	<b>Purge Modifier</b>	Starts the modifier purge from the modifier pump.

Icon	Name	Description
	<b>Calibrate from spectrum</b>	Opens the Mass Calibration Option dialog and uses the active spectrum to calibrate the mass spectrometer.
	<b>Manual Tune</b>	Opens the Manual Tune Editor.
	<b>Instrument Optimization</b>	Verifies the instrument performance, adjusts the mass calibration, or adjusts mass spectrometer settings.
	<b>View Queue</b>	Shows the sample queue.
	<b>Instrument Queue</b>	Shows a remote instrument.
	<b>Status for Remote Instrument</b>	Shows the status of a remote instrument.
	<b>Reserve Instrument for Tuning</b>	Reserves the instrument for tuning and calibrating.
	<b>Purge Modifier</b>	Click to purge or clear modifier from the modifier pump.

## Toolbar Icons

**Table C-4 Explore Quick Reference: Chromatograms and Spectrum**































Icon	Name	Description
	<b>Open Data File</b>	Opens files.
	<b>Show Next Sample</b>	Goes to the next sample.
	<b>Show Previous Sample</b>	Goes to the previous sample.
	<b>Go To Sample</b>	Opens the Select Sample dialog.
	<b>List Data</b>	Shows the data in tables.
	<b>Show TIC</b>	Generates a TIC from a spectrum.
	<b>Extract Using Dialog</b>	Extracts ions by selecting masses.
	<b>Show Base Peak Chromatogram</b>	Generates a BPC.
	<b>Show Spectrum</b>	Generates a spectrum from a TIC.
	<b>Copy Graph to new Window</b>	Copies the active graph to a new window.
	<b>Baseline Subtract</b>	Opens the Baseline Subtract dialog.
	<b>Threshold</b>	Adjusts the threshold.
	<b>Noise Filter</b>	Shows the Noise Filter Options dialog, which can be used define the minimum width of a peak. Signals below this minimum width are regarded as noise.
	<b>Show ADC</b>	Shows ADC data.
	<b>Show File Info</b>	Shows the experimental conditions used to collect the data.
	<b>Add arrows</b>	Adds arrows to the X-axis of the active graph.





Table C-4 Explore Quick Reference: Chromatograms and Spectrum (continued)

Icon	Name	Description
	<b>Remove all arrows</b>	Removes arrows from the X-axis of the active graph.
	<b>Offset Graph</b>	Compensates for slight differences in the time during which the ADC data and the mass spectrometer data were recorded. This is useful when overlaying graphs for comparison.
	<b>Force Peak Labels</b>	Labels all of the peaks.
	<b>Expand Selection By</b>	Sets the expansion factor for a portion of a graph to be viewed in greater detail.
	<b>Clear ranges</b>	Returns the expanded selection to normal view.
	<b>Set Selection</b>	Defines start and stop points for a selection. This feature provides more accurate selection than is possible by selecting the region using the cursor.
	<b>Normalize To Max</b>	Scales a graph to maximum size, so that the most intense peak is scaled to full scale, whether or not it is visible.
	<b>Show History</b>	Shows a summary of data processing operations performed on a particular file, such as smoothing, subtraction, calibration, and noise filtering.
	<b>Open Compound Database</b>	Opens the compound database.
	<b>Set Threshold</b>	Adjusts the threshold.
	<b>Show Contour Plot</b>	Shows selected data as either a spectrum graph or an XIC. Additionally, for data acquired by a DAD, a contour plot can show selected data as either a DAD spectrum or an XWC.
	<b>Show DAD TWC</b>	Generates a TWC of the DAD spectrum.
	<b>Show DAD Spectrum</b>	Generates a DAD spectrum.
	<b>Extract Wavelength</b>	Extracts up to three wavelength ranges from a DAD spectrum to view the XWC.

## Toolbar Icons

---

**Table C-5 Explore Toolbar Quick Reference: Overlaying Graphs**

Icon	Name	Description
	<b>Home Graph</b>	Return the graph to the original scale.
	<b>Overlay</b>	Overlays graphs.
	<b>Cycle Overlays</b>	Cycles between overlaid graphs.
	<b>Sum Overlays</b>	Adds the graphs together.

**Table C-6 Explore Toolbar Quick Reference: Fragment Interpretation Tool**

Icon	Name	Description
	<b>Show Fragment Interpretation Tool</b>	Opens the Fragment Interpretation tool, which calculates the single, non-cyclic bond cleavage fragments from a mol file.

**Table C-7 Navigation Icons on the Explore Toolbar**































Icon	Name	Function
	<b>Open File</b>	Opens files.
	<b>Show Next Sample</b>	Navigates to the next sample.
	<b>Show Previous Sample</b>	Navigates to the previous sample.
	<b>GoTo Sample</b>	Opens the Select Sample dialog.
	<b>List Data</b>	Shows the data in tables.
	<b>Show TIC</b>	Generates a TIC from a spectrum.
	<b>Extract Using Dialog</b>	Click to extract ions by selecting masses.

Table C-7 Navigation Icons on the Explore Toolbar (continued)



Icon	Name	Function
	<b>Show Base Peak Chromatogram</b>	Generates a BPC.
	<b>Show Spectrum</b>	Generates a spectrum from a TIC.
	<b>Copy Graph to new Window</b>	Copies the active graph to a new window.
	<b>Baseline Subtract</b>	Opens the Baseline Subtract dialog.
	<b>Threshold</b>	Adjusts the threshold.
	<b>Noise Filter</b>	Opens the Noise Filter Options dialog that defines the minimum width of a peak. Signals below this minimum width are regarded as noise.
	<b>Show ADC</b>	Shows ADC data.
	<b>Show File Info</b>	Shows the experimental conditions used to collect the data.
	<b>Add arrows</b>	Adds arrows to the X-axis of the active graph.
	<b>Remove all arrows</b>	Removes arrows from the X-axis of the active graph.
	<b>Offset Graph</b>	Compensates for slight differences in the time during which the ADC data and the mass spectrometer data were recorded. This is useful when overlaying graphs for comparison.
	<b>Force Peak Labels</b>	Labels all the peaks.
	<b>Expand Selection By</b>	Sets the expansion factor for a portion of a graph to view in greater detail.
	<b>Clear ranges</b>	Returns the expanded selection to normal view.

## Toolbar Icons

**Table C-7 Navigation Icons on the Explore Toolbar (continued)**





Icon	Name	Function
	<b>Set Selection</b>	Sets start and stop points for a selection. This provides more accurate selection than is possible by highlighting the region using the cursor.
	<b>Normalize to Max</b>	Scales a graph to maximum, so that the most intense peak is scaled is to full scale, whether or not it is visible.
	<b>Show History</b>	Shows a summary of data processing operations performed on a particular file, such as smoothing, subtraction, calibration, and noise filtering.
	<b>Open Compound Database</b>	Opens the compound database.
	<b>Set Threshold</b>	Adjusts the threshold.
	<b>Show Contour Plot</b>	Shows selected data as either a spectrum graph or an XIC. Additionally, for data acquired by a DAD, a contour plot can display selected data as either a DAD spectrum or an XWC.
	<b>Show DAD TWC</b>	Generates a TWC of the DAD.
	<b>Show DAD Spectrum</b>	Generates a DAD spectrum.
	<b>Extract Wavelength</b>	Extracts up to three wavelength ranges from a DAD spectrum to view the XWC.

**Table C-8 Integration Tab and Quantitation Wizard Icons**







Icon	Name	Description
	<b>Set parameters from Background Region</b>	Uses the selected peak.
	<b>Select Peak</b>	Uses the selected background.



**Table C-8 Integration Tab and Quantitation Wizard Icons (continued)**

Icon	Name	Description
	<b>Manual Integration Mode</b>	Manually integrates peaks.
	<b>Show or Hide Parameters</b>	Shows or hides the peak-finding parameters.
	<b>Show Active Graph</b>	Shows the analyte chromatogram only.
	<b>Show Both Analyte and IS</b>	Shows the analyte and its associated chromatogram. Available only when an associated internal standard exists.
	<b>Use Default View for Graph</b>	Returns to the preset, view all data, view if, for example, the user has zoomed in on a chromatogram.

**Table C-9 Results Table Icons**

Icon	Name	Description
	<b>Sort Ascending by Selection</b>	Sorts the selected column in ascending order.
	<b>Sort Descending by Selection</b>	Sorts the selected column in descending order.
	<b>Lock Or Unlock Column</b>	Locks or unlocks the selected column. A locked column cannot be moved.
	<b>Metric Plot By Selection</b>	Creates a metric plot from the selected column.
	<b>Show all Samples</b>	Shows all of the samples in the Results Table.
	<b>Delete Formula Column</b>	Deletes formula columns.

## Toolbar Icons

---

**Table C-9 Results Table Icons (continued)**

Icon	Name	Description
	<b>Report Generator</b>	Opens the Reporter software.

**Table C-10 Icon Quick Reference: Quantitate Mode**

















Icon	Name	Description
	<b>Add/Remove Samples</b>	Adds or removes samples from the Results Table.
	<b>Export as Text</b>	Saves the Results Table as a text file.
	<b>Modify Method</b>	Opens a wiff file.
	<b>Peak Review - Pane</b>	Opens peaks in a pane.
	<b>Peak Review - Window</b>	Opens peaks in a window.
	<b>Calibration - Pane</b>	Opens the calibration curve in a pane.
	<b>Calibration - Window</b>	Opens the calibration curve in a window.
	<b>Show First Peak</b>	Shows the first peak in the pane or window.
	<b>Show Last Peak</b>	Shows the last peak in the pane or window.
	<b>Show Audit Trail</b>	Shows the audit trail for the Results Table.
	<b>Clear Audit Trail</b>	Clears the audit trail for the Results Table. This functionality is not available.
	<b>Statistics</b>	Opens the Statistics window.
	<b>Report Generator</b>	Opens the Reporter software.

Table C-11 Acquire Mode Icons

Icon	Name	Function
	<b>Start Sample</b>	Click to start the sample in the queue.
	<b>Stop Sample</b>	Click to stop the sample in the queue.
	<b>Equilibrate</b>	Click to select a method to use to equilibrate the mass spectrometer, which includes the ion source, LC column if used, and any peripheral devices. This method should be the same as the one used with the first sample in the queue.

# Right-Click Menus

# D

## Batch Editor

Right-click the Batch Editor table to access the options.

Figure D-1 Batch Right-Click Menu

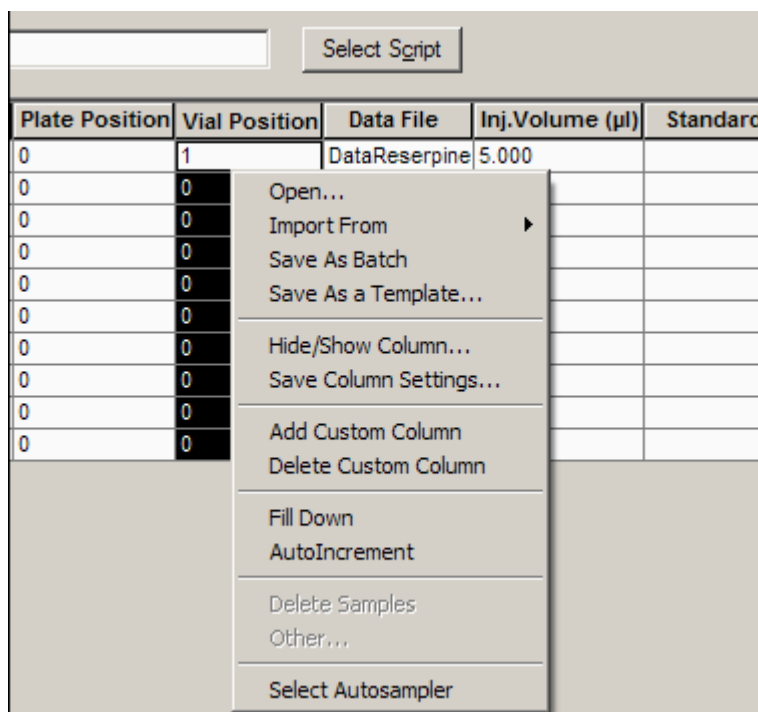

Menu	Function
Open	Opens a batch file.
Import From	Imports a batch from a file.
Save As Batch	Saves the batch with a different name.
Save As a Template	Saves the batch as a template.
Hide/Show Column	Hides or shows a column.

Menu	Function
<b>Save Column Settings</b>	Saves the batch column settings.
<b>Add Custom Column</b>	Adds a custom column.
<b>Delete Custom Column</b>	Deletes a custom column.
<b>Fill Down</b>	Copies the same data into the selected cells.
<b>AutoIncrement</b>	Automatically increments data in the selected cells.
<b>Delete Samples</b>	Deletes the selected row.
<b>Select Autosampler</b>	Selects an autosampler.

## Queue

Right-click the Queue table to access the options.

**Figure D-2 Queue Manager Right-Click Menu**

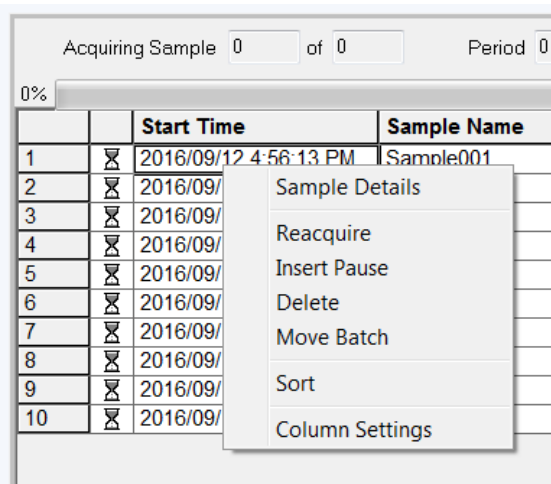

Menu	Function
<b>Sample Details</b>	Opens the Sample Details dialog.
<b>Reacquire</b>	Acquires a sample again.
<b>Insert Pause</b>	Inserts a pause, in seconds, between two samples.

## Right-Click Menus

---

Menu	Function
Delete	Deletes either the batch or the selected samples.
Move Batch	Moves the batch within the queue.
Sort	Sorts on the preselected column.
Column Settings	Changes the column settings.

## Show File Information Pane Right-click Menu

Table D-1 Show File Information Pane Right-click Menu

Menu	Function
Copy	Copies the selected data.
Paste	Pastes data.
Select All	Selects all of the data in the pane.
Save To File	Saves data as an rtf file.
Font	Changes the font.
Save Acquisition Method	Saves the acquisition method as a dam file.
Save Acquisition Method to CompoundDB	Opens the Specify Compound Information dialog. Select the IDs and molecular weights to be saved in the compound database.
Delete Pane	Deletes the selected pane.

## Chromatogram Panes

Table D-2 Right-click Menu for Chromatogram Panes

Menu	Function
List Data	Lists the data points and integrates the peaks found in chromatograms.
Show Spectrum	Generates a new pane containing the spectrum.
Show Contour Plot	Shows a color-coded plot of a dataset, where the color represents the intensity of the data at that point. Only certain MS modes are supported.
Extract Ions	Extracts a specific ion or set of ions from a selected pane and then generates a new pane containing a chromatogram for the specific ions.

Table D-2 Right-click Menu for Chromatogram Panes (continued)

Menu	Function
<b>Show Base Peak Chromatogram</b>	Generates a new pane containing a base peak chromatogram.
<b>Show ADC Data</b>	Generates a new pane containing the ADC data trace, if acquired.
<b>Show UV Detector Data</b>	Generates a new pane containing the UV data trace, if acquired.
<b>Spectral Arithmetic Wizard</b>	Opens the Spectral Arithmetic Wizard.
<b>Save to Text File</b>	Generates a text file containing the data in a pane, which can be opened in Microsoft Excel or other programs.
<b>Save Explore History</b>	Saves information about changes to processing parameters, also called processing options, that were made when a wiff file was processed in Explore mode. The processing history is stored in a file with an eph (explore processing history) extension.
<b>Add Caption</b>	Adds a caption at the cursor location in the pane.
<b>Add User Text</b>	Adds a text box at cursor location in the pane.
<b>Set Subtract Range</b>	Sets the subtract range in the pane.
<b>Clear Subtract Range</b>	Clears the subtract range in the pane.
<b>Subtract Range Locked</b>	Locks or unlocks the subtract ranges. If the subtract ranges are not locked, then each subtract range can be moved independently. The subtract ranges are preset to locked.
<b>Delete Pane</b>	Deletes the selected pane.

## Spectra Panes

Table D-3 Right-click Menu for Spectra Panes

Menu	Function
<b>List Data</b>	Lists the data points and integrates chromatograms.
<b>Show TIC</b>	Generates a new pane containing the TIC.
<b>Extract Ions (Use Range)</b>	Extracts a specific ion or set of ions from a selected pane and then generates a new pane containing a chromatogram for the specific ions.

## Right-Click Menus

---

**Table D-3 Right-click Menu for Spectra Panes (continued)**

<b>Menu</b>	<b>Function</b>
<b>Extract Ions (Use Maximum)</b>	Extracts ions using the most intense peak in a selected area.
<b>Save to Text File</b>	Generates a text file of the pane, which can be opened in Microsoft Excel or other programs.
<b>Save Explore History</b>	Saves information about changes to processing parameters, also called Processing Options, that were made when a wiff file was processed in Explore mode. The processing history is stored in a file with an eph (explore processing history) extension.
<b>Add Caption</b>	Adds a caption at the cursor location in the pane.
<b>Add User Text</b>	Adds a text box at the cursor location in the pane.
<b>Show Last Scan</b>	Shows the scan prior to the selection.
<b>Select Peaks For Label</b>	In this dialog, select the parameters to reduce peak labeling.
<b>Re-Calibrate TOF</b>	Opens the TOF Calibration dialog.
<b>Abscissa (Time)</b>	Changes the view to display TOF values on the x-axis.
<b>Delete Pane</b>	Deletes the selected pane.
<b>Add a Record</b>	Adds records and compound-related data, including spectra, to the library. An active spectrum is required to perform this task.
<b>Search Library</b>	Searches the library without constraints or with previously saved constraints.
<b>Set Search Constraints</b>	Searches the library using the criteria typed in Search Constraints dialog.

## Results Table

Right-click the Results Table to access the options shown in the following table.

**Table D-4 Results Table Right-click Menu**

<b>Menu</b>	<b>Function</b>
<b>Full</b>	Shows all the columns.



Table D-4 Results Table Right-click Menu (continued)

Menu	Function
<b>Summary</b>	Shows specific columns.
<b>Analyte</b>	Shows a specific analyte.
<b>Analyte Group</b>	Creates an analyte group.
<b>Sample Type</b>	Shows samples of a specific type or all samples.
<b>Add Formula Column</b>	Adds a formula column. It is recommended that the user validate the results if a formula column is used.
<b>Table Settings</b>	Edits or selects a table setting.
<b>Query</b>	Creates or selects a query.
<b>Sort</b>	Creates a sort or sorts by index.
<b>Metric Plot</b>	Creates a metric plot.
<b>Delete Pane</b>	Deletes the active pane.
<b>Fill Down</b>	Copies the same data into the selected cells.
<b>Add Custom Column</b>	Adds a custom column.
<b>Delete Custom Column</b>	Deletes the selected custom column.

## Peak Review

Right-click the **Peak Review** window or pane to access the options shown in [Table D-5](#).

Table D-5 Peak Review Right-click Menu

Menu	Function
<b>Options</b>	Opens the Peak Review Options dialog.
<b>Sample Annotation</b>	Opens the Sample Annotation dialog.
<b>Save Active to Text File</b>	Saves the selected peak as a text file.

## Right-Click Menus

---

Table D-5 Peak Review Right-click Menu (continued)

Menu	Function
Show First Page	Goes to the first sample.
Show Last Page	Goes to the last sample.
Slide Show Peak Review	Opens the slide show.
Update Method	Updates the algorithm for all peaks.
Revert to Method	Selects a redefined peak based on the current quantitation method.
Delete Pane	Deletes the active pane.

## Calibration Curve

Right-click the Calibration window or pane table to access the options shown in the following table.

Table D-6 Calibration Curve Right-click Menu

Menu	Function
Exclude (Include)	Right-click a point and then click <b>Exclude</b> to exclude the point from the curve. Right-click a point and then click <b>Include</b> to include the point.
Exclude All Analytes (Include All Analytes)	Right-click a point and then click <b>Exclude All Analytes</b> to exclude all of the analytes from the curve. Right-click a point and then click <b>Include All Analytes</b> to include the points.
Show Peak	Reviews an individual peak.
Overlay	Overlays two graphs.
Active Plot	Determines which plot is active.
Legend	Shows the graph legend.
Log Scale X Axis*	Uses a log scale for the X-axis.
Log Scale Y Axis*	Uses a log scale for the Y-axis.

Table D-6 Calibration Curve Right-click Menu (continued)









Menu	Function
Delete Pane	Deletes the active pane.
Home Graph	Scales the graph to its original size









\* A log scale arranges the data points in a more manageable view so that the effect of all points can be monitored simultaneously. For this view, select **Log Scale Y Axis** versus **Log Scale X** and not just the log of one axis.

# Glossary of Symbols

# E









**Note:** Not all of the symbols in the following table are applicable to every instrument.





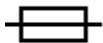



Symbol	Description
	Australian Regulatory Compliance Mark. Indicates that the product complies with Australian Communications Media Authority (ACMA) EMC Requirements.
	Alternating current
A	Amperes (current)
	Asphyxiation Hazard
	Authorized representative in the European community
	Biohazard
	CE Marking of Conformity
	cCSAus mark. Indicates electrical safety certification for Canada and USA.
	Catalog number

Symbol	Description
	<p>Caution. Consult the instructions for information about a possible hazard.</p> <p><b>Note:</b> In SCIEX documentation, this symbol identifies a personal injury hazard.</p>
	<p>China RoHS Caution Label. The electronic information product contains certain toxic or hazardous substances. The center number is the Environmentally Friendly Use Period (EFUP) date, and indicates the number of calendar years the product can be in operation. Upon the expiration of the EFUP, the product must be immediately recycled. The circling arrows indicate the product is recyclable. The date code on the label or product indicates the date of manufacture.</p>
	<p>China RoHS logo. The device does not contain toxic and hazardous substances or elements above the maximum concentration values and it is an environmentally-friendly product that can be recycled and reused.</p>
	<p>Consult instructions for use.</p>
	<p>Crushing Hazard</p>
	<p>cTUVus mark for TUV Rheinland of North America</p>
	<p>Data Matrix symbol that can be scanned by a barcode reader to obtain a unique device identifier (UDI)</p>
	<p>Environmental Hazard</p>
	<p>Ethernet connection</p>







## Glossary of Symbols

---

Symbol	Description
	Explosion Hazard
	Eye Injury Hazard
	Fire Hazard
	Flammable Chemical Hazard
	Fragile
	Fuse
Hz	Hertz
	International safety symbol "Caution, risk of electric shock" (ISO 3864), also known as High Voltage symbol If the main cover must be removed, then contact a SCIEX representative to prevent electric shock.
	Hot Surface Hazard
	In Vitro Diagnostic Device
	Ionizing Radiation Hazard





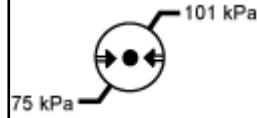
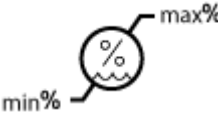
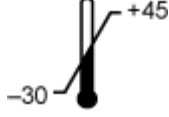
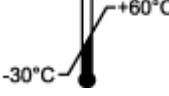

Symbol	Description
	Keep dry. Do not expose to rain. Relative humidity must not exceed 99%.
	Keep upright.
	Lacerate/Sever Hazard
	Laser Radiation Hazard
	Lifting Hazard
	Magnetic Hazard
	Manufacturer
	Moving Parts Hazard
	Pacemaker Hazard. No access to people with pacemakers.
	Pinching Hazard

## Glossary of Symbols

Symbol	Description
	Pressurized Gas Hazard
	Protective Earth (ground)
	Puncture Hazard
	Reactive Chemical Hazard
	Serial number
	Toxic Chemical Hazard
	Transport and store the system within 66 kPa to 103 kPa.
	Transport and store the system within 75 kPa to 101 kPa.
	Transport and store the system within the specified minimum ( <b>min</b> ) and maximum ( <b>max</b> ) levels of relative humidity, noncondensing.
	Transport and store the system within $-30\text{ }^{\circ}\text{C}$ to $+45\text{ }^{\circ}\text{C}$ .
	Transport and store the system within $-30\text{ }^{\circ}\text{C}$ to $+60\text{ }^{\circ}\text{C}$ .



## Glossary of Symbols

Symbol	Description
	USB 2.0 connection
	USB 3.0 connection
	Ultraviolet Radiation Hazard
	United Kingdom Conformity Assessment Mark
VA	Volt Ampere (power)
V	Volts (voltage)
	WEEE. Do not dispose of equipment as unsorted municipal waste. Environmental Hazard
W	Watts
	<i>yyyy-mm-dd</i> Date of manufacture

# Glossary of Warnings

# F

**Note:** If any of the labels used to identify a component become detached, contact a Field Service Employee (FSE).

Label	Translation (if applicable)
FOR RESEARCH USE ONLY. NOT FOR USE IN DIAGNOSTIC PROCEDURES.	FOR RESEARCH USE ONLY. NOT FOR USE IN DIAGNOSTIC PROCEDURES.
IMPACT INDICATOR  SENSITIVE PRODUCT WARNING	IMPACT INDICATOR  SENSITIVE PRODUCT WARNING  <b>Note:</b> If the indicator is tripped, then this container has been dropped or otherwise mishandled. Make a note on the Bill of Lading and then check for damage. Any claims for shock damage require a notation.
IMPORTANT!  RECORD ANY VISIBLE CRATE DAMAGE INCLUDING TRIPPED "IMPACT INDICATOR" OR "TILT INDICATOR" ON THE WAYBILL BEFORE ACCEPTING SHIPMENT AND NOTIFY YOUR LOCAL AB SCIEX CUSTOMER SUPPORT ENGINEER IMMEDIATELY.  DO NOT UNCRATE. CONTACT YOUR LOCAL CUSTOMER SUPPORT ENGINEER FOR UNCRATING AND INSTALLATION.	IMPORTANT!  RECORD ANY VISIBLE CRATE DAMAGE INCLUDING TRIPPED "IMPACT INDICATOR" OR "TILT INDICATOR" ON THE WAYBILL BEFORE ACCEPTING SHIPMENT AND NOTIFY YOUR LOCAL AB SCIEX CUSTOMER SUPPORT ENGINEER IMMEDIATELY.  DO NOT UNCRATE. CONTACT YOUR LOCAL CUSTOMER SUPPORT ENGINEER FOR UNCRATING AND INSTALLATION.
TIP & TELL	Tilt Indicator  <b>Note:</b> Indicates whether the container was tipped or mishandled. Write on the Bill of Lading and inspect for damage. Any claims for tipping require a notation.

Label	Translation (if applicable)
<p>TiltWatch PLUS</p> <p>ShockWatch</p>	<p>Tilt Indicator</p> <hr/> <p><b>Note:</b> Indicates whether the container was tipped or mishandled. Write on the Bill of Lading and inspect for damage. Any claims for tipping require a notation.</p>
<p>WARNING: DO NOT OPERATE WITHOUT FIRST ENSURING BOTTLE CAP IS SECURED.</p>	<p>WARNING: DO NOT OPERATE WITHOUT FIRST ENSURING BOTTLE CAP IS SECURED.</p> <hr/> <p><b>Note:</b> This warning is attached to the source exhaust waste bottle.</p>
<p>WARNING: NO USER SERVICEABLE PARTS INSIDE. REFER SERVICING TO QUALIFIED PERSONNEL.</p>	<p>WARNING: NO USER SERVICEABLE PARTS INSIDE. REFER SERVICING TO QUALIFIED PERSONNEL.</p> <hr/> <p><b>Note:</b> Consult instructions for use.</p>

# Contact Us

---

## Customer Training

- In North America: [NA.CustomerTraining@sciex.com](mailto:NA.CustomerTraining@sciex.com)
- In Europe: [Europe.CustomerTraining@sciex.com](mailto:Europe.CustomerTraining@sciex.com)
- Outside the EU and North America, visit [sciex.com/education](http://sciex.com/education) for contact information.

## Online Learning Center

- [SCIEX Now Learning Hub](#)

## SCIEX Support

SCIEX and its representatives maintain a staff of fully-trained service and technical specialists located throughout the world. They can answer questions about the system or any technical issues that might arise. For more information, visit the SCIEX website at [sciex.com](http://sciex.com) or contact us in one of the following ways:

- [sciex.com/contact-us](http://sciex.com/contact-us)
- [sciex.com/request-support](http://sciex.com/request-support)

## CyberSecurity

For the latest guidance on cybersecurity for SCIEX products, visit [sciex.com/productsecurity](http://sciex.com/productsecurity).

## Documentation

This version of the document supersedes all previous versions of this document.

To view this document electronically, Adobe Acrobat Reader is required. To download the latest version, go to <https://get.adobe.com/reader>.

To find software product documentation, refer to the release notes or software installation guide that comes with the software.

To find hardware product documentation, refer to the *Customer Reference* DVD that comes with the system or component.

The latest versions of the documentation are available on the SCIEX website, at [sciex.com/customer-documents](https://sciex.com/customer-documents).

---

**Note:** To request a free, printed version of this document, contact [sciex.com/contact-us](https://sciex.com/contact-us).

---