

ZenoTOF 7600+ System

System User Guide



This document is provided to customers who have purchased SCIEX equipment to use in the operation of such SCIEX equipment. This document is copyright protected and any reproduction of this document or any part of this document is strictly prohibited, except as SCIEX may authorize in writing.

Software that may be described in this document is furnished under a license agreement. It is against the law to copy, modify, or distribute the software on any medium, except as specifically allowed in the license agreement. Furthermore, the license agreement may prohibit the software from being disassembled, reverse engineered, or decompiled for any purpose. Warranties are as stated therein.

Portions of this document may make reference to other manufacturers and/or their products, which may contain parts whose names are registered as trademarks and/or function as trademarks of their respective owners. Any such use is intended only to designate such products as those manufacturers' products and does not imply any right and/or license to use or permit others to use such manufacturers' and/or their product names as trademarks.

SCIEX warranties are limited to those express warranties provided at the time of sale or license of its products and are the sole and exclusive representations, warranties, and obligations of SCIEX. SCIEX makes no other warranty of any kind whatsoever, expressed or implied, including without limitation, warranties of merchantability or fitness for a particular purpose, whether arising from a statute or otherwise in law or from a course of dealing or usage of trade, all of which are expressly disclaimed, and assumes no responsibility or contingent liability, including indirect or consequential damages, for any use by the purchaser or for any adverse circumstances arising therefrom.

(GEN-IDV-09-10816-E)

For Research Use Only. Not for use in Diagnostic Procedures.

Trademarks and/or registered trademarks mentioned herein, including associated logos, are the property of AB Sciex Pte. Ltd., or their respective owners, in the United States and/or certain other countries (see sciex.com/trademarks).

AB Sciex™ is being used under license.

© 2024 DH Tech. Dev. Pte. Ltd.



AB Sciex Pte. Ltd.
Blk33, #04-06 Marsiling Industrial Estate Road 3
Woodlands Central Industrial Estate, Singapore 739256

Contents

1 Operational Precautions and Limitations	6
General Safety Information.....	6
Documentation Symbols and Conventions.....	6
Regulatory Compliance.....	7
Australia and New Zealand.....	7
Canada.....	7
Europe.....	7
United States.....	8
International.....	8
Electrical Precautions.....	8
Mains Supply.....	9
Protective Earth Conductor.....	9
Chemical Precautions.....	10
System Safe Fluids.....	11
Ventilation Precautions.....	12
Physical Precautions.....	13
Environmental Precautions.....	13
Electromagnetic Environment.....	14
Decommissioning and Disposal.....	15
Qualified Personnel.....	15
Laboratory Conditions.....	16
Safe Environmental Conditions.....	16
Performance Specifications.....	16
Equipment Use and Modification.....	16
2 Principles of Operation	18
System Overview.....	18
Hardware Overview.....	19
Theory of Operation.....	22
3 Operating Instructions — Hardware	23
Start Up the System.....	23
Shut Down and Vent the System.....	26
Diverter Valve.....	28
Plumb the Diverter Valve in Injector Mode.....	28
Plumb the Diverter Valve in Diverter Mode.....	29
Calibrant Delivery System.....	31
Replace the CDS Bottle.....	31

Contents

Start the CDS	31
Stop the CDS	32
Flush the CDS	32
4 Operating Instructions — User Workflows	36
5 Service and Maintenance Information	38
Recommended Maintenance Schedule	38
Clean the Surfaces	40
Clean the Front End	41
Symptoms of Contamination	41
Required Materials	41
Cleaning Best Practices	42
Prepare the Mass Spectrometer	44
Clean the Curtain Plate	45
Clean the Front of the Orifice Plate	46
Put the Mass Spectrometer Back in Service	46
Empty the Source Exhaust Drain Bottle	47
Replace the Check Valve and Flow Module	49
Replace the CDS Bottle Intake Filters	50
Inspect the Roughing Pump Oil Level (Oil-Sealed Roughing Pump)	51
Storage and Handling	52
Move the Mass Spectrometer	53
Open the Dress Panel	59
6 Mass Spectrometer Troubleshooting	61
A Recommended Calibration Ions	67
APCI Calibration Ions	67
ESI Calibration Ions	69
B Exact Masses and Chemical Formulas	71
C Glossary of Symbols	73
D Glossary of Warnings	79
Contact Us	81
Customer Training	81
Online Learning Center	81
SCIEX Support	81

Cybersecurity	81
Documentation	81

Operational Precautions and Limitations

1

Note: Before operating the system, carefully read all of the sections of this guide.

This section contains information about general safety and regulatory compliance. This section gives descriptions of possible hazards and the related warnings for the system, and the precautions that should be obeyed to minimize the hazards.

In addition to this section, for information about the symbols and conventions that are used in the laboratory environment, on the system, and in this documentation, refer to the section: [Glossary of Symbols](#). For site requirements, including mains supply, source exhaust, ventilation, compressed air, nitrogen, and roughing pump requirements, refer to the document: *Site Planning Guide*.

General Safety Information

To prevent personal injury or system damage, read, understand, and obey all of the safety precautions and warnings in this document, the manufacturer chemical safety data sheets (SDSs), and product label information. Labels are shown with internationally recognized symbols. Failure to heed these warnings could result in serious injury.

This safety information is intended to supplement federal, state, provincial, and local environmental health and safety (EHS) regulations. The information provided includes system-related safety information applicable to the operation of the system. It does not include every safety procedure that should be practiced. Ultimately, the user and the organization are responsible for compliance with federal, state, provincial, and local EHS regulations and for maintaining a safe laboratory environment.

Refer to the correct laboratory reference material and standard operating procedures.

Documentation Symbols and Conventions

The following symbols and conventions are used throughout the guide.



DANGER! Danger identifies an action that can cause severe injury or death.



WARNING! Warning identifies an action that can cause personal injury if precautions are not obeyed.

CAUTION: Caution identifies an operation that can cause damage to the system or corruption or loss of data if precautions are not obeyed.

Note: Notes supply important information in a procedure or description.

Tip! Tips supply information that helps to apply the techniques in a procedure or gives a shortcut, but that is not essential to the completion of a procedure.

Regulatory Compliance

This system complies with the regulations and standards listed in this section. For dated references, refer to the declaration of conformity included with the system and the individual system components. Applicable labels have been affixed to the system.

Australia and New Zealand

- **Electromagnetic Compatibility (EMC):** Radio Communications Act 1992 as implemented in these standards:
 - Electromagnetic Interference—AS/NZS CISPR 11/ EN 55011/ CISPR 11 (Class A). Refer to the section: [Electromagnetic Interference](#).
- **Safety:** AS/NZ 61010-1 and IEC 61010-2-061

Canada

- **Electromagnetic Interference (EMI):** CAN/CSA CISPR11. This ISM device complies with Canadian ICES-001. Refer to the section: [Electromagnetic Interference](#).
- **Safety:**
 - CAN/CSA C22.2 No. 61010-1
 - CAN/CSA C22.2 No 61010-2-061

Europe

- **Electromagnetic Compatibility (EMC):** Electromagnetic Compatibility Directive 2014/30/EU as implemented in these standards:
 - EN 61326-1
 - EN 55011 (Class A)Refer to the section: [Electromagnetic Compatibility](#).
- **Safety:** Low Voltage Directives 2014/35/EU as implemented in these standards:
 - EN 61010-1

Operational Precautions and Limitations

- EN 61010-2-061
- **Waste Electrical and Electronic Equipment (WEEE):** Waste Electrical and Electronic Equipment Directive 2012/19/EU, as implemented in EN 40519. Refer to the section: [Waste Electrical and Electronic Equipment](#).
- **Packaging and Packaging Waste (PPW):** Packaging and Packaging Waste Directive 94/62/EC
- **RoHS Restriction of Hazardous Substances:** RoHS Directive 2011/65/EU and 2015/863/EU

United States

- **Radio Emissions Interference Regulations:**
 - 47 CFR 15, as implemented in FCC Part 15 (Class A)
- **Safety:** Occupational Safety and Health Regulations, 29 CFR 1910, as implemented in these standards:
 - UL 61010-1
 - IEC 61010-2-061

International

- **Electromagnetic Compatibility (EMC):**
 - IEC 61326-1
 - IEC CISPR 11 (Class A)
 - IEC 61000-3-2
 - IEC 61000-3-3

Refer to the section: [Electromagnetic Compatibility](#).

- **Safety:**
 - IEC 61010-1
 - IEC 61010-2-061

Electrical Precautions



WARNING! Electrical Shock Hazard. Do not remove the covers. If the covers are removed, then injury or incorrect system operation can occur. Removal of the covers is not required for routine maintenance, inspection, or adjustment. Contact a SCIEX field service employee (FSE) for repairs that require removal of the covers.



WARNING! Fire Hazard or Electrical Shock Hazard. Contact SCIEX if a fuse must be installed or replaced. Always turn off the power and then disconnect the power cable before working with fuses. Replace a fuse only with a fuse of the correct type and rating.

- Obey the required electrical safe work practices.
- Use cable management practices to control electrical cables and decrease the risk of a tripping hazard.

For information about system electrical specifications, refer to the document: *Site Planning Guide*.

Mains Supply

Connect the system to a compatible mains supply as instructed in this guide.



WARNING! Electrical Shock Hazard. Use only qualified personnel for the installation of all of the electrical supplies and fixtures, and make sure that all of the installations adhere to local regulations and safety standards.



WARNING! Electrical Shock Hazard. Make sure that the system can be disconnected from the mains supply outlet in an emergency. Do not block the mains supply outlet.



WARNING! Electrical Shock Hazard. Use only the mains supply cables that are supplied with the system. Do not use mains supply cables that are not correctly rated for the operation of this system.

An external line transformer is not needed for the mass spectrometer or roughing pump.

Protective Earth Conductor

The mains supply must include a correctly installed protective earth conductor. The protective earth conductor must be installed or examined by a qualified electrician before the system is connected.



WARNING! Electrical Shock Hazard. Do not intentionally interrupt the protective earth conductor. Any interruption of the protective earth conductor causes an electrical shock hazard.



WARNING! Electrical Shock Hazard. Make sure that a protective earth conductor (grounding cable) is connected between the sample loop and an applicable grounding point at the ion source. This supplementary grounding reinforces the safety configuration specified by SCIEX.

Chemical Precautions



WARNING! Ionizing Radiation Hazard, Biohazard, or Toxic Chemical Hazard. Before cleaning or maintenance, identify whether decontamination is required. If radioactive materials, biological agents, or toxic chemicals have been used with the system, then the customer must decontaminate the system before cleaning or maintenance.



WARNING! Environmental Hazard. Do not discard system components in municipal waste. To discard components correctly, obey local regulations.



WARNING! Biohazard or Toxic Chemical Hazard. To prevent leaks, connect the drain tubing to the mass spectrometer and the source exhaust drain bottle correctly.

- Before servicing and regular maintenance, identify the chemicals that have been used in the system. For the health and safety precautions that must be obeyed for a chemical, refer to the safety data sheet (SDS). For storage information, refer to the certificate of analysis. To find a SCIEX SDS or certificate of analysis, go to [sciex.com/tech-regulatory](https://www.sciex.com/tech-regulatory).
- Always wear assigned personal protective equipment, including powder-free gloves, protective eyewear, and a laboratory coat.

Note: Nitrile or neoprene gloves are recommended.

- Do work in a well-ventilated area or fume hood.
- When flammable materials such as isopropanol, methanol, and other flammable solvents are in use, do not go near ignition sources.
- Be careful with the use and disposal of any chemicals. If the correct procedures for chemical handling and disposal are not obeyed, then personal injury can occur.
- During cleaning, do not let chemicals touch the skin. Wash hands after use.
- Make sure that all exhaust hoses are connected correctly and that all connections are functioning as designed.
- Collect all spent liquids and discard them as hazardous waste.
- Obey all of the local regulations for the storage, handling, and disposal of biohazardous, toxic, and radioactive materials.
- Oil-sealed roughing pump: (Recommended) Use a secondary containment tray below the roughing pump.

Note: Secondary containment is not required for the dry roughing pump.

- (Recommended) Use secondary containment trays below the solvent bottles and the waste container to collect potential chemical spills.

System Safe Fluids

The following fluids can safely be used with the system. For information about safe cleaning solutions, refer to the section: [Required Materials](#).

CAUTION: Potential System Damage. Do not use any other fluid until confirmation is received from SCIEX that it does not cause a hazard. This is not an exhaustive list.

Note: Use only new, freshly prepared LC-MS-grade or better solvents for the LC mobile phases.

- **Organic Solvents**
 - LC-MS-grade acetonitrile, up to 100%
 - LC-MS-grade methanol, up to 100%
 - LC-MS-grade isopropanol, up to 100%
 - LC-MS-grade or higher water, up to 100%
 - Tetrahydrofuran, up to 100%
 - Toluene and other aromatic solvents, up to 100%
 - Hexanes, up to 100%
- **Buffers**
 - Ammonium acetate, less than 100 mM
 - Ammonium formate, less than 100 mM
 - Phosphate, less than 1%
- **Acids and Bases**
 - Formic acid, less than 1%
 - Acetic acid, less than 1%
 - Trifluoroacetic acid (TFA), less than 1%
 - Heptafluorobutyric acid (HFBA), less than 1%
 - Ammonia/ammonium hydroxide, less than 1%
 - Phosphoric acid, less than 1%
 - Trimethylamine, less than 1%
 - Triethylamine, less than 1%

Ventilation Precautions

The venting of fumes and disposal of waste must comply with all of the federal, state, provincial, and local health and safety regulations. It is the responsibility of the customer to make sure that the air quality is maintained in compliance with local health and safety regulations.

The source exhaust system and roughing pump must be vented to a dedicated laboratory fume hood or an external exhaust system.



WARNING! Fire Hazard. Make sure that the source exhaust system is connected and functioning, to prevent flammable vapor from accumulating in the ion source.



WARNING! Ionizing Radiation Hazard, Biohazard, or Toxic Chemical Hazard. Take care to vent exhaust gases to a dedicated laboratory fume hood or exhaust system and make sure that the ventilation tubing is secured with clamps. Make sure that the laboratory has correct air exchange for the work performed.



WARNING! Ionizing Radiation Hazard, Biohazard, or Toxic Chemical Hazard. Do not operate the mass spectrometer if the source exhaust drain and roughing pump exhaust hoses are not properly connected to the laboratory ventilation system. Examine the exhaust tubing regularly to make sure that there are no leaks. The use of mass spectrometers without proper system ventilation might constitute a health hazard and might result in serious injury.



WARNING! Ionizing Radiation Hazard, Biohazard, or Toxic Chemical Hazard. Do not use the ion source without knowledge of and training in the proper use, containment, and evacuation of toxic or injurious materials used with the ion source.



WARNING! Puncture Hazard, Ionizing Radiation Hazard, Biohazard, or Toxic Chemical Hazard. If the ion source window is cracked or broken, then do not use the ion source. Contact a SCIEX field service employee (FSE). Any toxic or injurious materials introduced in the equipment will be present in the source exhaust output. Exhaust from equipment should be vented from the room. Dispose of sharps following established laboratory safety procedures.

Physical Precautions



WARNING! Hot Surface Hazard. Let the Turbo V ion source cool for at least 30 minutes before starting any maintenance procedures. Some surfaces of the ion source and vacuum interface become hot during operation.



WARNING! Lifting Hazard. Use a mechanical lifting device to lift and move the mass spectrometer. If the mass spectrometer must be moved manually, then at least 11 people are required to move the system safely. Follow established safe lifting procedures. We recommend the use of a professional moving service. For the weights of system components, refer to the document: *Site Planning Guide*.

Environmental Precautions

Use qualified personnel for the installation of electrical mains, heating, ventilation, and plumbing supplies and fixtures. Make sure that all of the installations comply with local bylaws and biohazard regulations. For information about the required environmental conditions for the system, refer to the document: *Site Planning Guide*.

When the system is set up, make sure that there is sufficient access space around the equipment.



DANGER! Explosion Hazard. Do not operate the system in an environment that contains explosive gases. The system is not designed for operation in an explosive environment.



WARNING! Biohazard. For biohazardous material use, always obey local regulations for hazard assessment, control, and handling. Neither this system nor any part is intended to be used as a biological containment.



WARNING! Environmental Hazard. Obey established procedures for disposal of biohazardous, toxic, radioactive, and electronic waste. The customer is responsible for the disposal of hazardous substances, including chemicals, waste oils, and electrical components, in accordance with local laws and regulations.

CAUTION: Potential Mass Shift. Maintain a stable ambient temperature. If the temperature changes by more than 2 °C per hour, then the resolution and mass calibration might be affected.

Electromagnetic Environment

Electromagnetic Compatibility

Basic Electromagnetic Environment: Environment existing at locations characterized by being supplied directly at low voltage from the public mains network.

Performance Criteria A (Criteria A): Equipment shall operate as intended with no degradation of performance and no loss of function during or after the test.

Performance Criteria B (Criteria B): Equipment may experience loss of function (one or more) during the test but shall operate as intended after the test.

Performance Criteria C (Criteria C): LOSS OF FUNCTION is allowed, provided the function is self-recoverable or can be restored by the operation of the controls.

The equipment is intended for use in a basic electromagnetic environment.

The permissible performance loss under the electromagnetic immunity conditions is less than 20% change in total ion count (TIC).

Make sure that a compatible electromagnetic environment for the equipment can be maintained so that the device will operate as intended. If the power supply line is subject to high electrical noise, then install a surge protector.

Electromagnetic Interference

Group 1 Equipment: This equipment is classified as industrial, scientific, and medical (ISM) equipment that might use RF energy for internal operation.

Class A Equipment: Equipment which is suitable for use in all establishments other than domestic and those directly connected to a low voltage power supply network which supplies buildings used for domestic purposes. [Derived from CISPR 11:2009, 5.3] Class A equipment shall meet Class A limits.

CAUTION: Potential Radio Interference. This equipment is not intended for use in residential environments and may not supply adequate protection to radio reception in such environments.

This equipment has been tested and found to comply with the limits for a Class A digital device, pursuant to Part 15 of the FCC (Federal Communications Commission) Compliance Rules.

These limits are designed to provide reasonable protection against harmful interference when the equipment is operated in a commercial environment. This equipment generates, uses, and can radiate radio frequency energy and, if not installed and used in accordance with the operator's manual, can cause harmful interference to radio communications.

Operation of this equipment in a residential area is likely to cause harmful interference in which case you will be required to correct the interference, at your own expense. Changes or

modifications not expressly approved by the manufacturer could void your authority to operate the equipment.

Decommissioning and Disposal



WARNING! Environmental Hazard. Obey established procedures for disposal of biohazardous, toxic, radioactive, and electronic waste. The customer is responsible for the disposal of hazardous substances, including chemicals, waste oils, and electrical components, in accordance with local laws and regulations.

Before decommissioning, obey local regulations to decontaminate the entire system.

When the system is removed from service, obey national and local environmental regulations to divide and recycle different materials. Refer to the section: [Storage and Handling](#).

Note: SCIEX will not accept any system returns without a completed *Decontamination Form*. Contact an FSE to get a copy of the form.

Do not discard system components or subassemblies, including computer parts, as unsorted municipal waste.

Waste Electrical and Electronic Equipment

Obey local municipal waste ordinances for the correct disposal provisions to decrease the environmental impact of waste, electrical, and electronic equipment (WEEE). To discard this equipment safely, contact a local Customer Service office for complimentary equipment pick-up and recycling.

Qualified Personnel

Only qualified SCIEX personnel are permitted to install, examine, and supply servicing for the equipment. After the system has been installed, the field service employee (FSE) uses the document: *Customer Familiarization Checklist* to help the customer become familiar with system operation, cleaning, and basic maintenance. If a system under warranty is serviced by personnel who are not authorized by SCIEX, then SCIEX is not responsible to repair any damage caused by the servicing.

Only personnel qualified by the manufacturer shall maintain the equipment. A laboratory designate can be familiarized with the qualified maintenance person (QMP) procedures during the installation. A QMP is a person who is suitably aware of the electrical and chemical risks associated with servicing laboratory equipment.

Laboratory Conditions

Safe Environmental Conditions

The system is designed to operate safely in these conditions:

- Indoors
- Altitude: Up to 2,000 m (6,560 ft) above sea level
- Ambient temperature: 5 °C (41 °F) to 40 °C (104 °F)
- Relative humidity: 20% to 80%, noncondensing
- Mains supply voltage fluctuations: $\pm 10\%$ of the nominal voltage
- Transient overvoltages: Up to the levels of Overvoltage Category II
- Temporary overvoltages on the mains supply
- Pollution Degree 2

Performance Specifications

The system is designed to meet specifications under these conditions:

- An ambient temperature of 15 °C to 30 °C (59 °F to 86 °F)

Over time, the temperature must remain within a range of 2 °C (3.6 °F), with the rate of the change in temperature not exceeding 2 °C (3.6 °F) per hour. Ambient temperature fluctuations exceeding the limits might result in mass shifts in spectra.

- Relative humidity from 20% to 80%, noncondensing

Equipment Use and Modification



WARNING! Electrical Shock Hazard. Do not remove the covers. If the covers are removed, then injury or incorrect system operation can occur. Removal of the covers is not required for routine maintenance, inspection, or adjustment. Contact a SCIEX field service employee (FSE) for repairs that require removal of the covers.



WARNING! Personal Injury Hazard. Use SCIEX-recommended parts only. The use of parts that are not recommended by SCIEX or the use of parts for any purpose other than their intended purpose can put the user at risk of harm or have a negative effect on system performance.



WARNING! Lifting Hazard. Use a mechanical lifting device to lift and move the mass spectrometer. If the mass spectrometer must be moved manually, then at least 11 people are required to move the system safely. Follow established safe lifting procedures. We recommend the use of a professional moving service. For the weights of system components, refer to the document: *Site Planning Guide*.

CAUTION: Potential System Damage. Do not use laboratory cleaning solvents or waxes that give off gas near the mass spectrometer. The gas can cause high background noise.

Use the system indoors in a laboratory that complies with the environmental conditions recommended in the mass spectrometer document: *Site Planning Guide*.

If the system is used in conditions or in an environment that are not approved by the manufacturer, then the performance and protection that is supplied by the equipment might be decreased or lost.

Contact an FSE for information about servicing the system. Unauthorized modification or operation of the system might cause personal injury and equipment damage, and might void the warranty. If the system is operated outside the recommended environmental conditions or with unauthorized modifications, then the acquired data might be inaccurate.

The system is designed for the qualitative and quantitative analysis of chemical species.

This section includes information about the mass spectrometer. For an overview of the ion source, refer to the document: *Turbo V Ion Source Operator Guide*.

System Overview



WARNING! Lifting Hazard. Use a mechanical lifting device to lift and move the mass spectrometer. If the mass spectrometer must be moved manually, then at least 11 people are required to move the system safely. Follow established safe lifting procedures. We recommend the use of a professional moving service. For the weights of system components, refer to the document: *Site Planning Guide*.

The system includes the following components:

- A ZenoTOF 7600+ mass spectrometer.
- A roughing pump. The following roughing pump configurations are available:
 - One oil-sealed roughing pump
 - One dry roughing pump
- A Turbo V ion source that uses either the twin electrospray ionization (ESI) probe or the twin atmospheric pressure chemical ionization (APCI) probe. Refer to the document: *Turbo V Ion Source Operator Guide*.
- A SCIEX-supplied computer and monitor with the control software for instrument optimization, acquisition method development, data acquisition, and processing. For computer specifications and requirements, refer to the software documentation.

Hardware Overview

Figure 2-1 Front and Right Side View

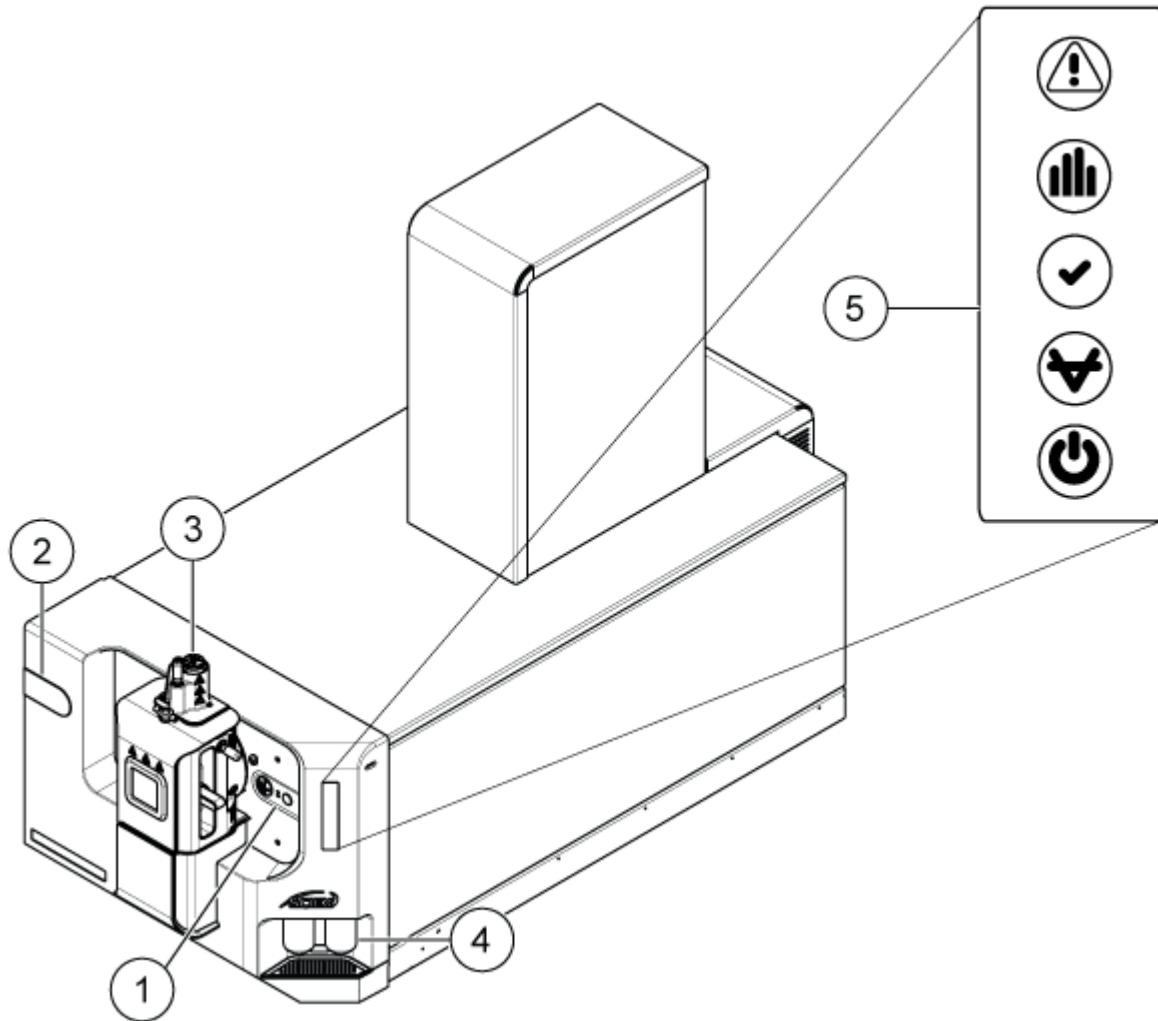

Item	Description
1	Diverter valve in standard location. Refer to the section: Diverter Valve .
2	Alternate (left) location for diverter valve. For more information, contact an FSE.
3	Ion source. Refer to the ion source document: <i>Operator Guide</i> .
4	Calibrant bottles. Refer to the section: Replace the CDS Bottle .

Principles of Operation

Item	Description
5	Panel symbols. Refer to the section: Panel Symbols .

Figure 2-2 Back and Left Side View

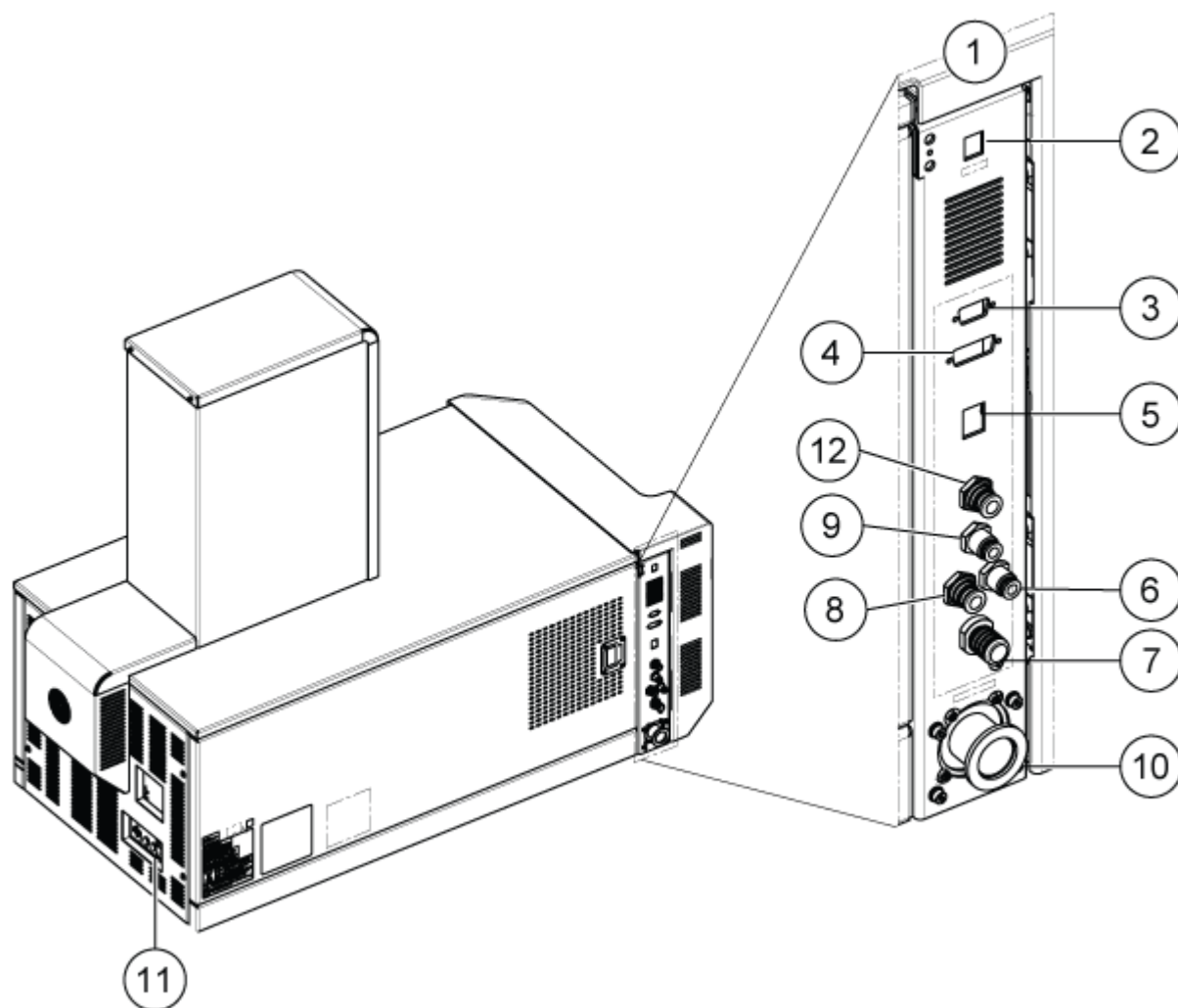





Item	Description
1	Left bulkhead. Contains the gas, vacuum, and communication connections.
2	Vent button. Refer to the section: Shut Down and Vent the System .
3	Column heater connection. Used to supply power to the ion source column heater, if power cannot be supplied by the LC system.

Item	Description
4	AUX IO connection. Not used.
5	Ethernet connection. Used for communication with the acquisition computer.
6	Zero air gas supply.
7	Exhaust waste. Refer to the section: Empty the Source Exhaust Drain Bottle .
8	Nitrogen gas supply.
9	Exhaust gas supply. The air supply for the ion source.
10	Vacuum hose connection for the roughing pump.
11	Mass spectrometer convenience switch. Refer to the section: Start Up the System or Shut Down and Vent the System .
12	Research Grade nitrogen gas supply. The gas supply for the Q2 collision cell.

Panel Symbols

The following table describes the mass spectrometer status LEDs.

Table 2-1 Panel Symbols

LED	Color	Name	Description
	Green	Power	Illuminated when the system is powered up.
	Green	Vacuum	Illuminated when the operating vacuum level has been achieved. Flashing if the vacuum is not at the correct level, that is, during pump down and venting.
	Green	Ready	Illuminated when the system is in the Ready state. The system must be in the Ready state to operate.
	Blue	Scanning	Flashing when the system is acquiring data.
	Red	Fault	Illuminated when the system encounters a system fault.

After the system is turned on, the power LED illuminates, and the fault LED flashes for a few seconds. Then the vacuum LED starts to flash. After the operating vacuum level is achieved, this LED remains illuminated.

Theory of Operation

Mass spectrometry measures the mass-to-charge ratio of ions to identify and quantify compounds.

The ZenoTOF 7600+ system has a series of quadrupole filters that select or transmit ions according to their mass-to-charge ratio (m/z). The first quadrupole in this series is the QJet ion guide, which is located between the orifice plate and the Q0 region. The QJet ion guide does not filter ions, but focuses them before they enter the Q0 region. By prefocusing the larger ion flux created by the wider orifice, the QJet ion guide increases instrument sensitivity and improves the signal-to-noise ratio. In the Q0 region, the ions are further focused before passing into the Q1 quadrupole.

The Q1 quadrupole works in two operational modes: TOF MS and TOF MS/MS.

- For TOF MS experiments, all ions across the experimental m/z range are passed through to the electron-activated dissociation (EAD) cell/Q2 collision cell.
- For TOF MS/MS experiments, only ions with specified mass-to-charge ratios are transmitted to the EAD cell/Q2 collision cell. All others are eliminated by defocusing away from the ion path axis.

After transmission through the Q1 quadrupole, ions are fragmented by either EAD or collisionally activated dissociation (CAD). In EAD mode, the precursor ions in the EAD cell are stored briefly and then exposed to electrons to promote electron-activated dissociation of the precursor ion to fragment ions. In CAD mode, fragment ions are created through vibrational excitation of the precursor ion resulting from collisions with gas molecules in the Q2 collision cell.

In both fragmentation modes, after passing through the Q2 collision cell, the ions enter the time-of-flight (TOF) analyzer for accurate mass measurement. After acceleration and focusing, ions fly through the flight chamber and reach the detector at different times depending on their mass-to-charge ratio. At the detector, impinging ions create an electrical pulse, the amplitude of which is directly proportional to the quantity of ions impacting the detector. The analog-to-digital convertor (ADC) measures both the time and amplitude of the signal from the detector, which translate, respectively, to a mass-to-charge ratio and signal intensity. The software converts this data to mass spectra that can be observed by the user.

The Zeno trap is a patented technology that permits total recovery of duty cycle losses for all ions in TOF mass spectrometry. At this time, it is applied in MSMS mode only. When the Zeno trap is active, ions that are usually lost between TOF pulses are stored in the Q2 collision cell. At the appropriate time, they are released in a mass-dependent fashion (high- m/z ions first). As a result, all masses arrive almost simultaneously at the accelerator, to be pulsed into the TOF. This process eliminates the duty cycle losses that occur during normal operation without the Zeno trap because ions are not sampled between TOF pulses. With CAD fragmentation, the Zeno trap pulsing is applied on a data-dependent, on-demand basis. With EAD fragmentation, pulsing is applied full time.

Operating Instructions — Hardware 3



WARNING! Personal Injury Hazard. To use the system safely, follow the instructions in the documentation. If the equipment is used in a manner not specified by SCIEX, then the protection supplied by the equipment might be decreased.

Start Up the System



WARNING! Electrical Shock Hazard. Make sure that the system can be disconnected from the mains supply outlet in an emergency. Do not block the mains supply outlet.

Note: Before operation of the system, read the safety information in the section: [Operational Precautions and Limitations](#).

Prerequisites

- The site requirements specified in the *Site Planning Guide* are met. The *Site Planning Guide* includes information about the requirements for the mains supply and connections, compressed air, nitrogen, roughing pump, ventilation, exhaust, and site clearance. If required, then contact SCIEX for a copy of the *Site Planning Guide*. For contact information, go to sciex.com/contact-us.
- A separate, dedicated source of high-purity, research-grade nitrogen (99.996%) is available. A separate gas cylinder is recommended. A separate source of nitrogen is required to prevent the system from becoming contaminated while operating in EAD mode.
- The source exhaust gas, compressed air, and nitrogen gases are connected to the mass spectrometer.
- The 4 L source exhaust drain bottle is connected to the exhaust waste connection of the mass spectrometer and to the laboratory ventilation system.
- The source exhaust hoses are securely clamped at the mass spectrometer, source exhaust drain bottle, and ventilation connections.
- Exhaust hoses from the roughing pumps have been connected to the laboratory ventilation system.
- The mass spectrometer convenience switch is turned off and the mains supply cable is connected to the mass spectrometer.
- The mass spectrometer and roughing pump mains supply cables are connected to the 200 VAC to 240 VAC mains supply.
- The Ethernet cable is connected to both the mass spectrometer and the computer.

1. Turn on the roughing pump.

Oil-sealed roughing pump: Turn on the On/Off switch beside the mains supply input connection on the roughing pump.

Figure 3-1 Oil-Sealed Roughing Pump: On/Off Switch



Dry pump: Make sure that the circuit breaker on the back of the pump is turned on, and then press the Start button on the front panel.

Figure 3-2 Dry Pump, Front and Back

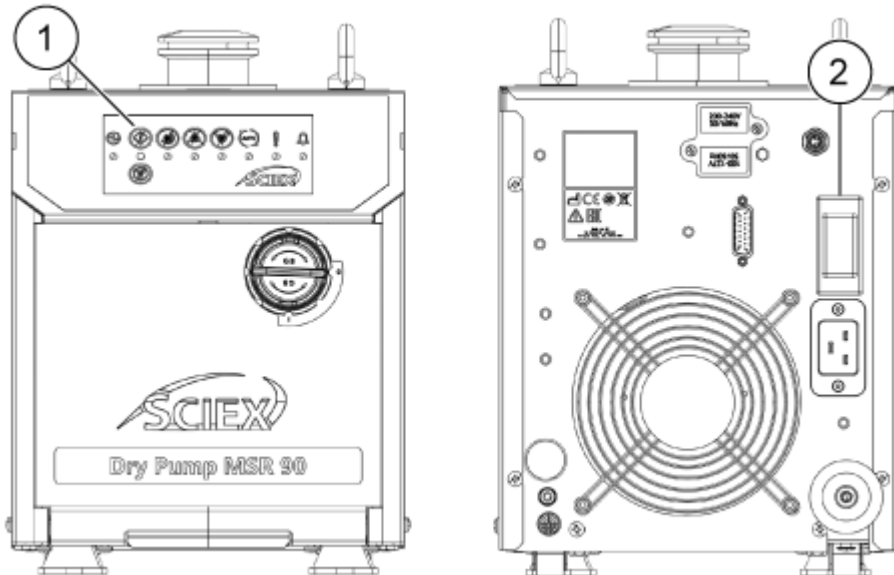

Item	Description
1	Start button

Item	Description
2	Circuit breaker

2. Turn on the mass spectrometer convenience switch. Refer to the figure: [Figure 2-2](#).
3. Turn on the computer.
4. Open the SCIEX OS software.

After Venting the Mass Spectrometer

- Do a Quick Status Check in the MS Tune workspace of the SCIEX OS software. Refer to the document: *Help System*.
- If resolution drift occurs 16 to 24 hours after startup, then perform a Quick Status Check again.

Shut Down and Vent the System

Some procedures require that the system be shut down, that is that the power to the system be turned off. Others require that it be *vented*, that is, that the vacuum pressure be released. Follow these steps to shut the system down or release the pressure, as required.

Note: If the input gas supply must be disconnected, then relieve the pressure in the gas lines before disconnecting it.

Tip! If the mass spectrometer will not be used for an extended period, then leave it in Standby state with the ion source in position. If the mass spectrometer must be shut down, then follow these instructions.

1. Complete or stop any ongoing scans.

CAUTION: Potential System Damage. Turn off the sample flow before the system is shut down.

2. Turn off the sample flow to the system.
3. Deactivate the devices, if they are active.
4. Close the control software.
5. (If required) To vent the system, do these steps:

Note: Vent the system before performing a full cleaning of the vacuum interface, before cleaning the Q0 region, and before replacing the roughing pump oil. For more information, contact the qualified maintenance person (QMP) or FSE.

- a. Press and hold the **Vent** button for 3 seconds.
-

The Vacuum LED begins flashing more quickly than during pump down. The turbo pump spins down gradually.

- b. Turn off the roughing pump.
 - c. Let the system vent for 20 minutes.
6. After the Vacuum light stops blinking, turn off the mass spectrometer convenience switch. Refer to the figure: [Figure 2-2](#).
 7. Disconnect the mass spectrometer mains supply cable from the mains supply outlet.

Figure 3-3 Cable Connections

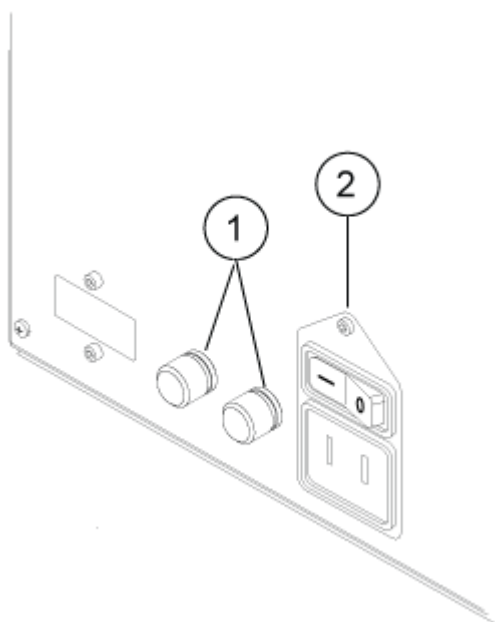

Item	Description
1	Fuse (12.5 A, fast acting, 5 x 20 mm)
2	Mains supply cable connector

8. (If venting the system) Disconnect the mains supply cable for the roughing pump from the mains supply outlet.
9. If the mass spectrometer will be vented and out of service for more than 8 hours, then turn off both nitrogen gas supplies.
Unless the gas supply is turned off, nitrogen gas will continue to flow through the curtain plate at a rate of 4 L/min when the instrument is shut down and vented.

Diverter Valve

The diverter valve is a two-position, six-port valve. It can be plumbed in Injector mode or Diverter mode. In Injector mode, it can be configured with a sample loop for sample injection. In Diverter mode, it can be configured to divert sample to waste at the beginning of each LC run.

CAUTION: Potential Wrong Result. Do not press the diverter valve button during a run. Doing so might result in incorrect data.

Plumb the Diverter Valve in Injector Mode

When the valve is in position A, the sample flows through the external loop. When the valve changes to position B, the sample is injected.

- Plumb the valve for Injector mode.

Figure 3-4 Diverter Valve—Injector Mode Position A

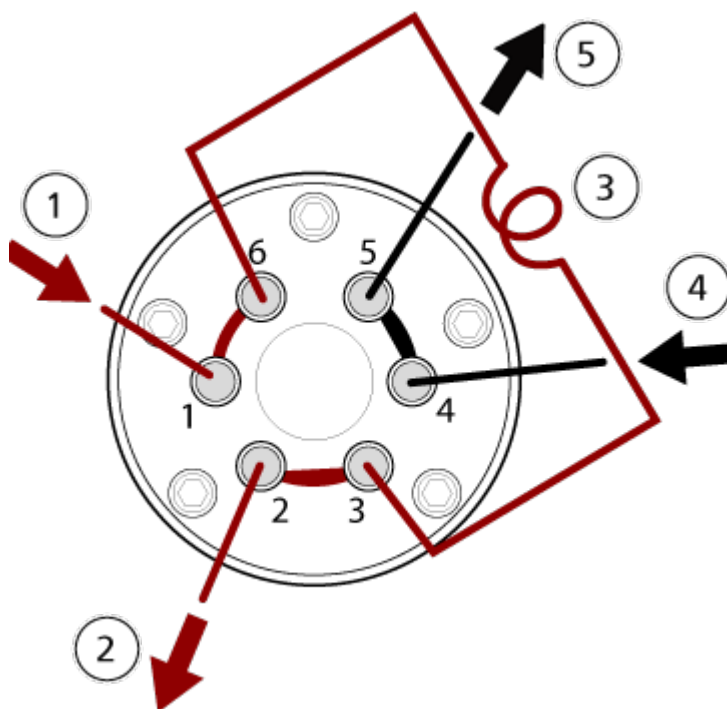
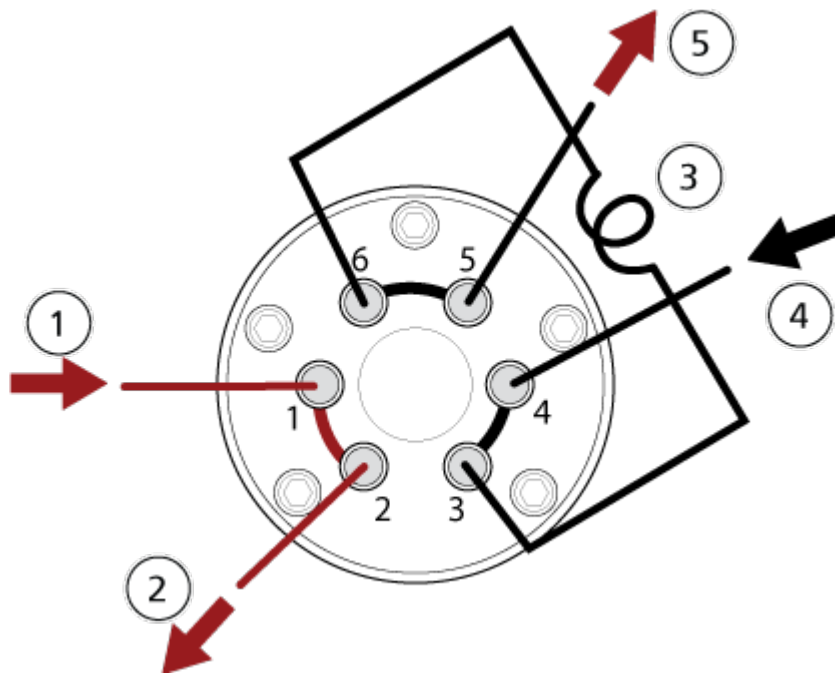

Figure 3-5 Diverter Valve—Injector Mode Position B



Item	Description
1	Sample in
2	Waste out
3	Sample loop (ports 3 and 6)
4	Mobile phase in
5	To the column, or to the mass spectrometer, if a column is not installed

Plumb the Diverter Valve in Diverter Mode

When the valve is in position A, the sample flow goes to the mass spectrometer. When the valve changes to position B, the flow goes to waste.

- Plumb the valve for Diverter mode.

Figure 3-6 Diverter Valve—Diverter Mode Position A

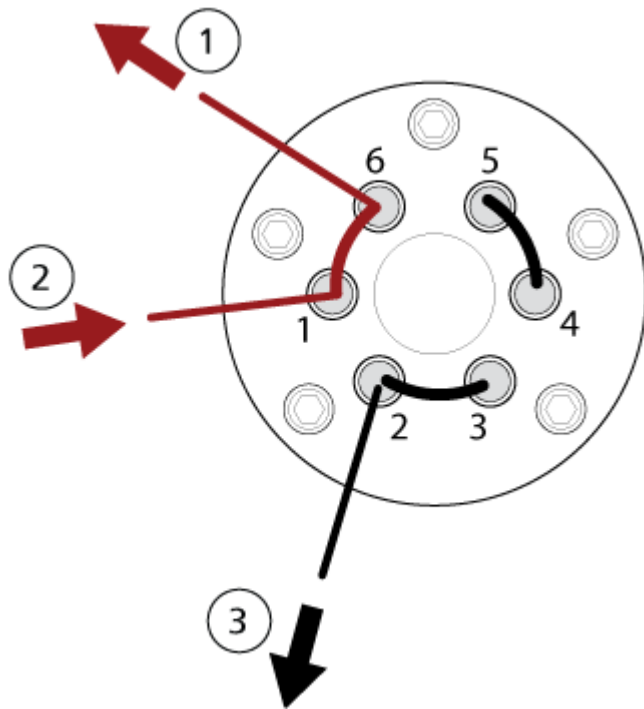
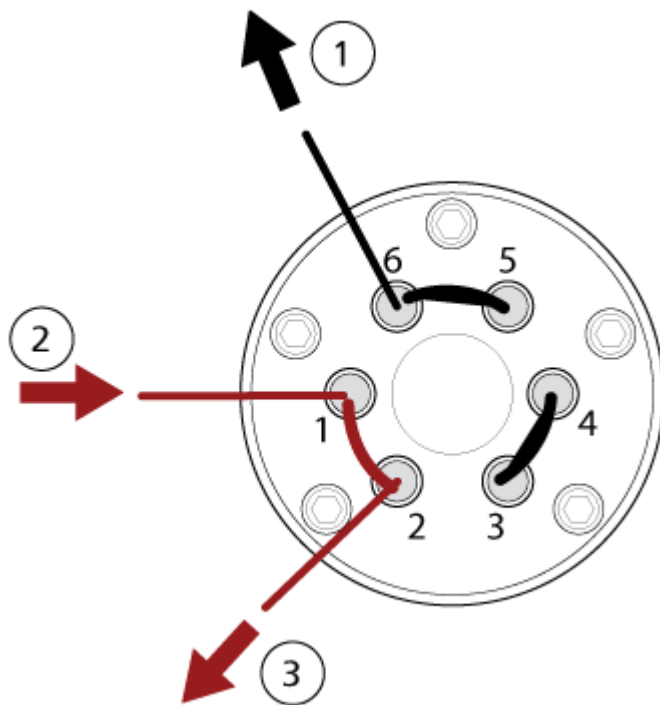

Figure 3-7 Diverter Valve—Diverter Mode Position B



Item	Description
1	To the mass spectrometer
2	From the column
3	Waste out

Calibrant Delivery System

The calibrant delivery system (CDS) introduces calibration solution for automated mass calibration of the mass spectrometer, to make sure that the mass accuracy of the system is maintained throughout batch acquisition.

Because calibration only takes about a minute and a half, we recommend frequent calibration.

Replace the CDS Bottle



WARNING! Toxic Chemical Hazard. Refer to the chemical product safety data sheets and follow all of the recommended safety procedures when handling, storing, and discarding chemicals.

The CDS supports up to two bottles of calibrant. Use bottle one for the positive calibrant solution. Use bottle two for the negative calibrant solution. Be sure to install the bottle in the correct position to avoid cross-contamination.

1. Turn the bottle counter-clockwise to remove it from the CDS.
2. Turn the new bottle clockwise to install it.

Start the CDS

Use the direct control function to start the CDS manually when flushing the CDS or when introducing solutions during tuning.

1. In the SCIEX OS software, on the status panel, click  (Direct CDS control).

Figure 3-8 Device Control Dialog

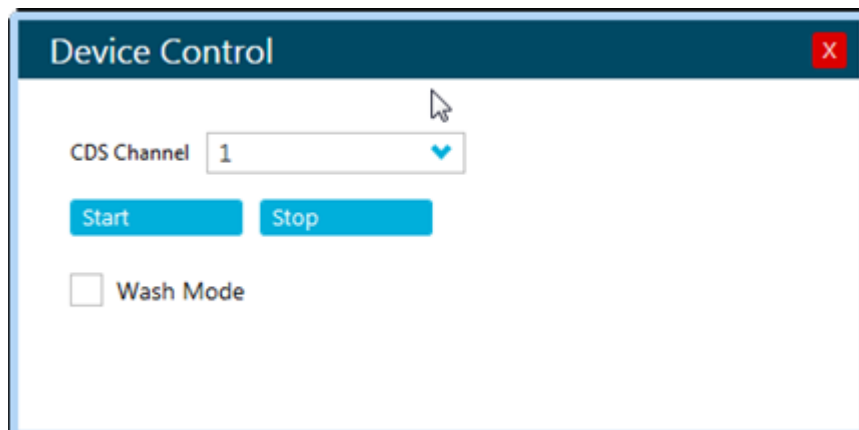

2. Click **Start**.

Stop the CDS

1. In the SCIEX OS software, on the status panel, click  (**Direct CDS control**).
2. Click **Stop**.

Flush the CDS



WARNING! Toxic Chemical Hazard. Refer to the chemical product safety data sheets and follow all of the recommended safety procedures when handling, storing, and discarding chemicals.

Before a different calibrant solution is installed, make sure to flush the CDS tubing to remove any calibrant. This procedure applies to both CDS bottles.

Required Materials

- Bottle of wash solution (1:1 water:acetonitrile)
- Waste container

Tip! To prevent waste contamination in the intake tubing, use the calibrant bottle, not a waste bottle, to do step 1 to step 4.

1. Remove the calibrant bottle and lower it so that both ends of tubing are not submerged in the liquid.

2. Put both ends of the calibrant tubing in a waste container, taking care not to submerge the tubing in liquid.
The container must hold at least 20 mL of additional solution that might come out of the instrument.
3. In the SCIEX OS software, follow these steps to put the CDS in Wash mode:

- a. On the status panel, click  (**Direct CDS control**).

Figure 3-9 Device Control Dialog

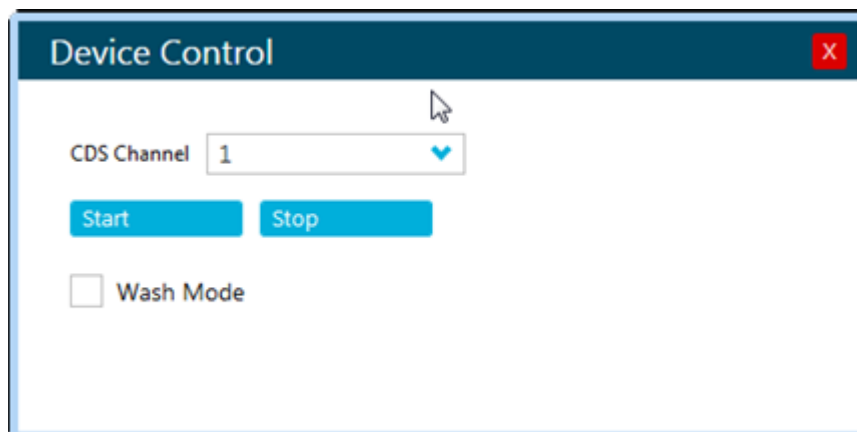

- b. Select the **Wash Mode** check box.
This allows the pump to be controlled through the bottle sensor, which is located behind the bottle position.
4. To start the pump, press and hold the bottle sensor switch for 1 minute.
The CDS draws in air and discharges liquid. To stop the pump, stop pressing the switch.

Figure 3-10 Bottle Sensor Switch

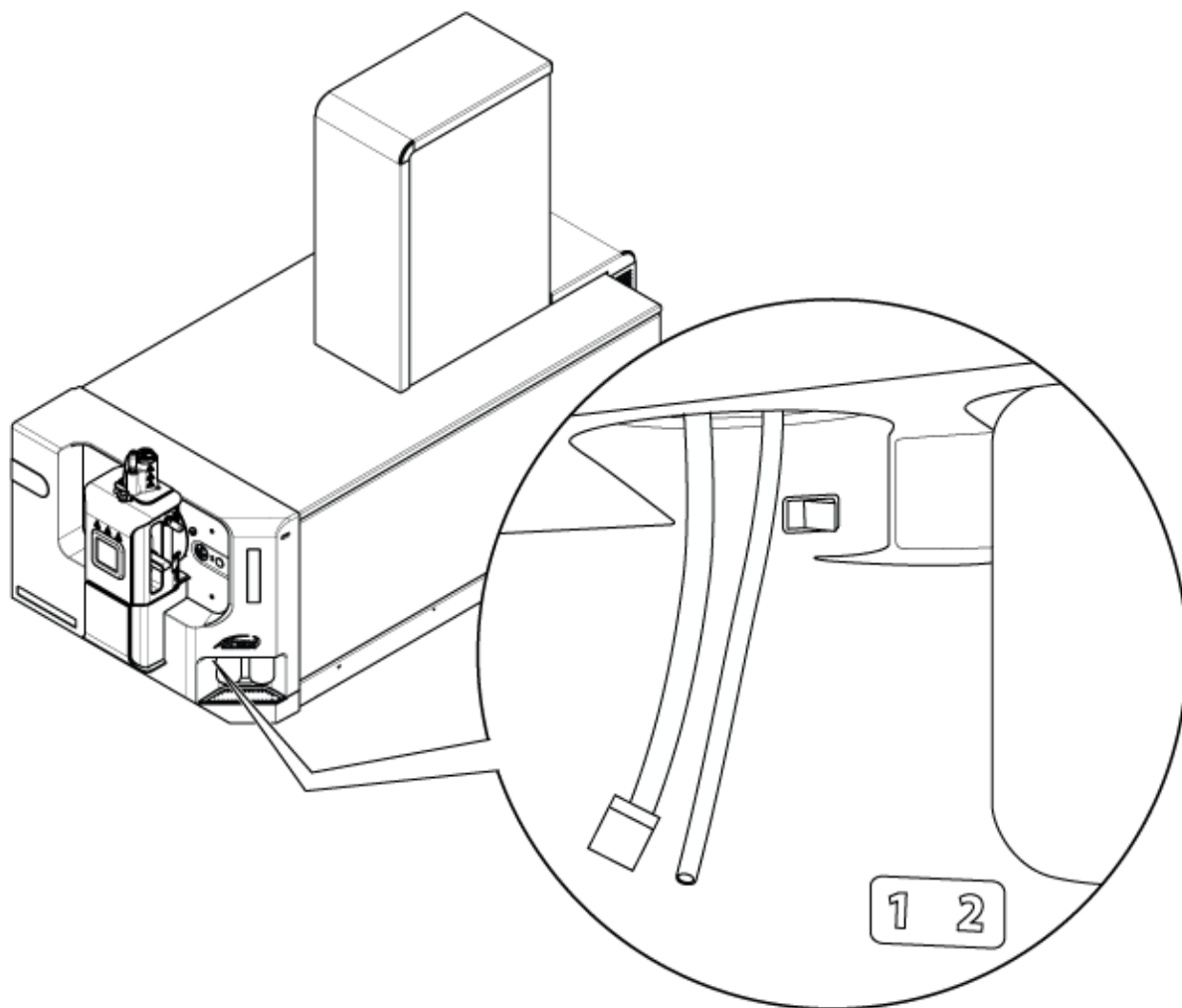

5. Discard the waste.
6. Put the intake (longer) tube in the bottle of wash solution.
7. Put the return (shorter) tube in the waste bottle.
8. Make sure that the software is still in Wash mode.
9. Press the bottle sensor switch for 1 minute or until 20 mL of solvent accumulates into the waste container.
10. Discard the waste.
11. Do step 2 to step 5 again to purge the wash solution.

12. (Optional) Do step 6 to step 9 again to flush the CDS with the new calibrant, putting the intake tube in the new bottle of calibrant solution. To conserve sample, purge for only 10 seconds, or until 2 mL to 3 mL of solution collects in the waste container.

Tip! We recommend that the tubing be flushed with the new calibrant solution before the new calibrant is permitted to recirculate back into the calibrant bottle.

13. Clear the **Wash Mode** check box.
14. Put the return tubing into the calibrant bottle, and then install the bottle.

Operating Instructions — User Workflows

4

After the system is installed and configured, it is ready for use. The following table shows the workflows available. For each task, a reference that contains more information is listed.

Table 4-1 User Workflows

Task	Reference
Analyst	
Monitor the system status	<i>Help System</i>
Create and submit batches	<i>Help System</i>
View and manage samples in the queue	<i>Help System</i>
Explore data	<i>Help System</i>
Method Developer	
Configure the system	<ul style="list-style-type: none">• Configure the mass spectrometer: <i>Help System</i>• Create projects and data folders: <i>Help System</i>• Configure the LC devices: <i>Help System</i>
Tune the mass spectrometer	<i>Help System</i>
Create MS methods	<i>Help System</i>
Create LC methods	<i>Help System</i>
Develop processing methods	<i>Help System</i>
Administrator	
Set the Windows file permissions	<i>Laboratory Director Guide</i>
Configure the LIMS	<i>Help System.</i>
Add users to the software and assign roles	<i>Laboratory Director Guide or Help System</i>
Archive logs	<i>Help System</i>
Reviewer	
Review processed results	<i>Help System</i>

Table 4-1 User Workflows (continued)

Task	Reference
Explore data	<i>Help System</i>
Review logs	<i>Help System</i>

Service and Maintenance Information

5

Regularly clean and maintain the system for optimal performance.



WARNING! Electrical Shock Hazard. Do not remove the covers. If the covers are removed, then injury or incorrect system operation can occur. Removal of the covers is not required for routine maintenance, inspection, or adjustment. Contact a SCIEX field service employee (FSE) for repairs that require removal of the covers.



WARNING! Ionizing Radiation Hazard, Biohazard, or Toxic Chemical Hazard. Before cleaning or maintenance, identify whether decontamination is required. If radioactive materials, biological agents, or toxic chemicals have been used with the system, then the customer must decontaminate the system before cleaning or maintenance.

Recommended Maintenance Schedule

The following tables provide a recommended schedule for cleaning and maintaining the system.

Tip! Do maintenance tasks regularly to make sure that system performance is optimal.

- Do periodic gas leakage tests and general maintenance inspections to make sure that system operation is safe.
- Clean the system regularly to keep it in good working condition.
- During system maintenance, carefully examine parts of the external gas supply system, including tubing that is connected to the equipment, to make sure that the condition is satisfactory. Replace tubing that is collapsed or that has cracks or pinches.

For information about maintaining the ion source, refer to the document: *Turbo V Ion Source Operator Guide*.

To determine how often to clean or do maintenance on the mass spectrometer and ion source, consider the following factors. These factors can cause changes in mass spectrometer performance, indicating that maintenance is required.

- Compounds tested
- Cleanliness of the samples and the sample preparation methods
- Amount of time that the probe is exposed to the sample

- Overall system run time

To order consumable parts and for basic service and maintenance requirements, contact a QMP or refer to the document: *Parts and Equipment Guide*. Contact a SCIEX FSE for all other service and maintenance requirements.

Table 5-1 Mass Spectrometer Maintenance Tasks

Component	Frequency	Task	For More Information
System	Daily	Examine for leaks	Refer to the section: Chemical Precautions .
Curtain plate	Daily	Clean	Refer to the section: Clean the Curtain Plate .
Oil-sealed roughing pump ¹ : Roughing pump oil	Weekly	Examine the level	Refer to the section: Inspect the Roughing Pump Oil Level (Oil-Sealed Roughing Pump) . Contact the local QMP or FSE to add oil, if required.
Oil-sealed roughing pump ¹ : Roughing pump oil	Every 3 years, or as needed	Replace	Contact the local QMP or FSE.
Oil-sealed roughing pump ¹ : Roughing pump oil	As needed	Refill	Contact the local QMP or FSE.
Orifice plate (front)	As needed	Clean	Refer to the section: Clean the Front of the Orifice Plate .
Orifice plate (front and back)	As needed	Clean	Contact the local QMP or FSE.
QJet ion guide	As needed	Clean	Contact the local QMP or FSE.
Q0 rod set and IQ1 lens	As needed	Clean	Contact the local QMP or FSE.
Instrument surfaces	As needed	Clean	Refer to the section: Clean the Surfaces .
Source exhaust drain bottle	As needed	Empty	Refer to the section: Empty the Source Exhaust Drain Bottle .
Interface heater	As needed	Replace	Contact the local QMP or FSE.
CDS bottle	As needed	Replace or refill	Refer to the section: Replace the CDS Bottle .

¹ This procedure is not applicable for the dry roughing pump.

Service and Maintenance Information

Table 5-1 Mass Spectrometer Maintenance Tasks (continued)

Component	Frequency	Task	For More Information
CDS flow module	As needed	Replace	Refer to the section: Replace the Check Valve and Flow Module .
CDS filters	As needed	Replace	Refer to the section: Replace the CDS Bottle Intake Filters

Table 5-2 Ion Source Maintenance Tasks

Component	Frequency	Task	For More Information
Ion source probes	As required	Examine and replace	Refer to the document: <i>Turbo V Ion Source Operator Guide</i> .
Electrodes for the twin ESI or APCI probes	As required	Examine and replace	Refer to the document: <i>Turbo V Ion Source Operator Guide</i> .
Corona discharge needle	As required	Replace	Refer to the document: <i>Turbo V Ion Source Operator Guide</i> .
Turbo heater	As required	Replace	Contact the local QMP or FSE.
Sample tubing	As required	Replace	Refer to the document: <i>Turbo V Ion Source Operator Guide</i> .

For “As needed” tasks, follow these guidelines:

- Clean the mass spectrometer surfaces after a spill or when they become dirty.
- Empty the source exhaust drain bottle before it becomes full.
- Clean the orifice plate, QJet ion guide, and Q0 region if system sensitivity degrades.

Tip! Clean the Q0 region regularly to minimize the impact of charging, a significant loss of sensitivity of the ions of interest over a short period of time, on the quadrupoles and lenses. Contact a QMP or FSE.

- Oil-sealed roughing pump: Refill the oil when the oil falls below the minimum oil level.
- Examine all of the exhaust connections at regular intervals to make sure that the integrity is maintained, and that any exhaust is removed from the customer lab.

Clean the Surfaces

Clean the external surfaces of the mass spectrometer after a spill or when they become dirty.

CAUTION: Potential System Damage. Use only the recommended cleaning methods and materials to avoid damaging the equipment.

1. Wipe the external surfaces with a soft cloth dampened with warm, soapy water.
2. Wipe the external surfaces with a soft cloth dampened with water to remove any soap residue.

Clean the Front End

The following warning applies to all of the procedures in this section:



WARNING! Hot Surface Hazard. Let the Turbo V ion source cool for at least 30 minutes before starting any maintenance procedures. Some surfaces of the ion source and vacuum interface become hot during operation.

Clean the mass spectrometer front end using the routine cleaning method, to:

- Minimize unscheduled system downtime.
- Maintain optimum sensitivity.
- Avoid more extensive cleaning that requires a service visit.

When contamination occurs, perform an initial routine cleaning. Clean up to and including the front of the orifice plate. If routine cleaning does not resolve issues with sensitivity, then a full cleaning might be necessary.

This section supplies instructions for performing routine cleaning without breaking vacuum.

Note: Follow all of the applicable local regulations. For health and safety guidelines, refer to the section: [Chemical Precautions](#).

Symptoms of Contamination

The system might be contaminated if any one of the following is observed:

- Significant loss in sensitivity
- Increased background noise
- Additional peaks that are not part of the sample in full scan or survey scan methods

If any of these issues are observed, then clean the mass spectrometer front-end.

Required Materials

The following materials are required to do routine cleaning:

- Powder-free gloves, nitrile or neoprene recommended
-

Service and Maintenance Information

- Protective eyewear
- Laboratory coat
- New LC-MS–grade water

Note: Old water can contain contaminants.

- Cleaning solution, either:
 - 100% LC-MS–grade methanol
 - 100% LC-MS–grade isopropanol (2-propanol)
- Clean 1 L or 500 mL glass beaker to prepare cleaning solutions
- 1 L beaker to collect used solvent
- Organic waste container
- Lint-free wipes. Refer to the section: [Tools and Supplies Available from the Manufacturer](#).
- (Optional) Polyester (poly) swabs. Refer to the section: [Tools and Supplies Available from the Manufacturer](#).

Tools and Supplies Available from the Manufacturer

Note: For part numbers, refer to the document: *Parts and Equipment Guide*.

- Small poly swab, thermally bonded. Also available in the Cleaning kit.
- Lint-free wipe (11 cm x 21 cm, 4.3 inches x 8.3 inches). Also available in the Cleaning kit.

Cleaning Best Practices



WARNING! Hot Surface Hazard. Let the Turbo V ion source cool for at least 30 minutes before starting any maintenance procedures. Some surfaces of the ion source and vacuum interface become hot during operation.



WARNING! Toxic Chemical Hazard. Refer to the chemical product safety data sheets and follow all of the recommended safety procedures when handling, storing, and disposing of chemicals.



WARNING! Ionizing Radiation Hazard, Biohazard, or Toxic Chemical Hazard. Before cleaning or maintenance, identify whether decontamination is required. If radioactive materials, biological agents, or toxic chemicals have been used with the system, then the customer must decontaminate the system before cleaning or maintenance.



WARNING! Environmental Hazard. Do not discard system components in municipal waste. To discard components correctly, obey local regulations.

- Let the ion source cool before removing it.
- Always wear clean, powder-free gloves, nitrile or neoprene recommended, for the cleaning procedures.
- After cleaning the mass spectrometer components, and before reassembling them, put on a new, clean pair of gloves.
- Do not use cleaning supplies other than those specified in this procedure.
- If possible, prepare cleaning solutions just before cleaning.
- Prepare and store all of the organic solutions and organic-containing solutions in very clean glassware only. Never use plastic bottles. Contaminants can leach from these bottles and cause more contamination the mass spectrometer.
- To prevent contamination of the cleaning solution, pour the solution on the wipe or swab.
- Let only the center area of the wipe touch the mass spectrometer surface. Cut edges can leave fibers behind.

Tip! Wrap the wipe around a thermally-bonded poly swab.

Figure 5-1 Example: Folding the Wipe



- To avoid cross-contamination, discard the wipe or swab after it has touched the surface once.
- If required, use multiple wipes to clean larger parts of the vacuum interface, such as the curtain plate, multiple times.
- Only dampen the wipe or swab slightly during application of water or cleaning solution. Water might cause the wipe to deteriorate, and thus leave residue on the mass spectrometer.
- Do not rub the wipe across the aperture. Wipe around the aperture to prevent fibers from the wipes from going into the mass spectrometer.
- Do not insert the brush in the aperture on the curtain plate or orifice plate.

Prepare the Mass Spectrometer



WARNING! Hot Surface Hazard. Let the Turbo V ion source cool for at least 30 minutes before starting any maintenance procedures. Some surfaces of the ion source and vacuum interface become hot during operation.

CAUTION: Potential System Damage. Do not let anything fall in the source drain when the ion source is removed.

Figure 5-2 Source Drain on the Vacuum Interface

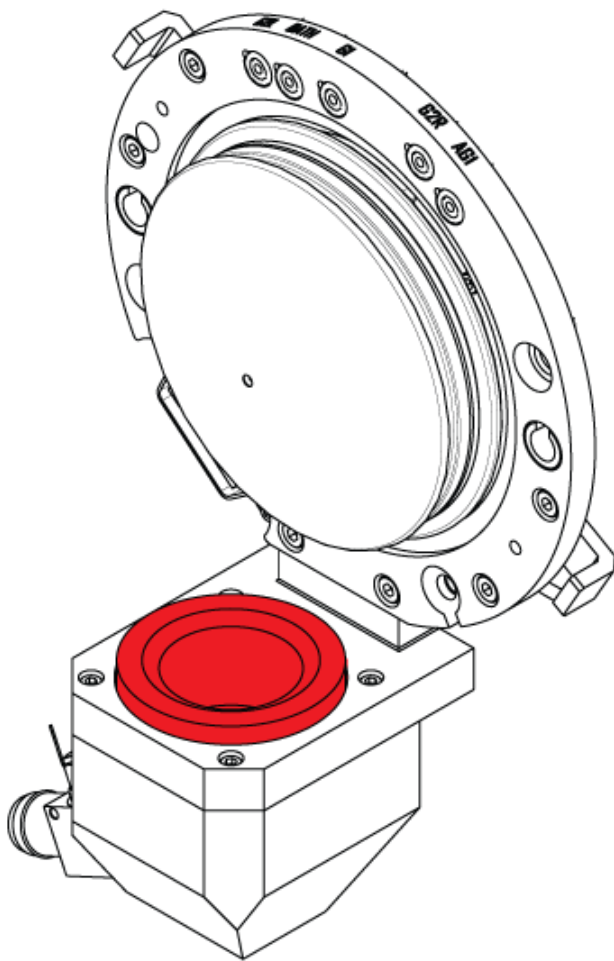

-
1. Deactivate the devices in the SCIEX OS software. Refer to the document: *Help System*.
 2. Remove the ion source. Refer to the ion source document: *Operator Guide*.
When the ion source is not in use, store it to protect it from damage and to maintain operating integrity.
-

Clean the Curtain Plate

CAUTION: Potential System Damage. When the curtain plate or orifice plate is put on a surface, do not let the aperture tip touch the surface. Make sure that the conical side of the curtain plate points up.

CAUTION: Potential System Damage. To prevent damage to the aperture, do not put a wire or metal brush in the aperture on the curtain plate, orifice plate, interface heater, or IQ0 lens.

1. Pull the curtain plate off of the vacuum interface and then put it, conical side up, on a clean, stable surface.

Figure 5-3 Curtain Plate Removal

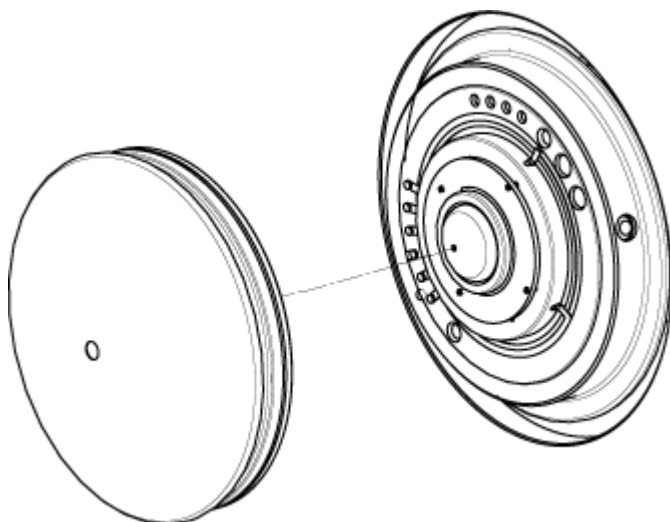

The curtain plate is held in place by three retaining ball catches mounted on the orifice plate.

Tip! If the curtain plate does not immediately separate from the orifice plate, then turn the curtain plate slightly, less than 90 degrees, to release the ball spring latches.

2. Dampen a lint-free wipe with LC-MS-grade water and then clean both sides of the curtain plate.
-

Note: Use multiple wipes, as required.

3. Repeat step 2 using the cleaning solution.
 4. Using a dampened wipe or small poly swab, clean the aperture.
 5. Wait until the curtain plate is dry.
-

Service and Maintenance Information

6. Inspect the curtain plate for solvent stains or lint, removing any residue with a clean, slightly damp, lint-free wipe.

Note: Persistent spotting or filming is an indicator of contaminated solvent.

Clean the Front of the Orifice Plate

CAUTION: Potential System Damage. Do not remove the interface heater to clean the surface of the orifice plate. Frequent removal of the interface heater can cause damage. Surface cleaning of the interface heater is sufficient for routine cleaning.

CAUTION: Potential System Damage. To prevent damage to the aperture, do not put a wire or metal brush in the aperture on the curtain plate, orifice plate, interface heater, or IQ0 lens.

CAUTION: Potential System Contamination. Make sure that the system is fully vented. If the system is cleaned while it is under vacuum, then dirt or debris, such as pieces of wipe, might go into the mass spectrometer.

Note: Do not use SCIEX Cleaning Powder to clean the orifice plate while it is installed on the mass spectrometer.

1. Vent the system. System shutdown is not required. Refer to the section: [Shut Down and Vent the System](#).
2. Dampen a poly swab with LC-MS–grade water, and then wipe the front of the orifice plate and the interface heater.
3. Do step 2 again with the isopropanol or methanol.
4. Wait until the orifice plate is dry.
5. Examine the orifice plate for solvent stains or lint. Use a clean, moist, lint-free wipe to remove any residue.

Note: Persistent spotting or filming is an indicator of contaminated solvent.

Put the Mass Spectrometer Back in Service

1. Install the curtain plate.
2. Install the ion source on the mass spectrometer. Refer to the ion source document: *Operator Guide*.
Tighten the ion source by turning the source latches down in the locking position.
3. Activate the devices in the SCIEX OS software. Refer to the document: *Help System*.

Empty the Source Exhaust Drain Bottle



WARNING! Hot Surface Hazard. Let the Turbo V ion source cool for at least 30 minutes before starting any maintenance procedures. Some surfaces of the ion source and vacuum interface become hot during operation.



WARNING! Ionizing Radiation Hazard, Biohazard, or Toxic Chemical Hazard. Deposit hazardous materials in appropriately labeled waste containers and dispose of them according to local regulations.



WARNING! Ionizing Radiation Hazard, Biohazard, or Toxic Chemical Hazard. Take care to vent exhaust gases to a dedicated laboratory fume hood or exhaust system and make sure that the ventilation tubing is secured with clamps. Make sure that the laboratory has correct air exchange for the work performed.

Note: Make sure that there are no kinks, sags, or twists in the source waste line.

Inspect the source exhaust drain bottle regularly, and empty it before it becomes full. Also inspect the bottle and the fitting for leaks, and tighten connections or replace components, if required. Follow the steps in this procedure to empty the bottle.

1. Remove the ion source. Refer to the document: *Turbo V Ion Source Operator Guide*.
2. Loosen the clamps connecting the hoses to the cap of the source exhaust drain bottle.

Figure 5-4 Source Exhaust Drain Bottle

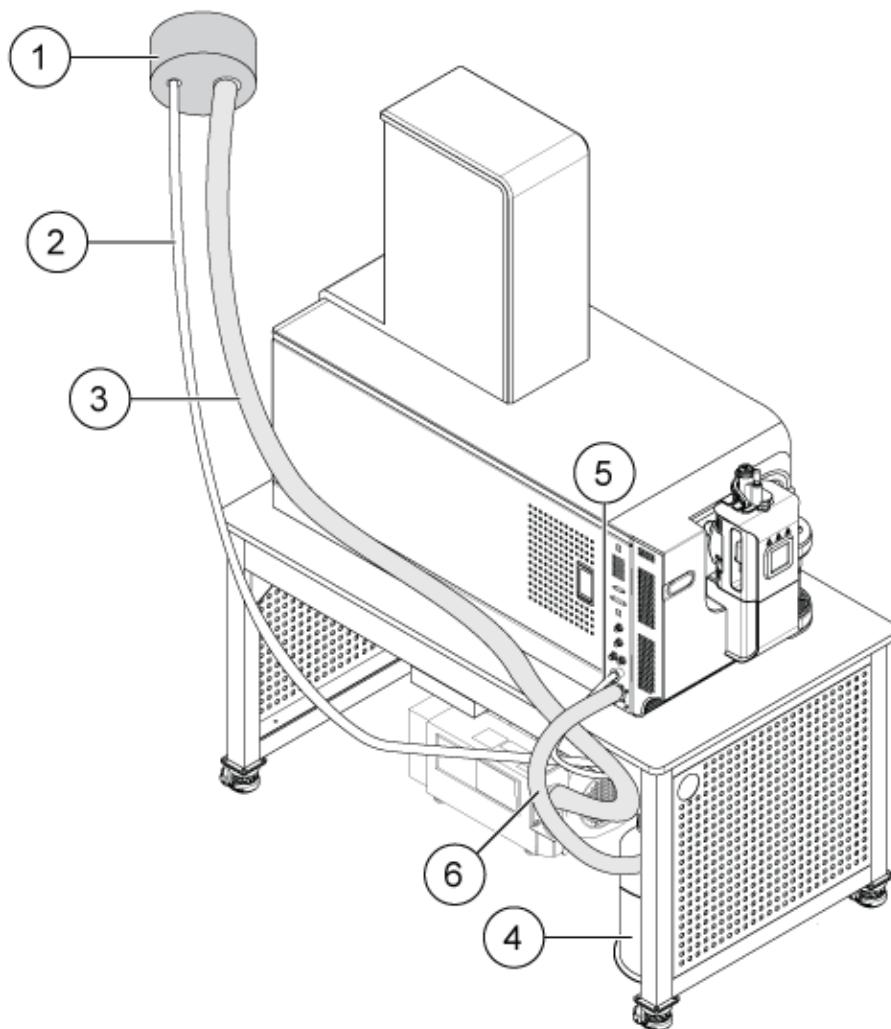

Item	Description
1	Connection to vent
2	Source exhaust drain tubing: 2.5 cm (1.0 inch) inner diameter (i.d.)
3	Roughing pump exhaust hose: 3.2 cm (1.25 inch) i.d.
4	Source exhaust drain bottle Make sure that the bottle is secured to prevent spillage.
5	Source exhaust connection to the mass spectrometer: 1.6 cm (0.625 inch) i.d.

Item	Description
6	Roughing pump vacuum inlet hose.

Note: Source exhaust hose connections at the drain bottle, mass spectrometer, and laboratory vent are attached with hose clamps.

3. If applicable, lift the drain bottle out of the holder.
4. Disconnect the hoses from the cap.
5. Remove the cap from the drain bottle.
6. Empty the drain bottle and then dispose of the waste according to laboratory procedures and local waste regulations.
7. Install the cap on the bottle and then put the bottle in the holder.
8. Attach the hoses to the cap and then secure them tightly with clamps.

Replace the Check Valve and Flow Module



WARNING! Toxic Chemical Hazard. Refer to the chemical product safety data sheets and follow all of the recommended safety procedures when handling, storing, and discarding chemicals.

The check valve prevents calibrant from flowing into the ion source when the CDS is off. The flow module is a dimension-critical 10 cm length of black tubing that controls the flow rate of the calibrant into the ion source.

Figure 5-5 Check Valve and Flow Module

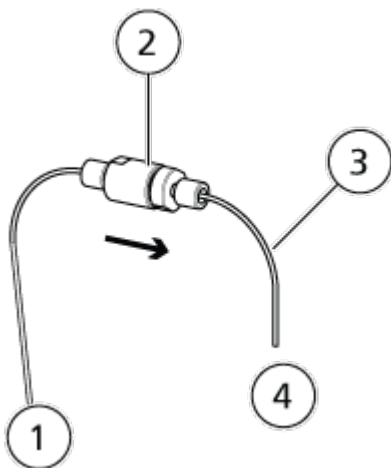

Service and Maintenance Information

Item	Description
1	To the CDS
2	Check valve
3	Flow module
4	To the ion source

Required Materials

- 1/4 inch wrench

1. To remove the check valve, loosen the finger-tight PEEK fittings on both sides of the check valve.

Note: When installing the check valve, make sure that the arrow on the check valve points toward the ion source.

2. To remove the flow module, follow these steps:
 - a. Loosen the finger-tight PEEK fitting that connects the flow module to the check valve.
 - b. Use a 1/4 wrench to remove the fitting that connects the flow module to the probe.

Replace the CDS Bottle Intake Filters



WARNING! Toxic Chemical Hazard. Refer to the chemical product safety data sheets and follow all of the recommended safety procedures when handling, storing, and discarding chemicals.

Figure 5-6 Intake Filters

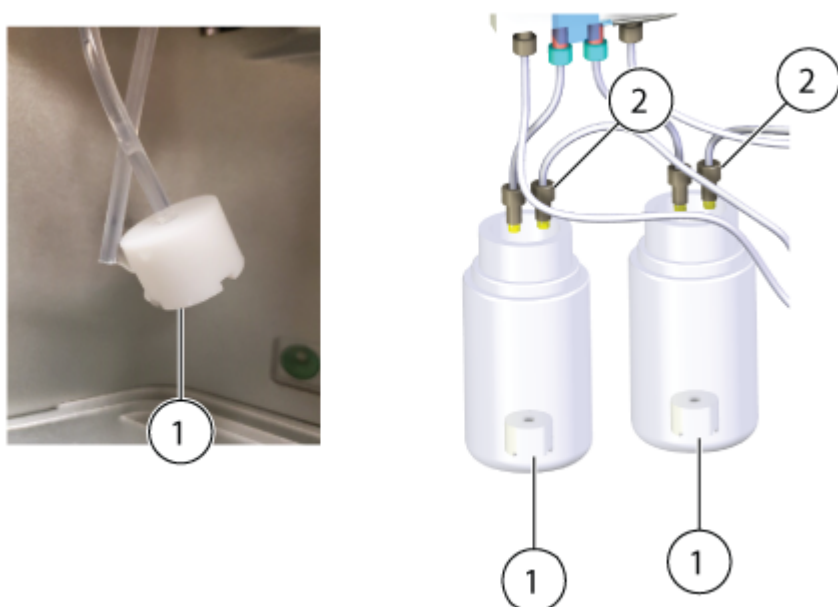

Item	Description
1	Intake filter
2	Intake tubing

1. Turn the CDS bottle counterclockwise to remove it from the CDS.
2. Remove the tubing from the bottle, and then gently pull the intake filter off of the tubing.
3. Install a new intake filter.
4. Install the CDS bottle in the CDS.

Inspect the Roughing Pump Oil Level (Oil-Sealed Roughing Pump)

- Inspect the sight glass on the roughing pump to make sure that the oil is above the minimum level.

If the oil is below the minimum level, then contact the qualified maintenance person (QMP) or SCIEX field service employee (FSE).

Figure 5-7 Sight Glass

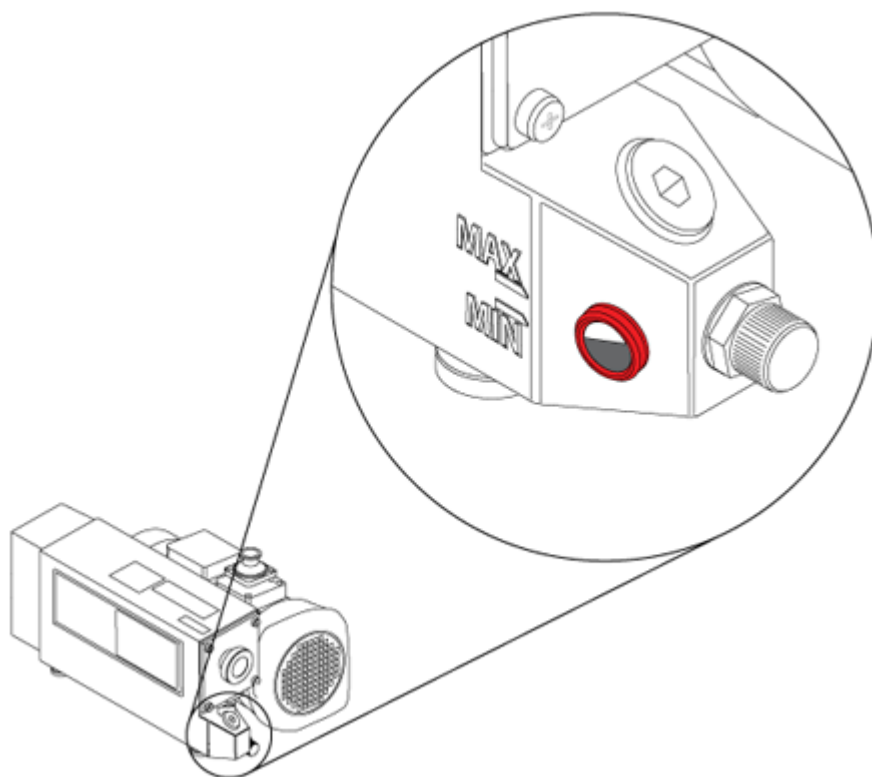

Storage and Handling



WARNING! Environmental Hazard. Do not discard system components in municipal waste. To discard components correctly, obey local regulations.

If the mass spectrometer must be stored for a long time or prepared for shipping, then contact a SCIEX FSE for decommissioning information. To disconnect power from the mass spectrometer, remove the mains supply connector from the AC mains supply.

Note: The ion source and mass spectrometer must be transported and stored at a temperature between $-30\text{ }^{\circ}\text{C}$ to $+60\text{ }^{\circ}\text{C}$ ($-22\text{ }^{\circ}\text{F}$ to $140\text{ }^{\circ}\text{F}$) and relative humidity not exceeding 99%, non-condensing. Store the system at an altitude not exceeding 2,000 m (6,562 ft) above sea level.

Move the Mass Spectrometer



WARNING! Lifting Hazard. Use a mechanical lifting device to lift and move the mass spectrometer. If the mass spectrometer must be moved manually, then at least 11 people are required to move the system safely. Follow established safe lifting procedures. We recommend the use of a professional moving service. For the weights of system components, refer to the document: *Site Planning Guide*.



WARNING! Lifting Hazard. Make sure that at least two people are available to lift the roughing pump. Follow established safe lifting procedures.



WARNING! Hot Surface Hazard. Beware of burns. Allow the surfaces of the mass spectrometer to cool sufficiently before contact.

Prerequisites

- Shut down the system. It is not necessary to vent the system. Refer to the section: [Shut Down and Vent the System](#).
- Turn off all of the gas flows, and then relieve the pressure in the gas lines.

Required Materials

- Lifting kit

1. Disconnect the vacuum hose, gas tubing, source exhaust tubing, power cable, and Ethernet cable from the mass spectrometer. Refer to the figure: [Figure 3-3](#).
2. Open the dress panel. Refer to the section: [Open the Dress Panel](#).
The right skirt can only be removed after the dress panel is opened.
3. Remove the left and right skirts. Each skirt is held in position with three magnets.
4. Close the dress panel.
5. On the right front side of the mass spectrometer, pull out the locking pin that attaches the lifting bar, pull out the bar until the hole in the bar lines up with the hole in the tube, and then attach the bar with the locking pin.

Figure 5-8 Lifting Bar Retracted



6. Repeat step 5 at the right back, left front, and left back of the mass spectrometer.
7. Install a short block on each lifting bar, and then attach it with a locking pin.

CAUTION: Potential System Damage. Make sure that all locking pins are fully inserted, to avoid dropping the mass spectrometer while it is being moved.

Figure 5-9 Short Block Installed



8. On the right side of the mass spectrometer, insert a long rod through the blocks.

Note: The ends of the long rods must extend a greater distance at the back of the mass spectrometer. The front end of the long rods are marked.

9. Repeat step 8 on the left side of the mass spectrometer.
10. Install the locking pins in the long rods.

Figure 5-10 Installing the Locking Pin in the Long Rod



11. Install the tall blocks on the ends of the long rods at the back of the mass spectrometer, and then attach the blocks with two locking pins.

Figure 5-11 Tall Block Installed



12. At the back of the mass spectrometer, insert a short rod through the tall blocks.
13. Attach the short rods with two locking pins.

Figure 5-12 Installing the Locking Pin in the Short Rod

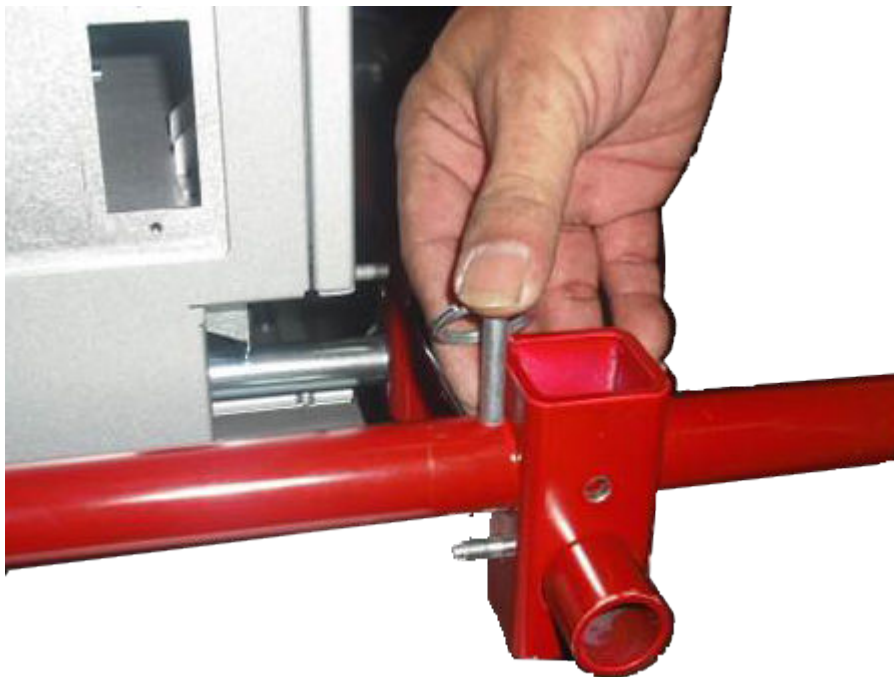
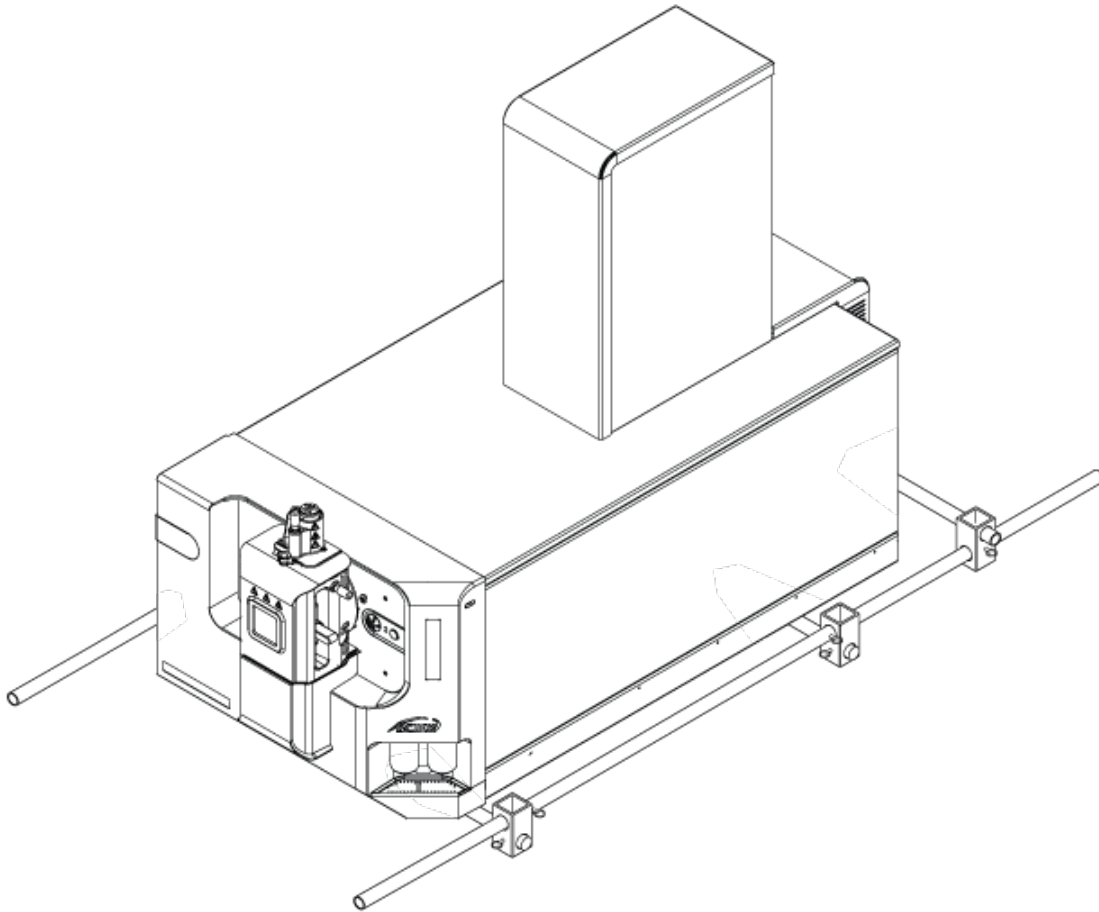
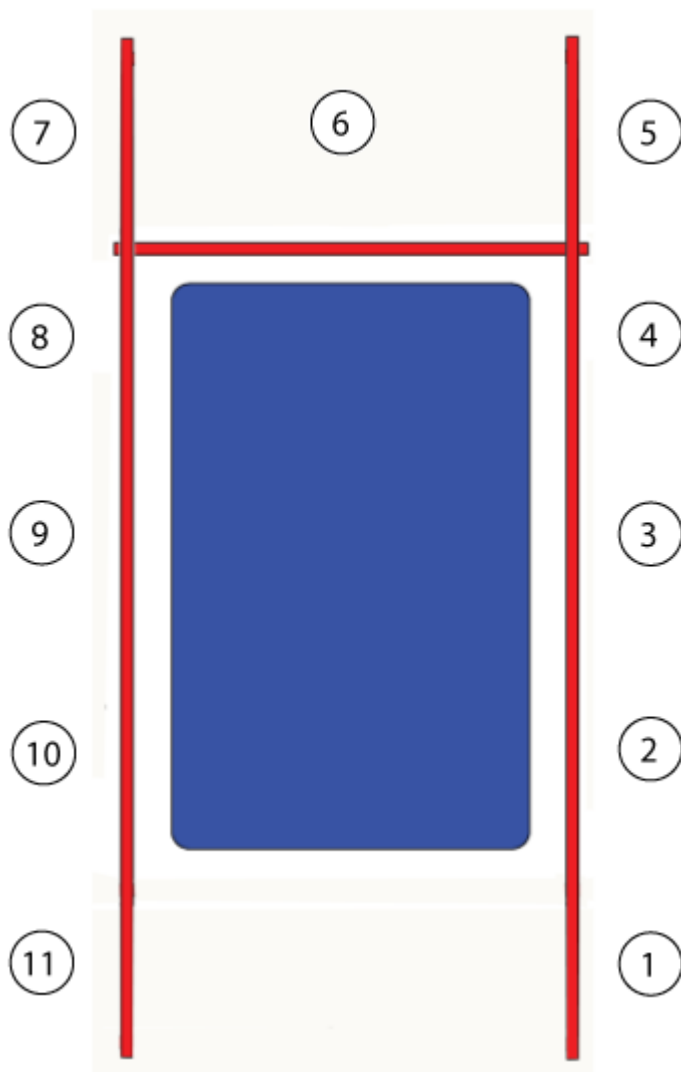

Figure 5-13 Lifting Kit Installed



14. With the assistance of 10 additional people (11 people in total), lift the mass spectrometer together and then move it to the new location.

Figure 5-14 Distribution of Operators



15. With the assistance of one additional person, move the roughing pump to the new location.
16. Disassemble the lifting kit.
17. Retract the lifting bars into the mass spectrometer chassis, and then insert the locking pins.
18. Open the dress panel. Refer to the section: [Open the Dress Panel](#).
19. Install the left and right skirts.
20. Close the dress panel.
21. Connect the vacuum hose, gas tubing, source exhaust tubing, power cable, and Ethernet cable to the mass spectrometer.

CAUTION: Potential System Damage. Make sure that the vacuum hose clamp is oriented so that it does not protrude past the side of the mass spectrometer. If it is oriented incorrectly, then it might damage the dress panel when the dress panel is opened to service the mass spectrometer.

Figure 5-15 Correctly Installed Clamp



Open the Dress Panel

Prerequisite Procedures

- Remove the ion source. Refer to the ion source document: *Operator Guide*.

Required Materials

- Flat-bladed screwdriver
-
- Insert a screwdriver through the hole in the front dress panel to release the locking pin, remove the screwdriver, and then open the dress panel from the right side.

Figure 5-16 Hole in Front Dress Panel

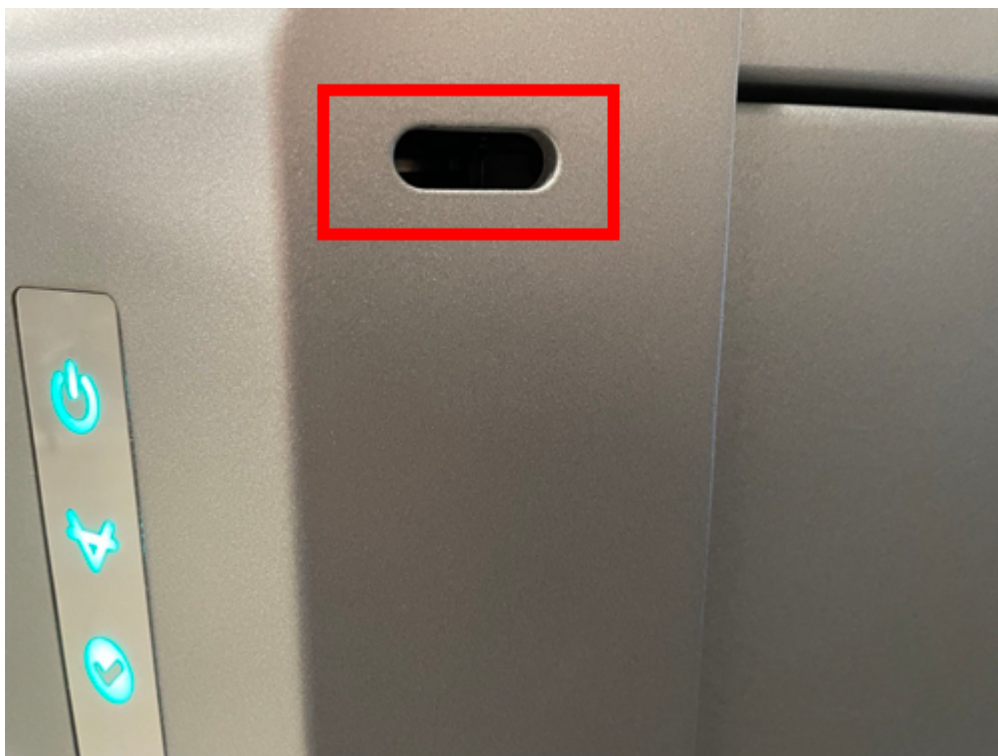

Mass Spectrometer Troubleshooting 6

This section contains information for troubleshooting basic system issues. Certain activities can only be carried out by a SCIEX-trained qualified maintenance person (QMP) in the laboratory. For advanced troubleshooting, contact a SCIEX field service employee (FSE).

Table 6-1 System Issues

Symptom	Possible Cause	Corrective Action
The QJet ion guide is extremely dirty or frequently becomes dirty.	The flow rate of the gas for the Curtain Gas interface is too low.	Examine the setting for the gas for the Curtain Gas interface and increase it, if applicable.
A system fault has occurred because the vacuum pressure is too high.	<ol style="list-style-type: none">1. Oil-sealed roughing pump: The oil level is too low.2. There is a leak.3. The wrong orifice plate is installed.	<ol style="list-style-type: none">1. Oil-sealed roughing pump: Inspect the oil level in the roughing pump, and then contact the local QMP or an FSE to add oil. Refer to the section: Inspect the Roughing Pump Oil Level (Oil-Sealed Roughing Pump).2. Inspect and repair leaks.3. Install the correct orifice plate.
The mass spectrometer does not pump down to the correct base pressure.	There is a leak in the area of the orifice plate.	<ul style="list-style-type: none">• Remove and then reinstall the orifice plate, or replace it if it is cracked.• Inspect all vacuum connections and vacuum seals.

Mass Spectrometer Troubleshooting

Table 6-1 System Issues (continued)

Symptom	Possible Cause	Corrective Action
<p>The mass spectrometer takes an excessive amount of time to pump down properly.</p> <p>Note: The mass spectrometer reaches the base pressure only when the aperture in the orifice plate is plugged. After the aperture is unplugged, the mass spectrometer base pressure increases rapidly and the mass spectrometer goes into pump down mode.</p>	<ol style="list-style-type: none"> 1. The turbo pump controller is defective. 2. The orifice plate is not sealed properly. 	<ol style="list-style-type: none"> 1. Replace the turbo pump controller. 2. Do the following steps to seal the orifice plate properly: <ol style="list-style-type: none"> a. Press and hold the orifice plate in place to seal it. b. If the orifice plate is not sealed, then remove and reinstall it. c. Replace the orifice plate if it cannot be sealed properly.
<p>A system fault has occurred because the QPS exciter module temperature is too high.</p>	<ol style="list-style-type: none"> 1. The ambient temperature is too high. 	<ol style="list-style-type: none"> 1. Contact the local FSE. 2. For the ambient temperature specifications, refer to the mass spectrometer document: <i>Site Planning Guide</i>.
<p>The control software reports that the mass spectrometer is in Fault status because of the ion source.</p>	<ol style="list-style-type: none"> 1. The probe is not installed. 2. The probe is not connected securely. 	<p>Confirm the fault in the Status panel of the device details page.</p> <ol style="list-style-type: none"> 1. Install the probe. Refer to the ion source document: <i>Operator Guide</i>. 2. Remove and then install the probe. Tighten the retaining ring securely. Refer to the ion source document: <i>Operator Guide</i>.

Table 6-1 System Issues (continued)

Symptom	Possible Cause	Corrective Action
The control software indicates that the APCI probe is in use, but the TurbolonSpray probe is installed.	The F3 fuse is blown.	Contact an FSE.
The spray is not uniform.	The electrode is blocked.	Clean or replace the electrode. Refer to the ion source document: <i>Operator Guide</i> .
The interface heater is not ready.	The interface heater is faulty.	Contact the local QMP or FSE.
The mass spectrometer resolution is poor.	The mass spectrometer is not tuned.	Use the control software to optimize the mass spectrometer. Refer to the document: <i>Help System</i> .
The mass spectrometer performance has degraded.	<ol style="list-style-type: none"> 1. The ion source conditions are not optimized. 2. The sample was not prepared correctly or the sample has degraded. 3. The sample inlet fittings are leaking. 	<ol style="list-style-type: none"> 1. Optimize the ion source conditions. Refer to the document: <i>Help System</i>. 2. Confirm that the sample was prepared correctly. 3. Verify that the fittings are the right size and type and make sure that they are tight. Do not overtighten the fittings. Replace the fittings if leaks continue. 4. Install and optimize an alternate ion source. 5. Contact an FSE if the issue persists.

Mass Spectrometer Troubleshooting

Table 6-1 System Issues (continued)

Symptom	Possible Cause	Corrective Action
Arcing or sparks occur.	The position of the corona discharge needle is incorrect.	If the TurbolonSpray probe is being used, then turn the corona discharge needle toward the curtain plate and away from the stream of heater gas. Refer to the ion source document: <i>Operator Guide</i> .

Table 6-2 Sensitivity Is Decreased

Possible Cause	Corrective Action
The ion source parameters are not optimized.	Optimize the ion source parameters. Refer to the document: <i>Help System</i> .
The mass spectrometer is not optimized.	Use the control software to optimize the mass spectrometer. Refer to the document: <i>Help System</i> .
The curtain plate is dirty.	Clean the curtain plate. Refer to the section: Clean the Curtain Plate .
The orifice plate is dirty.	Clean the orifice plate. Refer to the section: Clean the Front of the Orifice Plate or contact the local QMP or FSE.
The QJet ion guide or IQ0 lens is dirty.	Clean the QJet ion guide and IQ0 lens. Contact the local QMP or FSE.
The Q0 region is dirty.	Do a test for contamination of the Q0 region. Contact the local QMP or FSE.
The sample line is leaking.	Inspect the sample line for leaks and repair any leaks found. Make sure that all fittings are the correct type and size.
The sample has degraded or has a low concentration.	Make sure that the sample concentration is correct. Use a fresh sample.
The nut that secures the electrodes on the ion source probe is not tight.	Tighten the nut that secures the electrodes.
The probe is not installed properly.	Remove and install the probe. Refer to the ion source document: <i>Operator Guide</i> .

Table 6-2 Sensitivity Is Decreased (continued)

Possible Cause	Corrective Action
The ion source is not installed properly or it is faulty.	Remove and install the ion source, making sure that the latches are properly secured. If this does not resolve the issue, then install and optimize an alternate ion source. Refer to the ion source document: <i>Operator Guide</i> .
One or more of the O-rings on the vacuum interface is missing.	If the O-rings are on the ion source, then install them on the vacuum interface. If they are missing, then replace them.
There is an issue with the LC system or connections.	Troubleshoot the LC system.
The declustering potential (DP) is not optimized.	Optimize the DP.
The electrode is dirty or blocked.	Replace the electrode. Refer to the ion source document: <i>Operator Guide</i> .

Table 6-3 No Signal or Signal Is Unstable

Possible Cause	Corrective Action
The sample tubing is blocked.	Replace the sample tubing. Refer to the ion source document: <i>Operator Guide</i> .
The calibrant signal is low. 1. The CDS is not connected. 2. The CDS tubing is blocked.	1. Check the CDS connections. 2. Inspect the calibrant tubing for blockages.

Table 6-4 Background Noise Issues

Possible Cause	Corrective Action
The ion source temperature, spray voltage, or flow rate for ion source gas 2 (heater gas) is too high.	Optimize the ion source parameters. Refer to the document: <i>Turbo V Ion Source Operator Guide</i> .
The sample line is dirty.	Clean or replace the sample line.
The curtain plate is dirty.	Clean the curtain plate. Refer to the section: Clean the Curtain Plate .

Mass Spectrometer Troubleshooting

Table 6-4 Background Noise Issues (continued)

Possible Cause	Corrective Action
The orifice plate is dirty.	Clean the front of the orifice plate. Refer to the section: Clean the Front of the Orifice Plate .
The QJet ion guide or IQ0 lens is dirty.	Do a full cleaning of the front-end components of the mass spectrometer. Contact the local QMP or FSE.
The Q0 region is dirty.	Clean the Q0 region. Contact the QMP or FSE.
The mobile phase is contaminated.	Replace the mobile phase.
The ion source is contaminated.	Clean or replace the ion source components and then condition the ion source and front end: <ol style="list-style-type: none">1. Move the probe to the furthest position from the aperture, vertically and horizontally.2. Infuse or inject 50:50 methanol:water with a pump flow rate of 1 mL/min.3. In the control software, set the temperature to 650, ion source gas 1 to 60, and ion source gas 2 to 60.4. Set the flow rate for the gas for the Curtain Gas interface to 45 or 50.5. Run for a minimum of 2 hours, or preferably overnight, for best results.

For sales, technical assistance, or service, contact an FSE or visit the SCIEX website at sciex.com for contact information.

Recommended Calibration Ions

A

The following table list the standards recommended by SCIEX for calibrating the ZenoTOF 7600+ system.

CAUTION: Potential Wrong Result. Do not use expired solutions or solutions that have not been stored at the indicated storage temperature.

Table A-1 Calibration Solutions

Part Number	Description	Quantity
5049910	ESI Positive Calibration Solution X500 B	100 mL
5042913	ESI Negative Calibration Solution X500	100 mL
5032735	ESI Positive Calibration Solution X500 — 5 Pack	5 × 100 mL
5042917	ESI Negative Calibration Solution X500 — 5 Pack	5 × 100 mL
5042914	APCI Positive Calibration Solution X500	100 mL
5042915	APCI Negative Calibration Solution X500	100 mL
5042918	APCI Positive Calibration Solution X500 — 5 Pack	5 × 100 mL
5042919	APCI Negative Calibration Solution X500 — 5 Pack	5 × 100 mL
5033025	Calibration Solution Suite for the SCIEX X500 B system <ul style="list-style-type: none">• ESI Positive Calibration Solution X500 B• ESI Negative Calibration Solution X500• APCI Positive Calibration Solution X500• APCI Negative Calibration Solution X500	4 × 100 mL

APCI Calibration Ions

Table A-2 TOF MS Positive Calibration Ions

Masses				
146.1176	266.1598	315.1623	354.2122	442.2647
609.2807	618.3695	922.0098	1521.9715	

Recommended Calibration Ions

Table A-3 TOF MS Negative Calibration Ions

Masses							
144.1030	264.1453	277.0983	352.1977	403.1122	440.2501	616.3550	792.4598

Table A-4 TOF MS/MS Positive Product Ions

Precursor Ion (m/z)	315.1623	609.2807
Declustering potential (V)	80	80
Collision energy (V)	27	45
Fragment ion 1	315.1623	609.2807
Fragment ion 2	270.1044	577.2544
Fragment ion 3	242.0731	448.1966
Fragment ion 4	235.1356	397.2122
Fragment ion 5	227.0496	365.1860
Fragment ion 6	220.1121	236.1281
Fragment ion 7	86.0964	195.0652
Fragment ion 8	58.0651	174.0913

Table A-5 TOF MS/MS Negative Product Ions

Precursor Ion (m/z)	277.0983	403.1122
Declustering potential (V)	-80	-80
Collision energy (V)	-30	-30
Fragment ion 1	277.0983	403.1122
Fragment ion 2	249.1033	277.0983
Fragment ion 3	217.0771	158.0611
Fragment ion 4	200.0591	125.0067
Fragment ion 5	158.0611	93.0344
Fragment ion 6	130.0662	N/A
Fragment ion 7	116.0506	N/A
Fragment ion 8	77.0397	N/A

ESI Calibration Ions

Table A-6 TOF MS Positive Calibration Ions

Masses						
132.9049	266.1598	315.1623	354.2122	442.2647	609.2807	829.5393
922.0098	1053.9074	1521.9715	1643.8691	2121.9332	2130.2449	2253.8308

Table A-7 TOF MS Negative Calibration Ions

Masses						
68.9958	112.9856	154.9738	204.9706	248.9604	384.9352	520.9100
656.8848	792.8596	928.8344	1064.8092	1200.7841	1336.7589	1472.7337
1608.7085	1744.6833	1565.9624	1633.9498	1880.6581	2165.9241	2233.9115

Table A-8 TOF MS/MS Positive Product Ions

Precursor ion (<i>m/z</i>)	315.1623	609.2807	829.5393
Declustering potential (V)	80	80	80
Collision energy (V)	25	45	45
Fragment ion 1	315.162	609.281	829.539
Fragment ion 2	270.104	577.254	811.529
Fragment ion 3	242.073	448.197	724.497
Fragment ion 4	235.136	397.212	706.486
Fragment ion 5	227.05	365.186	607.418
Fragment ion 6	220.112	236.128	532.334
Fragment ion 7	86.0964	195.065	512.344
Fragment ion 8	58.0651	174.091	494.334
			411.297
			399.26
			381.25
			298.213
			268.166

Recommended Calibration Ions

Table A-8 TOF MS/MS Positive Product Ions (continued)

Precursor Ion (<i>m/z</i>)	315.1623	609.2807	829.5393
			227.175
			215.139
			185.129
			157.134

Table A-9 TOF MS/MS Negative Product Ions

Precursor Ion (<i>m/z</i>)	248.9	384.9	520.9	792.8	1200.784
Declustering potential (V)	80	80	80	80	80
Collision energy (V)	15	16	20	22	30
Fragment ion 1	248.9604	384.9352	520.9100	792.8596	1200.784
Fragment ion 2	204.9706	248.9604	384.9352	656.8848	1064.809
Fragment ion 3	154.9738	204.9706	248.9604	520.9100	928.8344
Fragment ion 4	112.9856	154.9738	204.9706	384.9352	792.8596
Fragment ion 5	68.99576	112.9856	154.9738	248.9604	656.8848
Fragment ion 6	N/A	N/A	112.9856	204.9706	520.9100
Fragment ion 7	N/A	N/A	N/A	154.9738	384.9352
Fragment ion 8	N/A	N/A	N/A	112.9856	248.9604
	N/A	N/A	N/A		204.9706
	N/A	N/A	N/A		154.9738

Exact Masses and Chemical Formulas

B

Reserpine

Table B-1 Reserpine Exact Masses (C₃₃H₄₀N₂O₉)

Description	Mass
Molecular Ion C ₃₃ H ₄₁ N ₂ O ₉	609.28066
Fragment C ₂₃ H ₃₀ NO ₈	448.19659
Fragment C ₂₃ H ₂₉ N ₂ O ₄	397.21218
Fragment C ₂₂ H ₂₅ N ₂ O ₃	365.18597
Fragment C ₁₃ H ₁₈ NO ₃	236.12812
Fragment C ₁₀ H ₁₁ O ₄	195.06519
Fragment C ₁₁ H ₁₂ NO	174.09134

Peptide ALILTLVS

Table B-2 Peptide ALILTLVS Exact Mass

Name	Sequence	Mass	Charge State
Precursor ion	ALILTLVS	829.5393	1+
b8	ALILTLVS	811.5288	1+
b7	ALILTLV	724.4967	1+
b7-18	ALILTLV	706.4862	1+
b6-18	ALILTLV	607.4178	1+
y5	LTLVS	532.3341	1+
b5	ALILT	512.3443	1+
b5-18	ALILT	494.3337	1+
b4	ALIL	411.2966	1+
b3	ALI	298.2125	1+

Exact Masses and Chemical Formulas









Table B-2 Peptide ALILTLVS Exact Mass (continued)

Name	Sequence	Mass	Charge State
Internal fragment y b	IL or LI	227.1754	1+
Internal fragment y b	LT or TL	215.139	1+
b2	AL	185.1285	1+
a2	AL	157.1335	1+
Immonium ions	I or L	86.09643	1+









Glossary of Symbols











C

Note: Not all of the symbols in the following table are applicable to every instrument.



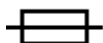







Symbol	Description
	Australian Regulatory Compliance Mark. Indicates that the product complies with Australian Communications Media Authority (ACMA) EMC and Electrical Safety Requirements.
	Alternating current
A	Amperes (current)
	Asphyxiation Hazard
	Authorized representative in the European community
	Biohazard
	CE Marking of Conformity
	cCSAus mark. Indicates electrical safety certification for Canada and USA.
	Catalog number









Glossary of Symbols

Symbol	Description
	<p>Caution. Consult the instructions for information about a possible hazard.</p> <hr/> <p>Note: In SCIEX documentation, this symbol identifies a personal injury hazard.</p>
	<p>China RoHS Caution Label. The electronic information product contains certain toxic or hazardous substances. The center number is the Environmentally Friendly Use Period (EFUP) date, and indicates the number of calendar years the product can be in operation. Upon the expiration of the EFUP, the product must be immediately recycled. The circling arrows show the product is recyclable. The date code on the label or product indicates the date of manufacture.</p>
	<p>China RoHS logo. The device does not contain toxic and hazardous substances or elements above the maximum concentration values and the device is an environmentally-friendly product that can be recycled and reused.</p>
	<p>Consult instructions for use.</p>
	<p>Crushing Hazard</p>
	<p>cTUVus mark for TUV Rheinland of North America</p>
	<p>Data Matrix symbol that can be scanned by a barcode reader to obtain a unique device identifier (UDI)</p>
	<p>Environmental Hazard</p>





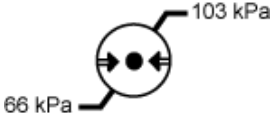
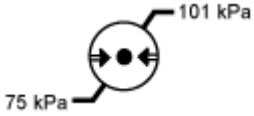
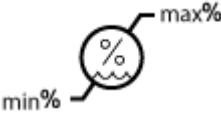

Symbol	Description
	Ethernet connection
	Explosion Hazard
	Eye Injury Hazard
	Fire Hazard
	Flammable Chemical Hazard
	Fragile
	Fuse
Hz	Hertz
	International safety symbol Caution, risk of electric shock (ISO 3864), also known as High Voltage symbol If the main cover must be removed, then contact a SCIEX representative to prevent electric shock.
	Hot Surface Hazard
	In Vitro Diagnostic Device

Glossary of Symbols

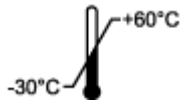
Symbol	Description
	Ionizing Radiation Hazard
	Keep dry. Do not expose to rain. Relative humidity must not exceed 99%.
	Keep upright.
	Lacerate/Sever Hazard
	Laser Radiation Hazard
	Lifting Hazard
	Magnetic Hazard
	Manufacturer
	Moving Parts Hazard
	Pacemaker Hazard. No access to people with pacemakers.

Symbol	Description
	Pinching Hazard
	Pressurized Gas Hazard
	Protective Earth (ground)
	Puncture Hazard
	Reactive Chemical Hazard
	Serial number
	Toxic Chemical Hazard
	Transport and store the system within 66 kPa to 103 kPa.
	Transport and store the system within 75 kPa to 101 kPa.
	Transport and store the system within the specified minimum (min) and maximum (max) levels of relative humidity, noncondensing.
	Transport and store the system within $-30\text{ }^{\circ}\text{C}$ to $+45\text{ }^{\circ}\text{C}$.

Glossary of Symbols

Symbol	Description
	Transport and store the system within $-30\text{ }^{\circ}\text{C}$ to $+60\text{ }^{\circ}\text{C}$.
	USB 2.0 connection
	USB 3.0 connection
	Ultraviolet Radiation Hazard
	United Kingdom Conformity Assessment Mark
UKRP	United Kingdom Responsible Person
VA	Volt Ampere (apparent power)
V	Volts (voltage)
	WEEE. Do not dispose of equipment as unsorted municipal waste. Environmental Hazard
W	Watts (power)
	<i>yyyy-mm-dd</i> Date of manufacture

Glossary of Warnings

D

Note: If any of the labels used to identify a component become detached, then contact a SCIEX field service employee (FSE).

Label	Translation (if applicable)
FOR RESEARCH USE ONLY. NOT FOR USE IN DIAGNOSTIC PROCEDURES.	FOR RESEARCH USE ONLY. NOT FOR USE IN DIAGNOSTIC PROCEDURES.
<p>HANDLE WITH CARE</p> <p>WARNING 50g</p> <p>SHOCK INDICATOR</p> <p>ROUGH HANDLING WILL CHANGE INDICATOR TO RED</p> <p>If indicator is RED, note on the bill of lading, inspection may be warranted</p>	<p>HANDLE WITH CARE</p> <p>WARNING 50g</p> <p>SHOCK INDICATOR</p> <p>ROUGH HANDLING WILL CHANGE INDICATOR TO RED</p> <p>If indicator is RED, note on the bill of lading, inspection may be warranted</p> <hr/> <p>Note: If the indicator is tripped, then this container has been dropped or otherwise mishandled. Make a note on the Bill of Lading and then check for damage. Any claims for shock damage require a notation.</p>
<p>IMPORTANT!</p> <p>RECORD ANY VISIBLE CRATE DAMAGE, INCLUDING TRIPPED IMPACT-O-GRAPH OR TIP-N-TELL INDICATORS, ON THE WAYBILL BEFORE ACCEPTING SHIPMENT.</p> <p>NOTIFY YOUR LOCAL SCIEX CUSTOMER SUPPORT ENGINEER IMMEDIATELY.</p>	<p>IMPORTANT!</p> <p>RECORD ANY VISIBLE CRATE DAMAGE, INCLUDING TRIPPED IMPACT-O-GRAPH OR TIP-N-TELL INDICATORS, ON THE WAYBILL BEFORE ACCEPTING SHIPMENT.</p> <p>NOTIFY YOUR LOCAL SCIEX CUSTOMER SUPPORT ENGINEER IMMEDIATELY.</p>

Glossary of Warnings

Label	Translation (if applicable)
TIP & TELL	<p>Tilt Indicator</p> <hr/> <p>Note: Indicates whether the container was tipped or mishandled. Write on the Bill of Lading and inspect for damage. Any claims for tipping require a notation.</p> <hr/>
TiltWatch PLUS ShockWatch	<p>Tilt Indicator</p> <hr/> <p>Note: Indicates whether the container was tipped or mishandled. Write on the Bill of Lading and inspect for damage. Any claims for tipping require a notation.</p> <hr/>
WARNING: DO NOT OPERATE WITHOUT FIRST ENSURING BOTTLE CAP IS SECURED.	<p>WARNING: DO NOT OPERATE WITHOUT FIRST ENSURING BOTTLE CAP IS SECURED.</p> <hr/> <p>Note: This warning is attached to the source exhaust drain bottle.</p> <hr/>
WARNING: Lifting Hazard. ELEVEN PERSONS REQUIRED TO LIFT THIS EQUIPMENT.	<p>WARNING: Lifting Hazard. ELEVEN PERSONS REQUIRED TO LIFT THIS EQUIPMENT.</p>
WARNING: NO USER SERVICEABLE PARTS INSIDE. REFER SERVICING TO QUALIFIED PERSONNEL.	<p>WARNING: NO USER SERVICEABLE PARTS INSIDE. REFER SERVICING TO QUALIFIED PERSONNEL.</p> <hr/> <p>Note: Consult instructions for use.</p> <hr/>

Contact Us

Customer Training

- In North America: NA.CustomerTraining@sciex.com
- In Europe: Europe.CustomerTraining@sciex.com
- Outside the EU and North America, visit sciex.com/education for contact information.

Online Learning Center

- [SCIEX Now Learning Hub](#)

SCIEX Support

SCIEX and its representatives maintain a staff of fully-trained service and technical specialists located throughout the world. They can answer questions about the system or any technical issues that might arise. For more information, visit the SCIEX website at sciex.com or contact us in one of the following ways:

- sciex.com/contact-us
- sciex.com/request-support

Cybersecurity

For the latest guidance on cybersecurity for SCIEX products, visit sciex.com/productsecurity.

Documentation

This version of the document supersedes all previous versions of this document.

To see this document electronically, Adobe Acrobat Reader is required. To download the latest version, go to <https://get.adobe.com/reader>.

To find software product documentation, refer to the release notes or software installation guide that comes with the software.

To find hardware product documentation, refer to the documentation that comes with the system or component.

The latest versions of the documentation are available on the SCIEX website, at sciex.com/customer-documents.

Contact Us

Note: To request a free, printed version of this document, contact sciex.com/contact-us.
